

---

**ADVANTEST®**  
ADVANTEST CORPORATION

---

*R3465 Series*

*Modulation Spectrum Analyzer*

*Operation Manual*

MANUAL NUMBER FOE-8311219H02

---

*Applicable models*

- R3463
- R3465



---

## Safety Summary

To ensure thorough understanding of all functions and to ensure efficient use of this instrument, please read the manual carefully before using. Note that Advantest bears absolutely no responsibility for the result of operations caused due to incorrect or inappropriate use of this instrument.

If the equipment is used in a manner not specified by Advantest, the protection provided by the equipment may be impaired.

- **Warning Labels**

Warning labels are applied to Advantest products in locations where specific dangers exist. Pay careful attention to these labels during handling. Do not remove or tear these labels. If you have any questions regarding warning labels, please ask your nearest Advantest dealer. Our address and phone number are listed at the end of this manual.

Symbols of those warning labels are shown below together with their meaning.

**DANGER:** Indicates an imminently hazardous situation which will result in death or serious personal injury.

**WARNING:** Indicates a potentially hazardous situation which will result in death or serious personal injury.

**CAUTION:** Indicates a potentially hazardous situation which will result in personal injury or a damage to property including the product.

- **Basic Precautions**

Please observe the following precautions to prevent fire, burn, electric shock, and personal injury.

- Use a power cable rated for the voltage in question. Be sure however to use a power cable conforming to safety standards of your nation when using a product overseas.
- When inserting the plug into the electrical outlet, first turn the power switch OFF and then insert the plug as far as it will go.
- When removing the plug from the electrical outlet, first turn the power switch OFF and then pull it out by gripping the plug. Do not pull on the power cable itself. Make sure your hands are dry at this time.
- Before turning on the power, be sure to check that the supply voltage matches the voltage requirements of the instrument.
- Connect the power cable to a power outlet that is connected to a protected ground terminal. Grounding will be defeated if you use an extension cord which does not include a protected ground terminal.
- Be sure to use fuses rated for the voltage in question.
- Do not use this instrument with the case open.
- Do not place anything on the product and do not apply excessive pressure to the product. Also, do not place flower pots or other containers containing liquid such as chemicals near this

product.

- When the product has ventilation outlets, do not stick or drop metal or easily flammable objects into the ventilation outlets.
- When using the product on a cart, fix it with belts to avoid its drop.
- When connecting the product to peripheral equipment, turn the power off.

- **Caution Symbols Used Within this Manual**

Symbols indicating items requiring caution which are used in this manual are shown below together with their meaning.

**DANGER:** Indicates an item where there is a danger of serious personal injury (death or serious injury).

**WARNING:** Indicates an item relating to personal safety or health.

**CAUTION:** Indicates an item relating to possible damage to the product or instrument or relating to a restriction on operation.

- **Safety Marks on the Product**

The following safety marks can be found on Advantest products.



: ATTENTION - Refer to manual.



: Protective ground (earth) terminal.



: DANGER - High voltage.



: CAUTION - Risk of electric shock.

- **Replacing Parts with Limited Life**

The following parts used in the instrument are main parts with limited life.

Replace the parts listed below before their expected lifespan has expired to maintain the performance and function of the instrument.

Note that the estimated lifespan for the parts listed below may be shortened by factors such as the environment where the instrument is stored or used, and how often the instrument is used.

The parts inside are not user-replaceable. For a part replacement, please contact the Advantest sales office for servicing.

Each product may use parts with limited life.

For more information, refer to the section in this document where the parts with limited life are described.

## Main Parts with Limited Life

Part name	Life
Unit power supply	5 years
Fan motor	5 years
Electrolytic capacitor	5 years
LCD display	6 years
LCD backlight	2.5 years
Floppy disk drive	5 years
Memory backup battery	5 years

- **Hard Disk Mounted Products**

The operational warnings are listed below.

- Do not move, shock and vibrate the product while the power is turned on.  
Reading or writing data in the hard disk unit is performed with the memory disk turning at a high speed. It is a very delicate process.
- Store and operate the products under the following environmental conditions.  
An area with no sudden temperature changes.  
An area away from shock or vibrations.  
An area free from moisture, dirt, or dust.  
An area away from magnets or an instrument which generates a magnetic field.
- Make back-ups of important data.  
The data stored in the disk may become damaged if the product is mishandled. The hard disc has a limited life span which depends on the operational conditions. Note that there is no guarantee for any loss of data.

- **Precautions when Disposing of this Instrument**

When disposing of harmful substances, be sure dispose of them properly with abiding by the state-provided law.

Harmful substances: (1) PCB (polycarbon biphenyl)  
(2) Mercury  
(3) Ni-Cd (nickel cadmium)  
(4) Other  
Items possessing cyan, organic phosphorous and hexadic chromium and items which may leak cadmium or arsenic (excluding lead in solder).

Example: fluorescent tubes, batteries

---

# Environmental Conditions

This instrument should be only be used in an area which satisfies the following conditions:

- An area free from corrosive gas
- An area away from direct sunlight
- A dust-free area
- An area free from vibrations
- Altitude of up to 2000 m

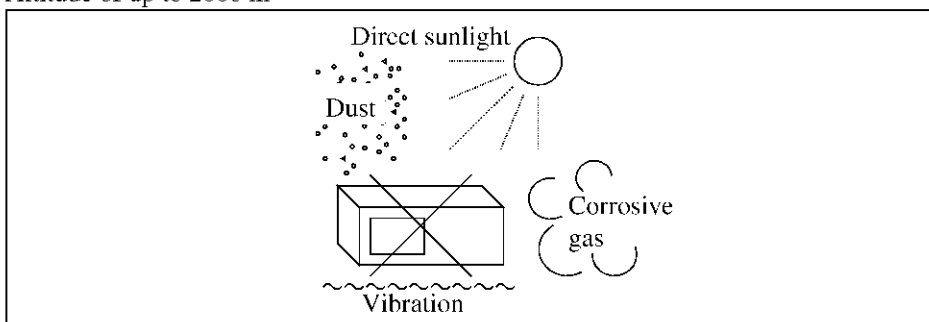

**Figure-1 Environmental Conditions**

- Operating position

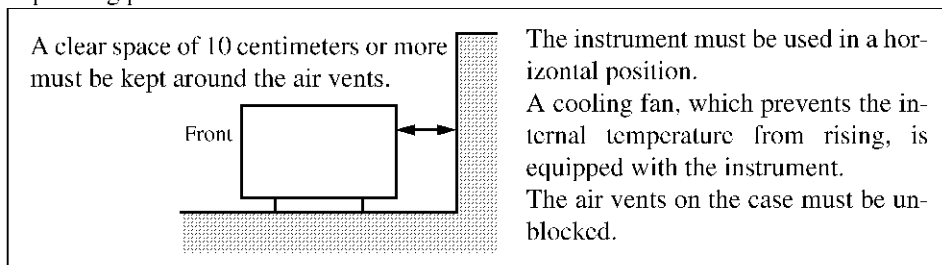

**Figure-2 Operating Position**

- Storage position

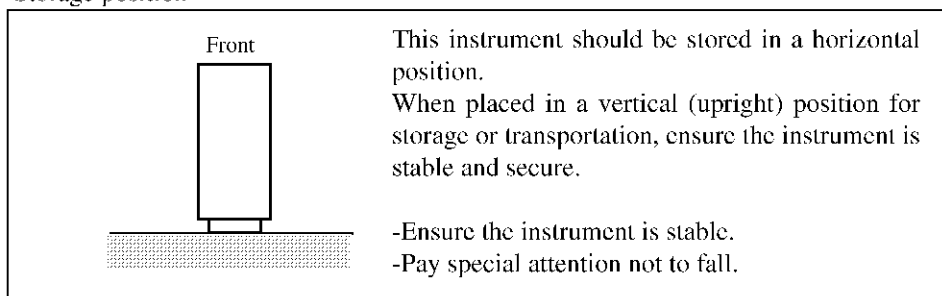

**Figure-3 Storage Position**

- The classification of the transient over-voltage, which exists typically in the main power supply, and the pollution degree is defined by IEC61010-1 and described below.

Impulse withstand voltage (over-voltage) category II defined by IEC60364-4-443

Pollution Degree 2

## Types of Power Cable

Replace any references to the power cable type, according to the following table, with the appropriate power cable type for your country.

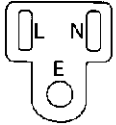
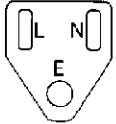
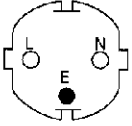
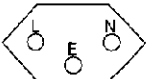
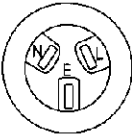
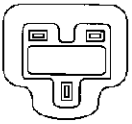
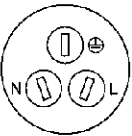
Plug configuration	Standards	Rating, color and length	Model number (Option number)
	PSE: Japan  Electrical Appliance and Material Safety Law	125 V at 7 A Black 2 m (6 ft)	Straight: A01402  Angled: A01412
	UL: United States of America  CSA: Canada	125 V at 7 A Black 2 m (6 ft)	Straight: A01403 (Option 95)  Angled: A01413
	CEE: Europe DEMKO: Denmark NEMKO: Norway VDE: Germany KEMA: The Netherlands CEBEC: Belgium OVE: Austria FIMKO: Finland SEMKO: Sweden	250 V at 6 A Gray 2 m (6 ft)	Straight: A01404 (Option 96)  Angled: A01414
	SEV: Switzerland	250 V at 6 A Gray 2 m (6 ft)	Straight: A01405 (Option 97)  Angled: A01415
	SAA: Australia, New Zealand	250 V at 6 A Gray 2 m (6 ft)	Straight: A01406 (Option 98)  Angled: -----
	BS: United Kingdom	250 V at 6 A Black 2 m (6 ft)	Straight: A01407 (Option 99)  Angled: A01417
	CCC: China	250 V at 10 A Black 2 m (6 ft)	Straight: A114009 (Option 94)  Angled: A114109





# Certificate of Conformity

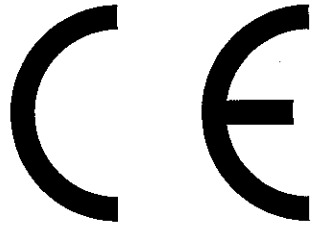

This is to certify, that

**Modulation Spectrum Analyzer**

**R3465 Series**

instrument, type, designation

complies with the provisions of the EMC Directive 89/336/EEC in accordance with EN50081-1 and EN50082-1 and Low Voltage Directive 73/23/EEC in accordance with EN61010.

**ADVANTEST Corp.**

Tokyo, Japan

**ROHDE&SCHWARZ**

Engineering and Sales GmbH

Munich, Germany



## Table of Power Cable Options

There are six power cable options (refer to following table).

Order power cable options by Model number.

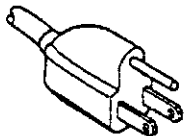
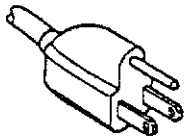
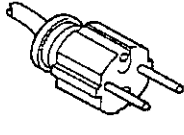
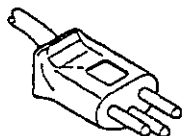
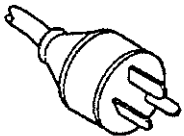
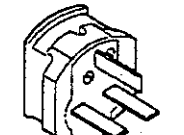
	Plug configuration	Standards	Rating, color and length	Model number (Option number)
1		JIS: Japan  Law on Electrical Appliances	125 V at 7 A Black 2 m (6 ft)	Straight: A01402  Angled: A01412
2		UL: United States of America  CSA: Canada	125 V at 7 A Black 2 m (6 ft)	Straight: A01403 (Option 95)  Angled: A01413
3		CEE: Europe DEMKO: Denmark NEMKO: Norway VDE: Germany KEMA: The Netherlands CEBEC: Belgium OVE: Austria FIMKO: Finland SEMKO: Sweden	250 V at 6 A Gray 2 m (6 ft)	Straight: A01404 (Option 96)  Angled: A01414
4		SEV: Switzerland	250 V at 6 A Gray 2 m (6 ft)	Straight: A01405 (Option 97)  Angled: A01415
5		SAA: Australia, New Zealand	250 V at 6 A Gray 2 m (6 ft)	Straight: A01406 (Option 98)  Angled: -----
6		BS: United Kingdom	250 V at 6 A Black 2 m (6 ft)	Straight: A01407 (Option 99)  Angled: A01417



***Part 1***



## PREFACE

### ■ In the Beginning

This manual explains all processes from the acceptance to actually operation of Modulation spectrum analyzer R3463/3465.

(The screen drawings use R3465 data.)

ADVANTEST reserves the right to change the content of this manual and other product information without notice.

Do not reproduce and do not reprint all of this manual or part without permission ADVANTEST Corporation. The address and the telephone number of ADVANTEST Corporation are described in the end of this manual. Refer for the inquiry etc.

### ■ How to read this manual

#### ● Notation in this manual

**Reference** : Information helpful to you. Point to a page number where it is explained.

**Note** : Uses to explain for the supplementation.

#### ● Distinction of panel key and software key in this manual

Panel key : Shows the key of the solid line frame.

(Example) 

Software key: Shows the key of the dotted line frame.

(Example) 

#### ● Notation for last page

Some pages in this manual have a "\*" mark on the upper right of page number. "\*" means that it is the last page.

## Confirmation of Product and Attachment

When you open packing, confirm the following in the beginning.  
If any flaw, damage, and shortage in the product or the attachment, etc.,  
is found, contact the nearest dealer or the sales and support office.

### ● Main unit

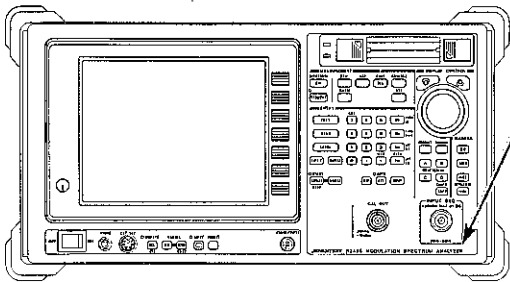

Confirmation position of type and name of product.  
Confirm the product the same as the order from the  
name plate in the front panel.

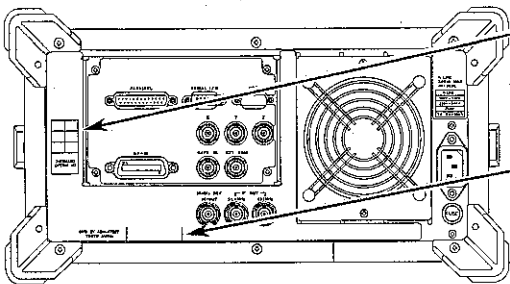

Notation for built-in optional devices  
Serial number.  
Check the serial number marked on the rear panel,  
which shall be informed to us when you ask for  
repair.



● Standard accessory lists.

**Note** Order the addition of the accessory etc. with type name.

Name of articles.	Type name	Quantity	Remarks
Power cable	*1	1	
Input cable	A01036-0150	1	50Ω BNC cable 150 mm
N-BNC conversion adapter	JUG-201A/U	1	
Fuse	T6.3A/250V	1	
R3465 SERIES Operating Manual	ER3465SERIES	1	English

\*1: ADVANTEST provides the power cables for each country.

## ■ Re-calibration

This instrument needs re-calibration of frequency standard source and CAL OUT signal.

To satisfy the accuracy of the measurement, execute the re-calibration once in a year at least.

See the page of "Guarantee" at the end of this manual for the inquiry about the re-calibration.



## TABLE OF CONTENTS

### Chapter 1 INTRODUCTION

1. Outline of Product .....	1-2
2. Operating Conditions .....	1-3
Operating environmental conditions .....	1-3
Installation .....	1-4
3. Power Source .....	1-5
Checking Power Requirements .....	1-5
Changing the supply voltage .....	1-5
Replacing the power fuse .....	1-6
Connecting the Power Cable .....	1-8
4. Cleaning, Storage and Transportation .....	1-9
Cleaning .....	1-9
Storage .....	1-9
Transportation .....	1-9
5. Notes on Use .....	1-10
Case that abnormality occurs .....	1-10
Warm up .....	1-10

### Chapter 2 DESCRIPTION OF FRONT AND REAR PANELS

1. Description of the Front Panel .....	2-2
MEASUREMENT Section .....	2-3
ENTRY Section .....	2-4
DISPLAY CONTROL Section .....	2-5
MARKER Section .....	2-6
2. Description of the Rear Panel .....	2-7

### Chapter 3 FUNDAMENTAL OPERATION

1. Initial power-on .....	3-2
Connecting to AC power source .....	3-2
Power-on .....	3-3
2. Operation keys .....	3-5
Panel keys and soft keys .....	3-5
3. Annotation on the screen .....	3-9
4. Calibration .....	3-10
5. Measuring the power level .....	3-11
6. Measurement of Frequency .....	3-15
Measurement with normal marker .....	3-15
Measurement by frequency counter .....	3-17

Convenient functions MKR $\leftrightarrow$ CF, MKR $\leftrightarrow$ REF .....	3-20
7. Dynamic Range and Sweep Rate .....	3-22

**Chapter 4 BASIC OPERATION**

1. When the Power is Turned ON .....	4-2
Reference frequency .....	4-2
Setting .....	4-2
2. When a High Level Signal Exists outside the Displayed Span .....	4-3
3. Local Feedthrough .....	4-5
4. Initialization .....	4-6

**Chapter 5 SAMPLE MEASUREMENT**

1. Measurement of Frequency .....	5-2
Sample measurement of approximately 200 MHz signal source .....	5-2
2. Measuring the modulation frequency and modulation index of AM signal .....	5-5
Sample measurement of AM wave of low modulation degree and high modulation index .....	5-6
Sample measurement of AM wave of high modulation frequency and low modulation index .....	5-10
3. Measurement of FM Wave .....	5-13
Sample measurement of FM wave of low modulation frequency .....	5-14
Sample measurement of FM wave of high modulation frequency and low m value ...	5-17
Sample measurement of the deviation of FM wave peak ( $\Delta f$ peak) .....	5-19
How to obtain m when FM modulation index m is small .....	5-22
4. Measurement of Pulse Modulated Wave ...	5-24
Pulse width ( $\tau$ ) .....	5-25
Carrier frequency ( $f_c$ ) .....	5-25
Peak power ( $P_{peak}$ ) .....	5-25
Mean power $P_{ave}$ (dBm) .....	5-25

5. Spectrum Analysis of Burst Signal .....	5-26
Measuring method .....	5-26
6. How to measure transmitter test .....	5-27
Measurement of frequency error (modulation accuracy) .....	5-27
Measurement of OBW (Occupied Bandwidth) .....	5-28
Measurement of ACP (Adjacent Channel leakage Power) .....	5-32
Measurement of antenna power .....	5-36
Measurement of leakage power .....	5-37
Measurement of symbol rate .....	5-39

## Chapter 6 RECORD AND OUTPUT

1. Record to the Memory Card .....	6-2
Usable Memory Card .....	6-2
Memory Card Specifications .....	6-3
Contents of Storage to Memory Card .....	6-3
Note on Handling the Memory Card .....	6-4
Insertion and Ejection of Memory Card .....	6-5
How to Initialize the Memory Card .....	6-6
How to Store into the Memory Card (Save Function) .....	6-7
How to Call from the Memory Card (Recall Function) .....	6-9
Back Up of the Memory Card .....	6-10
2. How to Output to the Printer .....	6-12
Connectable Printer .....	6-12
Specification of the Output Form .....	6-13
Output to the Printer .....	6-16
3. Output for Plotter .....	6-17
Available plotter .....	6-17
Setup for the plotter .....	6-17
Setup for the plot format .....	6-18
Output to the plotter .....	6-19
Cancel for the plot output .....	6-19
4. Output to the File .....	6-21
Specifying the data output .....	6-21
Output to the file .....	6-22
Cancel for the file output .....	6-23
File size .....	6-23

5. Setup for the Target Device of the Screen	
Data Output .....	6-24
Setup of the target device .....	6-24

## Chapter 7 FUNCTION DESCRIPTIONS

1. Functions of Fundamental Keys .....	7-2
Center Frequency .....	7-2
Frequency Span .....	7-5
Reference Level .....	7-7
Resolution Bandwidth (RBW) .....	7-10
Video Bandwidth (VBW) .....	7-11
Selecting AUTO of Coupled Functions ...	7-12
Input Attenuator (ATT) .....	7-13
Input Key .....	7-14
Correction Factor Function .....	7-15
2. Functions of FORMAT Mode .....	7-17
Functions of TRACE mode .....	7-18
Explanation of Detector Mode Menu .....	7-25
Explanation of Limit Line Menu .....	7-26
Label Function .....	7-28
3. Functions of MARKER Section .....	7-29
Marker ON .....	7-29
Signal Track Mode .....	7-30
Peak Search .....	7-30
Multi-marker mode .....	7-35
Marker → (Marker to) .....	7-37
Other marker functions .....	7-39
Marker OFF .....	7-41
4. Functions of SWEEP Mode .....	7-42
Sweep Key .....	7-42
Explanation of Gated Sweep Function ...	7-43
Explanation of START Lamp (LED) .....	7-46
Sweep Time .....	7-47
Sweep Mode Switching .....	7-48
5. Functions of MEASUREMENT Section .....	7-49
Explanation of OBW (Occupied Bandwidth) Key .....	7-49
Explanation of ACP (Adjacent Channels Leakage Power) Key .....	7-52
HARMONICS (higher harmonics) measuring function .....	7-55

	Function of CW key .....	7-56
	Function of TRANSIENT key .....	7-62
	Explanation of communication system setup .....	7-81
6.	Save Function .....	7-85
	Save function menu .....	7-85
7.	Recall Function .....	7-93
	Recall function menu .....	7-93
8.	Calibration Function .....	7-96
	Recall function menu .....	7-96
9.	System Functions .....	7-99
10.	Window Function .....	7-101

## Chapter 8 GPIB REMOTE PROGRAMMING

1.	Introduction .....	8-2
	GPIB .....	8-2
	GPIB Setup .....	8-3
2.	GPIB BUS Functions .....	8-5
	GPIB Interface Functions .....	8-5
	Controller Functions .....	8-6
	Responses to Interface Messages .....	8-7
	Message Exchange Protocol .....	8-9
3.	Command Syntax .....	8-10
	Command Syntax .....	8-10
	Data Formats .....	8-11
4.	Status Bytes .....	8-13
	Status Register .....	8-13
	Event Enable Register .....	8-16
	Standard Operation Status Register .....	8-17
	Status Byte Register .....	8-18
	Standard Event Register .....	8-20
5.	List of GPIB Command Codes .....	8-21
	GPIB code of TRANSIENT mode .....	8-39
6.	Sample programs .....	8-44
	Data output format (talker) .....	8-48
	I/O of trace data .....	8-54
7.	RS-232 Remote Control Function .....	8-70
	Compatibility of GPIB remote control and RS-232C remote .....	8-70
	Setup for the measurement conditions ...	8-70
	Activation of the remote control .....	8-71

Parameter setup window .....	8-72
Interface connection .....	8-73
Data format .....	8-74
Different points between RS-232C and GPIB .....	8-75
Panel control .....	8-75
Example of the remote control .....	8-76
Error message .....	8-77
Change for other options .....	8-79
8. Batch measurement Command for the TRANSIENT mode of the Transmission System .....	8-80

**Chapter 9 IN ABNORMALITIES**

1. Inspection and Simple Troubleshooting .....	9-2
--	-----

**Chapter 10 OPERATION DESCRIPTION**

1. Description of Operations .....	10-2
Mixer Section .....	10-2
IF Section .....	10-3
LOG A/D Section .....	10-3
2. Block Diagram .....	10-4

**Chapter 11 SPECIFICATIONS**

1. R3463/3465 Specifications .....	11-2
Measurement Function .....	11-2
Frequency Characteristics .....	11-2
Amplitude Range .....	11-3
Dynamic Range .....	11-3
Amplitude Accuracy .....	11-5
Time Domain measurement .....	11-6
Analog Demodulation .....	11-6
Digital modulation analysis .....	11-6
Input/Output .....	11-7
General Specifications .....	11-9
Options .....	11-9



**APPENDIX**

- 1. Glossary ..... A-2
- 2. dB Conversion Formulas ..... A-7
- 3. Menu Lists ..... A-8
- 4. Restriction on the IC Card ..... A-21
  - Usable Cards ..... A-21
  - Nonusable Cards ..... A-21
- 5. List of Messages ..... A-22

**DIMENSIONAL OUTLINE DRAWING .....EXT-1**

**ALPHABETICAL INDEX ..... I-1**



## LIST OF ILLUSTRATIONS

No.	Title	Page
1-1	Operating Conditions .....	1-3
1-2	Environmental Conditions .....	1-4
3-1	Connecting the Power Cable .....	3-2
3-2	Power Switch .....	3-3
3-3	Panel keys and soft keys .....	3-5
3-4	Displayed active area .....	3-7
3-5	How to set data .....	3-7
3-6	Annotation on the Screen .....	3-9
3-7	Connection for calibration .....	3-10
3-8	Connection for power level measurement .....	3-11
3-9	Power level measurement for 30 MHz CAL signal .....	3-12
3-10	Reference level setting .....	3-13
3-11	Power level measurement by increased display resolution .....	3-14
3-12	Connection for frequency measurement .....	3-15
3-13	Frequency measurement for 30 MHz CAL signal .....	3-16
3-14	Measurement by frequency counter .....	3-17
3-15	Display of maximum level at marker point .....	3-18
3-16	Frequency measurement in COUNTER mode .....	3-19
3-17	MKR⇒CF function .....	3-20
3-18	MKR⇒REF function .....	3-21
3-19	Dynamic range and sweep rate .....	3-22
5-1	Frequency measurement with normal marker .....	5-2
5-2	Frequency measurement in frequency counter mode ..	5-3
5-3	Measurement of AM signal .....	5-5
5-4	Adjusting the signal level .....	5-6
5-5	Measuring the period of modulated wave .....	5-8
5-6	Modulation frequency of AM wave .....	5-9
5-7	Modulation index of AM wave .....	5-9
5-8	Setting of center frequency .....	5-10
5-9	AM wave of high modulation frequency and low modulation index .....	5-11
5-10	Relation between sideband level-carrier level ( $E_{SB} - E_C$ ) and modulation index $m(\%)$ .....	5-12

No.	Title	Page
5-11	Measurement of FM wave . . . . .	5-13
5-12	Adjustment of signal level . . . . .	5-14
5-13	Moving the marker on the peak of modulated wave . . . . .	5-15
5-14	FM wave of low modulation frequency . . . . .	5-16
5-15	Adjusting carrier frequency at center frequency . . . . .	5-17
5-16	Carrier peaks . . . . .	5-18
5-17	FM wave of high modulation frequency and low m value . . . . .	5-18
5-18	Adjusting central frequency at the carrier frequency . . . . .	5-19
5-19	FM wave with small $\Delta f_{peak}$ . . . . .	5-20
5-20	FM wave with large $\Delta f_{peak}$ . . . . .	5-21
5-21	$f_C$ and $E_C$ of FM wave . . . . .	5-22
5-22	$f_{SB}$ and $E_{SB}$ of FM wave . . . . .	5-23
5-23	Pulse modulated wave . . . . .	5-24
5-24	OBW measurement screen . . . . .	5-29
5-25	OBW measurement menu . . . . .	5-30
5-26	OBW measurement screen . . . . .	5-31
5-27	ACP measurement screen . . . . .	5-33
5-28	ACP measurement menu . . . . .	5-34
5-29	ACP measurement screen . . . . .	5-35
5-30	Antenna power measurement screen . . . . .	5-36
5-31	Leakage power measurement menu . . . . .	5-37
5-32	Leakage power measurement screen . . . . .	5-38
5-33	Symbol rate measurement screen . . . . .	5-39
6-1	Drive Slot for Memory Card . . . . .	6-5
6-2	The Menu Screen of Save Function . . . . .	6-7
6-3	The Menu Screen of the Recall Function . . . . .	6-9
6-4	Printing Example in the Printing Mode "Gray" . . . . .	6-14
6-5	Printing Example in the Printing Mode "Mono S" . . . . .	6-14
6-6	Printing Example in the Printing Mode "Mono L" . . . . .	6-15
6-7	Printing Example in the Menu Print "OFF" . . . . .	6-15
7-1	Functions of Fundamental Keys on the Front Panel . . . . .	7-2
7-2	Center Frequency Display . . . . .	7-2
7-3	Start/Stop Frequency . . . . .	7-3
7-4	Frequency Span . . . . .	7-5
7-5	Reference Level . . . . .	7-7

No.	Title	Page
7-6	RBW : Maximum IF Bandwidth which can separate two signals	7-10
7-7	VBW = 300 kHz	7-11
7-8	VBW = 3 kHz	7-11
7-9	FORMAT Key on the Front Panel	7-17
7-10	Write Mode and View Mode	7-19
7-11	No Averaging	7-20
7-12	After Averaging 20 Times	7-20
7-13	Label Input Screen	7-28
7-14	MARKER Section Key on the Front Panel	7-29
7-15	Next Peak Search Execution	7-32
7-16	$\Delta Y$ Setting	7-33
7-17	In the Case of Up Setting	7-34
7-18	In the Case of Low Setting	7-34
7-19	MARKER Section Key on the Front Panel	7-42
7-20	Trigger is made at the waveform being displayed	7-46
7-21	SWP = AUTO (500 ms)	7-47
7-22	SWP = 50 ms	7-47
7-23	Panel Keys in MEASUREMENT Section	7-49
7-24	Time domain wave form measurement screen	7-63
7-25	Time domain wave form measurement screen (dual screen)	7-67
7-26	OBW measurement screen	7-71
7-27	ACP measurement screen	7-72
7-28	Spurious measurement screen	7-73
7-29	IN-Band spurious screen	7-76
7-30	Antenna power measurement screen	7-77
7-31	Leakage power measurement screen at Carrier OFF	7-78
7-32	Modulation accuracy measurement screen	7-79
7-33	Transmission velocity measurement screen	7-80
7-34	Communication type setup menu	7-81
7-35	Displayed drive list	7-85
7-36	Displayed drive list	7-86
7-37	Displayed drive list	7-89
7-38	Displayed drive list	7-93
7-39	Setting the date and time	7-99

No.	Title	Page
8-1	Relation between screen grid and trace data . . . . .	8-54
8-2	Selected window of serial port (OPT08 and OPT15 are already installed) . . . . .	8-71
8-3	Parameter setup . . . . .	8-72
8-4	Connection of the controller and Spectrum Analyzer . . . . .	8-73
8-5	Cable wiring diagram . . . . .	8-73
8-6	Data format . . . . .	8-74
10-1	Block Diagram of R3463 . . . . .	10-4
10-2	Block Diagram of R3465 . . . . .	10-5
A-1	Bandwidth Switching Accuracy . . . . .	A-2
A-2	IF Bandwidth . . . . .	A-3
A-3	Noise Sideband . . . . .	A-3
A-4	Occupied Bandwidth . . . . .	A-4
A-5	Reference Level . . . . .	A-4
A-6	Bandwidth Selectivity . . . . .	A-5
A-7	Spurious Response . . . . .	A-5
A-8	VSWR . . . . .	A-6

## LIST OF TABLES

No.	Title	Page
1-2	Power Supply Specifications .....	1-5
4-1	Warm-up time for built-in reference crystal oscillator ...	4-2
6-1	Memory Card Specifications .....	6-3
6-2	Recommended Printer .....	6-12
6-3	Printer Output Format .....	6-13
6-4	Operation tested plotters by ADVANTEST .....	6-17
6-5	Plotter paper size .....	6-20
6-6	Assignment of the plotter pen .....	6-20
6-7	File extension .....	6-22
6-8	Output File Size .....	6-23
7-1	Display Resolution of Center Frequency .....	7-3
7-2	Display Resolution of Frequency Span .....	7-5
7-3	Standard values .....	7-70
8-1	Trace accuracy designation code .....	8-54







## INTRODUCTION

This chapter gives a brief explanation of product, its working environment and operational precautions. Read this chapter before you use the product.

---

### CONTENTS

---

1. Outline of Product .....	1-2
2. Operating Conditions .....	1-3
3. Power Source .....	1-5
4. Cleaning, Storage, and Transportation ...	1-9
5. Notes on Use .....	1-10

---

# 1. Outline of Product

R3463/3465 is a modulation spectrum analyzer which can analyze digital modulation such as measurement of modulation accuracy, transmission velocity, etc. in addition to conventional spectrum analyzing.

- The measurement frequency range is between 9 kHz to 8 GHz for R3465 (9 kHz to 3 GHz for R3463) which covers digital radio frequency ranges.
- The span accuracy of under  $\pm 1\%$  ( $\text{span} \leq 5\text{MHz}$ ) is realized by introducing DDS (Direct Digital Synthesizer) system.  
Measurement frequency range : R3463 ; 9 kHz to 3 GHz  
R3465 ; 9 kHz to 8 GHz  
Frequency stability : Residual FM; under 3 Hz P-P /0.1S  
Drift; < 20Hz  
Frequency span accuracy : <  $\pm 1\%$  ( $\text{span} \leq 5\text{ MHz}$ )  
Resolution bandwidth : 5 MHz maximum
- TRANSIENT mode is equipped which measures modulation accuracy of digital modulation signal/burst signal, OBW, ACP, etc. at high speed.
- Parameter for standard measurements corresponding to various communication types (PHS/PDC/NADC) can be set automatically.
- According to installing an optional function, parameters for standard measurements corresponding to GSM, DCS1800 and DCS1900 communication types can be set automatically. (Only R3465)
- Functions that are in frequent use such as occupied bandwidth (OBW), adjacent channel leakage power (ACP), harmonic distortion measurement (HARM), etc. are put at independent keys to improve the operational performance.
- Easy of display viewing are improved by introducing 6.5 inch TFT color liquid crystal display. It's also easy to carry with a mass of only 17 kg.

## 2. Operating Conditions

### ■ Operating environmental conditions

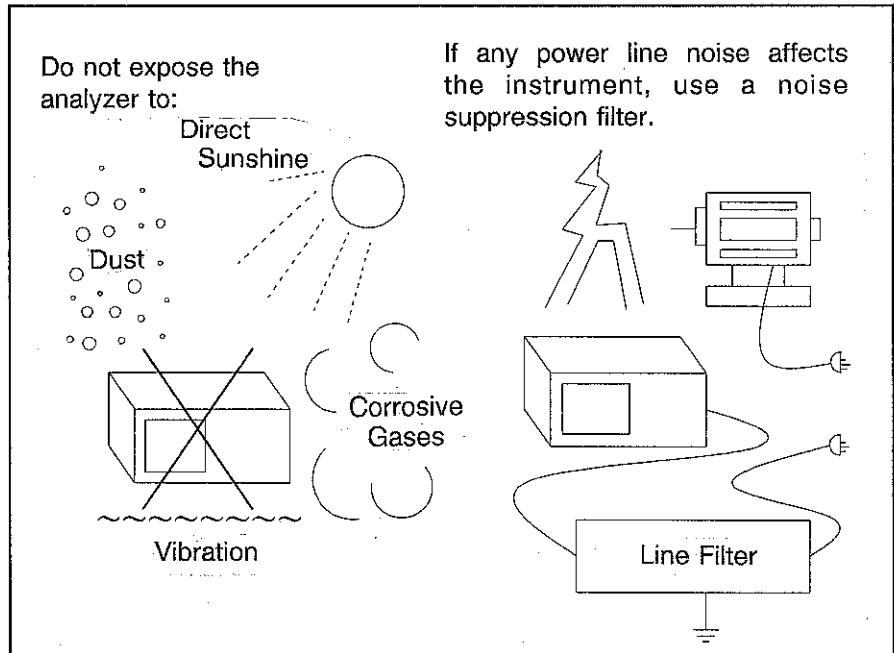

Figure 1-1 Operating Conditions

- Environmental temperature:
  - 0 °C to +50 °C (Operating temperature range)
  - 20°C to +60°C (Storage temperature range)
- Relative humidity: RH85% or less (Non- condensing)
- Place without corrosive gases
- Place without exposed to direct sunshine
- Place without dust
- Place without vibration
- Place where there is minimum noise

The instrument is designed to resist noise from AC power lines. However, you should still take steps to minimize power line noise. If necessary, install a noise suppression filter.

For highly accurate measurement, turn the power ON after the instrument temperature has reached the room temperature level, and warm up the instrument for 60 minutes.

## ■ Installation

Air cooling fan of the exhaust type is built into the rear panel. Do not close this outlet.

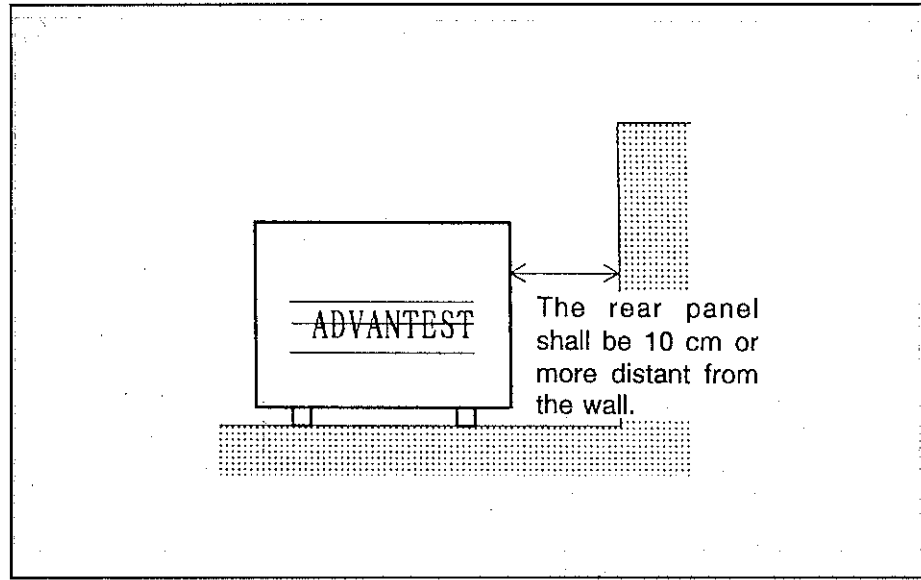

Figure 1-2 Environmental Conditions

### 3. Power Source

#### ■ Checking Power Requirements

**WARNING !**

*Safely use R3463/3465 according to the power requirement. R3463/3465 might be damaged to the case not following the power requirement.*

The power requirement of R3463/3465 is shown in the following.

**Table 1-2 Power Supply Specifications**

	100V <sub>AC</sub> operation	220V <sub>AC</sub> operation
Input voltage range	90 V to 132 V	198 V to 250 V
Frequency range	48 Hz to 66 Hz	48 Hz to 66 Hz
Power Fuse	T6.3A/250V	
Power consumption	300VA or below	

#### ■ Changing the supply voltage

The supply voltage of this instrument is automatically changed over (100/240 V). Be sure to use a power cable which matches the supply voltage and conforms to the related standard.

## ■ Replacing the power fuse

### **WARNING !**

1. Before replacing the power fuse, be sure to turn the power switch OFF and remove the power cable from the outlet.
2. For continued protection against fire hazard, use a fuse of the type and rating which match the supply voltage.

Power fuse is accommodated in the FUSE holder on the rear panel. To check or replace the power fuse, observe the following procedure.

- 1 With a flat blade, turn counterclockwise the cap of the FUSE holder by approximately 90 degree.

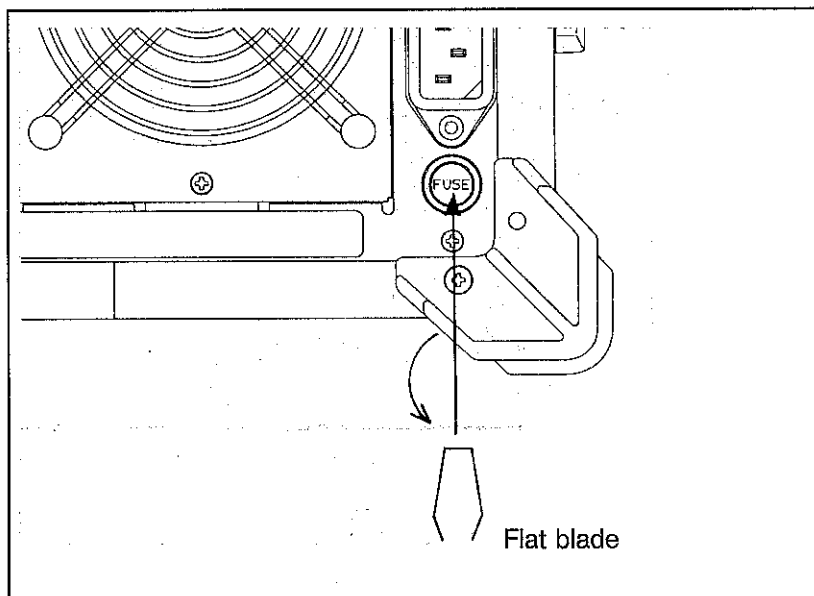

Take the flat blade off the cap, and the FUSE holder comes out by approximately 3 mm.

- 2 Pull the FUSE holder out, and replace the fuse with new one.

Use a fuse which conforms to the following specification:

Input voltage range	Fuse
AC 90 to 132 V	T6.3 A/250 V
AC 198 to 250 V	T6.3 A/250 V



**3**

After replacing the fuse, re-insert the FUSE holder, slightly push it by a flat blade and turn it clockwise by approximately 90 degree to put it in position.

## ■ Connecting the Power Cable

### **WARNING !**

#### 1. Power cable

- Use power cable of the attachment for the electric shock and the fire prevention.
- Use power cable in accordance with the safety standard of the country for use excluding Japan.
- When you connect power cable with the outlet, turn off the power switch.
- When you pull out power cable from the outlet, have the plug.

#### 2. Protective earth

- Connect the power plug cable with the power outlet which has the protective earth terminal.
- If the code for the extension without the protective earth terminal is used, the protective earth will become invalid.
- Case in which use of AC adapter (Three pins to two pins conversion adapter), the earth pin of the adapter is grounded to the earth of the outlet, or connect ground terminal of the rear panel with the earth of the outside, and ground it to the earth.

- (1) A three-pin power connector is insufficient for Japan, so a 3-pin-to-2-pin adapter is provided. It is extremely important when using this adapter for connection to a power outlet to ground the ground pin extending from the adapter.

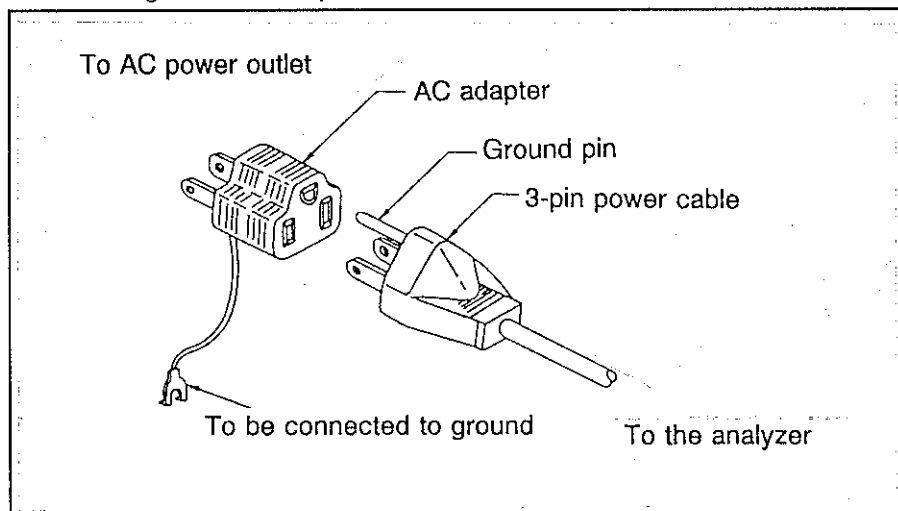

- (2) AC power cable for overseas use.

Information of AC power cable for overseas use is shown on page Plug-1\*.

Refer to page Plug-1\*.



## 4. Cleaning, Storage, and Transportation

### ■ Cleaning

Wipe any dirt of R3463/3465 off with a soft cloth (or damp cloth). Attend to the following points.

- Do not remain the fluff of the cloth and do not soak water into the internal of R3463/3465.
- Do not use an organic solvent (for example, benzene and acetone, etc.) which changes plastics in quality.

### ■ Storage

Storage temperature of this instrument is from -20 to +60 degrees C. Do not store it out of this temperature range.

In case that R3463/3465 is not used for a long time, cover with the vinyl cover or put in the cardboard box and prevent dust. Keep it in a dry place where dust and direct sunshine were prevented.

### ■ Transportation

When you transport R3463/3465, pack it to the first packing material.

#### Packing procedure

- 1** Wrap R3463/3465 itself with cushion material and put in the cardboard box.
- 2** After putting attachment, put cushion again.
- 3** Shut the lid of the cardboard box. Fix the outside with string or tape.

#### ● To carry the instrument by hand

To carry the instrument by hand, put it in a transit case. The transit case is prepared as optional accessory.

## 5. Notes on Use

### ■ Case that abnormality occurs

When smoke rises from R3463/3465, turn off the power switch. Pull out from the outlet. And contact to our company.

The address and the telephone number of our company are in the end of this manual.

### ■ Warm up

After the instrument temperature has reached the room temperature level, turn the power switch ON and warm it up for 60 minutes.

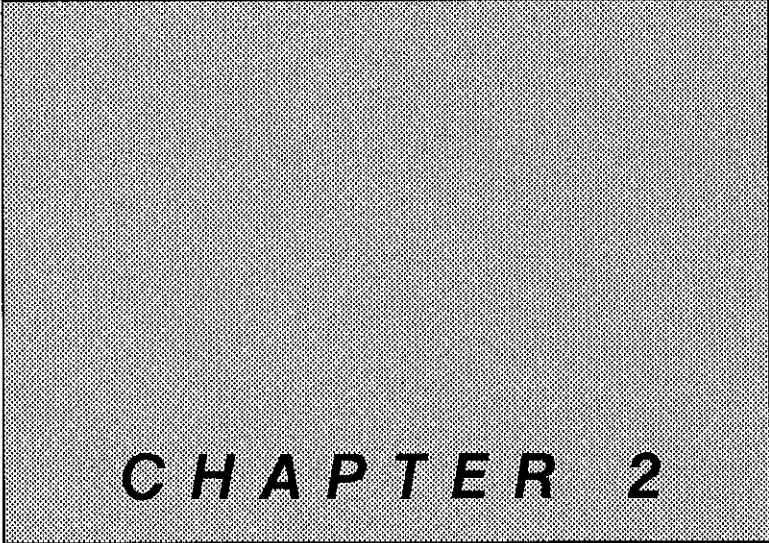

**DESCRIPTION OF FRONT AND REAR  
PANELS**

This chapter briefly explains each section on the front and rear panels.

---

**CONTENTS**

---

- 1. Description of the Front Panel ..... 2-2
  - 2. Description of the Rear Panel ..... 2-7
-

# 1. Description of the Front Panel

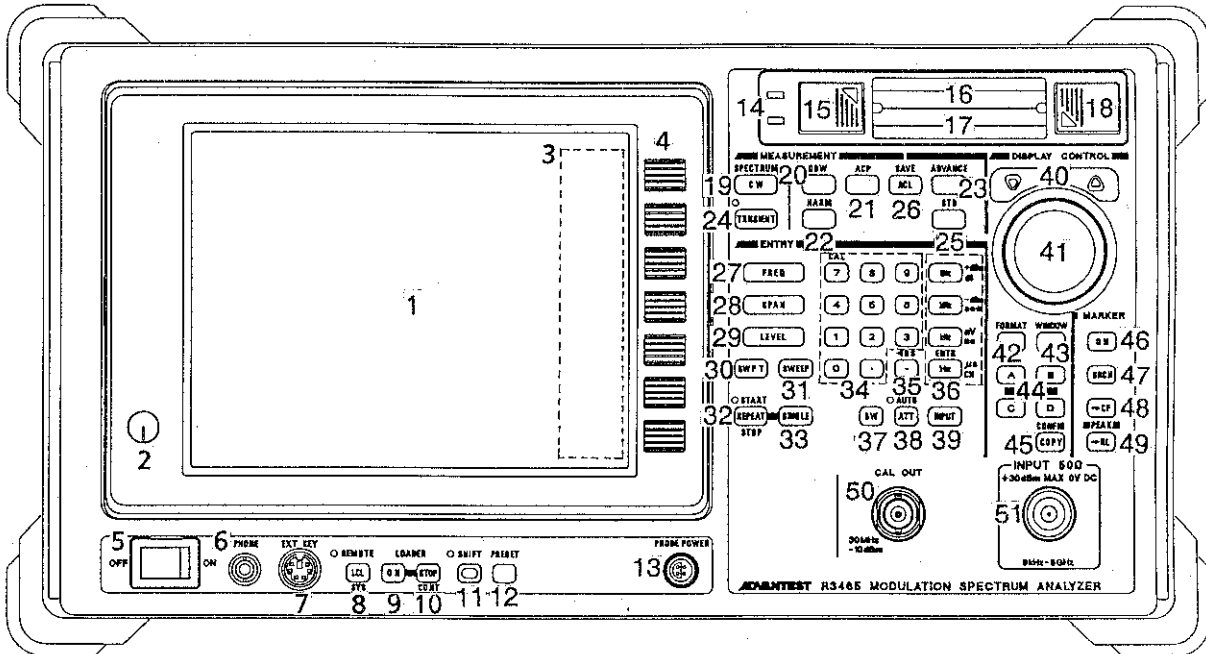

- 1 Liquid crystal display (LCD) : Displays waveform and measured data by color. The whole display can be tilted.

**CAUTION !**

*When this instrument is used in long hours at high temperature, a blurred section may arise on the LCD display. This problem comes from not a failure of the LCD display.*

*If this problem arises, turn off the power and turn on that.*

*The problem is solved.*

- 2 INTENSITY control : Used to adjust the intensity of display (adjustable in the range from approximately 70% to maximum intensity).
- 3 Soft menu display section : Maximum 7 items can be displayed.
- 4 Soft-key : 7 soft-keys are prepared, which correspond to the software menu display on the left.
- 5 Power switch : To turn the power ON/OFF.
- 6 PHONE connector : 8-ohm earphone terminal to output AM or FM demodulated voice.

- 7 EXT KEY connector : Used to connect to an external keyboard (option 15).
- 8 LCL key : Used to cancel external control (while the REMOTE lamp is lighting).
- SYS key : Used to set system functions (in LOCAL mode).
- REMOTE lamp : Lights up in REMOTE mode.
- 9 CNTRLR key : Used to enter a control function (option 15).
- 10 CNTRLR STOP key : Used to start/stop a control function (option 15).
- 11 SHIFT key : Used to select SHIFT mode (expanded function). When selected, the LED lights up.
- 12 PRESET key : Used to initialize the panel setting.
- 13 PROBE POWER : Power supply for accessories, such as active probe.

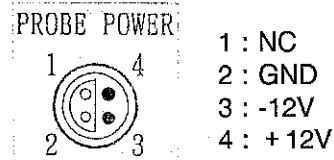

- 14 Drive A/B lamp : Lights up while a memory card is being used.
- 15 Eject button for drive B : Eject button for the memory card which is set in drive B. When pressed, the memory card can be taken out of drive B.
- 16 Memory card inserting slot for drive B
- 17 Memory card inserting slot for drive A
- 18 Eject button for drive A : Eject button for the memory card which is set in drive A. When pressed, the memory card can be taken out of drive A.

## MEASUREMENT Section

- 19 CW key : Used to analyze spectrum of continuous waveform.
- 20 OBW key : Used to measure occupied bandwidth.
- 21 ACP key : Used to measure leak power from adjacent channel.
- 22 HARM key : Used to measure harmonic distortion.
- 23 ADVANCE key : Used to test the transmitter or automatically execute basic measurement (option 15).
- 24 TRNSIENT key : Analyzes burst signal.
- 25 STD key : Sets the standard of transmitter test.
- 26 RCL key : Used to call the set conditions and waveform which are stored in the backup memory or a memory card.
- SAVE key : Used to save the currently set conditions or waveform.  
(SHIFT + RCL)

## ENTRY Section

- 27 FREQ key : Used to select Center Frequency Input mode.
- 28 SPAN key : Used to select Frequency Span Input mode.
- 29 LEVEL key : Used to select Reference Level Input mode.
- 30 SWP T key : Used to set sweep time.
- 31 SWEEP key : Used to set sweep mode and trigger.
- 32 REPEAT key : Used to execute continuously automatic measurement or sweep.
- 33 SINGLE key : Used to execute automatic measurement with one sweep only.
- 34 Ten-key (expanded function keys) : Includes numeric keys (0 to 9) and a decimal point key. Can perform expanded functions when pressed together with SHIFT key.
- CAL key (SHIFT + 7) : Used to calibrate the instrument.

- 35 B.S key : Used to correct the data input with ten-key or to input minus (-) sign.
- 36 Unit key : Used to select or set unit.
- GHz key : Used to input data by GHz, dBm or dB.
- MHz key : Used to input data by MHz, -dBm or sec.
- kHz key : Used to input data by kHz, mV or msec.
- Hz key : Used to input data by Hz or  $\mu$ s, for channel designation, or as ENTER key.
- 37 BW key : Used to set RBW and VBW.
- 38 ATT key : Used to set the input attenuator.
- 39 INPUT key : Used to set transducer factors.

## DISPLAY CONTROL Section

- 40 Step key : Used to input data by step.
- 41 Data knob : Used for fine adjustment of data input.  
Pressing it on STD display screen in TRANSIENT mode, it can be used as each item's ENTER key.
- 42 FORMAT key : Used to set trace mode, display line and limit line or to input label.
- 43 WINDOW key : Used to set measuring window or multi-window.
- 44 SCREEN key : Used to select the active display on split screen.
- 45 COPY key : Used to output wave form to a printer, plotter and the file.
- CONFIG key  
(SHIFT + COPY) : Used to set the conditions for a printer, plotter and the file output.

1. Description of the Front Panel

**MARKER Section**

- 46 ON key : Used to display a marker.
- 47 SRCH key : Used to search the peak point.
- 48 ⇒CF key : Used to set frequency to the center frequency of the maximum level of displayed waveform.
- 49 ⇒RL key : Used to set reference level to the maximum level of the waveform displayed.
- 50 CAL OUT connector : Outputs level calibration signal, which is used for automatic calibration.
- 51 INPUT connector : 50-ohm N-type input connector. Can analyze the signal of maximum input level +30 dBm, 0 VDCmax in the frequency range from 9 kHz to 3 GHz for R3463 (9 kHz to 8 GHz for R3465).



## 2. Description of the Rear Panel

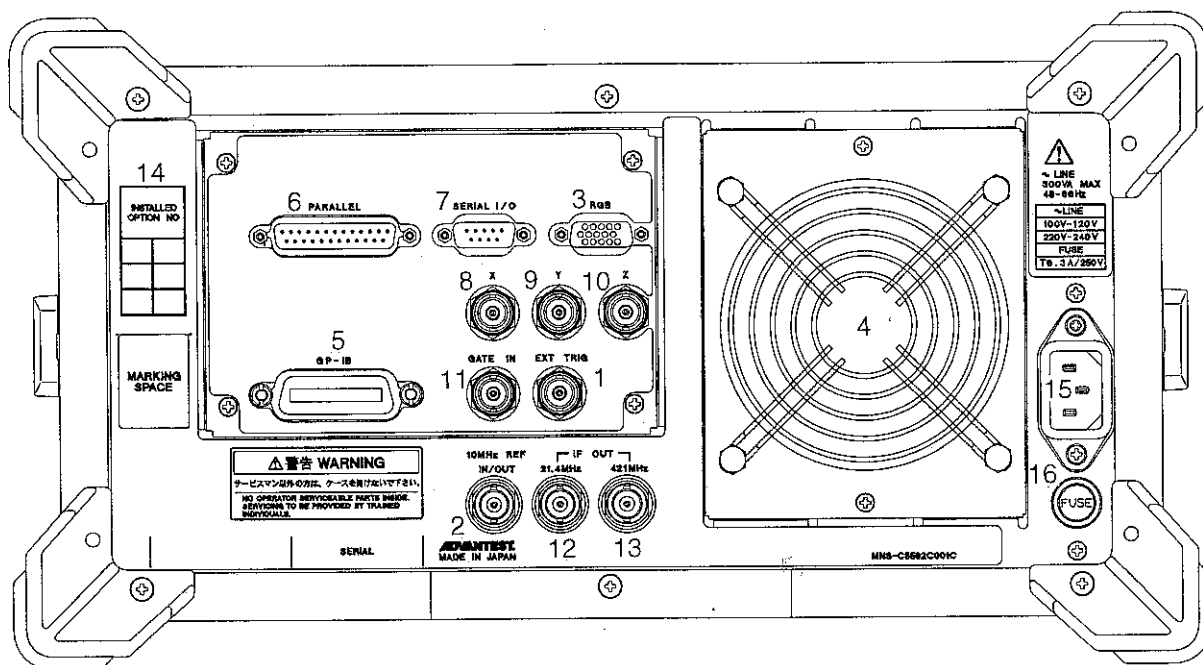

- 1 External trigger input terminal
  - : Approximately 10k ohm input impedance. Starts sweeping at the leading/trailing edge (selectable) of TTL level input signal. This can be used for the gate signal input for gated sweep.
- 2 10 MHz reference frequency signal I/O terminal
  - : I/O terminal for 10 MHz reference frequency signal
  - Input impedance : Approx. 50 ohm
  - Input level : -5 to +5 dBm
  - Output level : Approx. 0 dBm
- 3 Video output terminal : RGB signal output equivalent to VGA (640 x 480)
- 4 Cooling fan : Exhaust cooling fan.
- 5 GPIB connector : Connector for GPIB cable from external controller or plotter.
- 6 PIO connector : Connector for Centronics printer.
- 7 RS-232 connector : Connector for external controller which is used to execute remote control via RS-232 interface.

2. Description of the Rear Panel

---

- 8 X output terminal : Outputs approx. -5 to +5 V ramp voltage proportional to sweep.  
Output impedance : Approx. 1k ohm
- 9 Y output terminal : Outputs video signal with detection in proportion to CRT trace vertical deflection.  
Output voltage : approx. 0 to 2 V (10dB / DIV)  
approx. -3 to 5 V  
Output impedance : approx. 220 ohm
- 10 Z output terminal : Outputs +5 V (TTL High level) when the spectrum analyzer is executing sweep, while 0 V (TTL Low level) when blanking.
- 11 Gate sweep control terminal : Stops sweep and measurement when TTL Lo level, and executes sweep and measurement when TTL Hi level.
- 12 21.4 MHz IF OUT : Outputs final IF (21.4 MHz) signal.  
Bandwidth : Set resolution bandwidth  
Output level : Approx. -15 dBm for the full scale on CRT  
Output impedance : approx. 50 ohm
- 13 421.4 MHz IF OUT : Outputs 2nd IF (421.4 MHz) signal.  
Output impedance : approx. 50 ohm
- 14 Indication for built-in option devices
- 15 AC power connector : 3-pin connector. Center pin is for grounding.
- 16 FUSE holder : Accommodates a power line fuse.

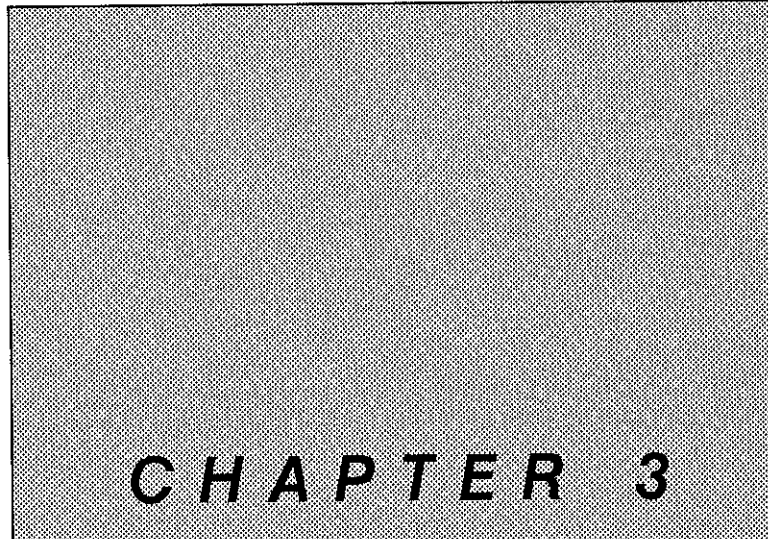

**CHAPTER 3**

**FUNDAMENTAL OPERATION**

This chapter explains the fundamental operation for those who use this instrument for the first time.

---

**CONTENTS**

---

1. Initial power-on .....	3-2
2. Operation keys .....	3-5
3. Annotation on the screen .....	3-9
4. Calibration .....	3-10
5. Measuring the power level .....	3-11
6. Measurement of Frequency .....	3-15
7. Dynamic Range and Sweep Rate .....	3-22
8. Switching Standard Measurement Function .....	3-24

---

# 1. Initial power-on

## ■ Connecting to AC power source

1

With the instrument's power switch turned OFF, connect the attached power cable to the AC power connector on the rear panel.

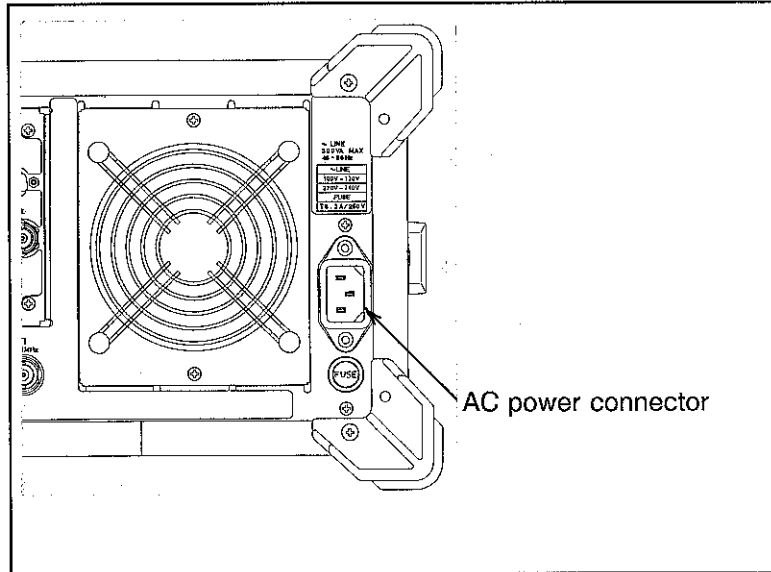

Figure 3-1 Connecting the Power Cable

2

Connect another end of the power cable to an outlet.

**WARNING !**

Connecting to an out-of-spec power source may damage this instrument. Power specification of this instrument is as follows:

	Operation under 100 V <sub>AC</sub>	Operation under 220 V <sub>AC</sub>
Input voltage	90 to 132 V	198 to 250 V
Frequency	48 to 66 Hz	48 to 66 Hz

## ■ Power-on

After connecting the power cable, turn ON the power switch on the front panel.

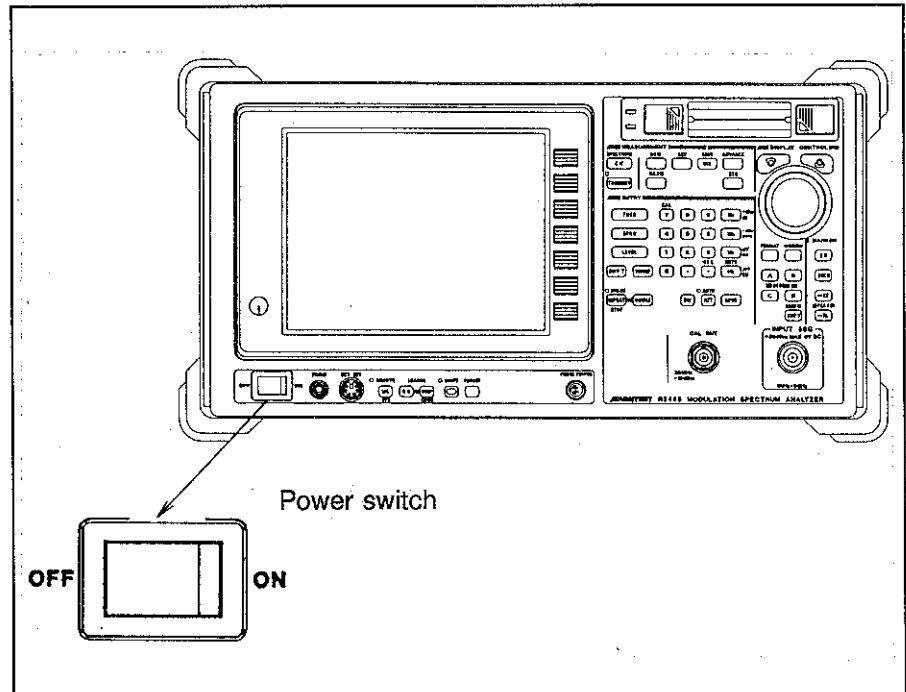
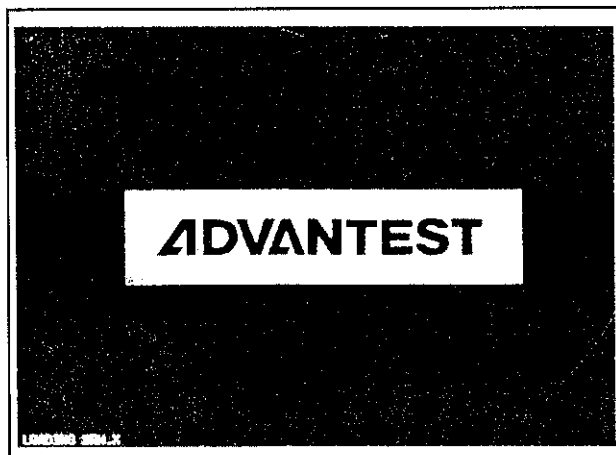

Figure 3-2 Power Switch

When the power switch is turned ON, the following screen appears on the LCD. A few seconds later, the screen changes to the initial setting screen.



"ADVANTEST" is displayed at the center of screen. (While this is displayed, self checking is executed.)

1. Initial power-on

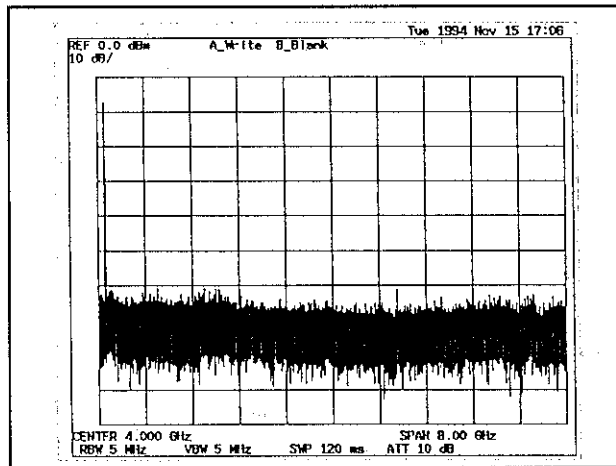

Initialization screen after shipment (R3465)

When the instrument is used for the first time after shipment, the screen shown on the above appears. In general, previously set conditions are backed up, and a waveform under such conditions is displayed when the power switch is turned ON.

To reset to the initial setting at shipment, press

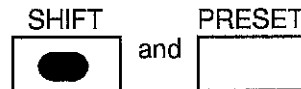

**CAUTION !**

*The contents of the PRESET can be changed by the function of the saving.*

*Default IP: The initial setting at shipment.*

*Save REG#IP: Saves the present set condition.*

## 2. Operation keys

### ■ Panel keys and soft keys

This instrument is operated with panel keys and soft keys.

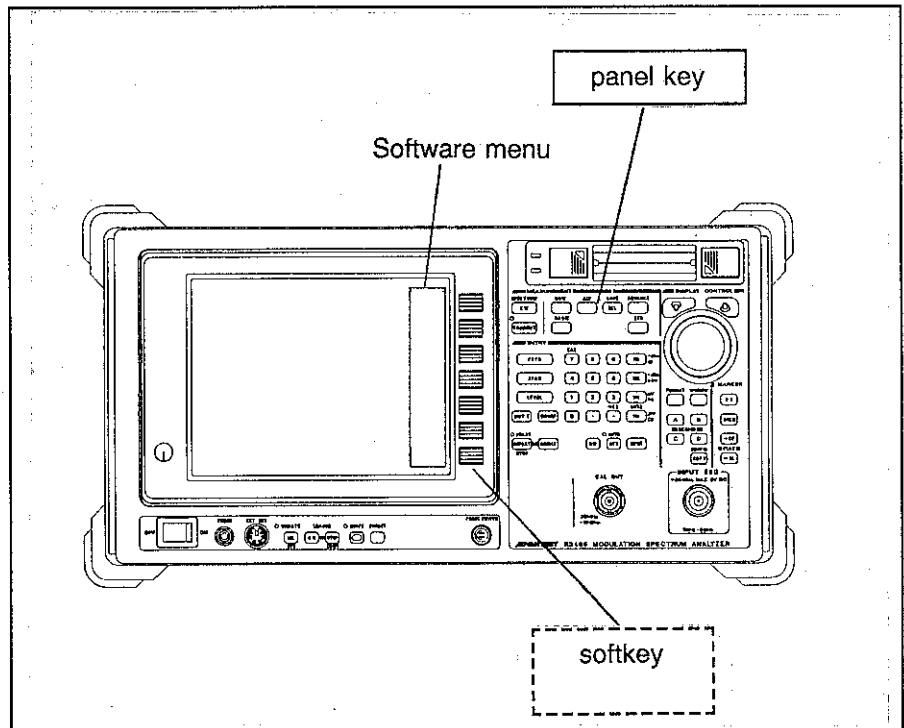

**Figure 3-3 Panel keys and soft keys**

Pressing a panel key displays a software menu at right on the screen.

Press a soft key, and the corresponding function in the software menu will be displayed.

2. Operation keys

Press **FREQ** panel key, which is used to set center frequency, and the following software menu appears at right in the display.

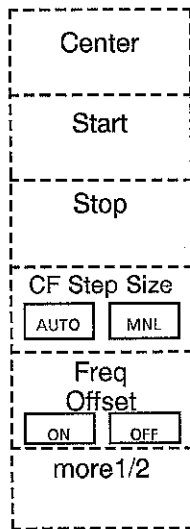

The software menu for **FREQ** includes six items as shown in the figure at left.

The remaining one item is currently not used and kept blank.

Furthermore, the key in the software menu appeared in the red frame ("Center" in FREQ at the initial condition) is shown in the active condition that the setting can be changed.

**NOTE**

*This menu **more1/2** is not provided to R3463.*

● **Function of SHIFT key**

To execute the functions marked in blue above the panel keys, press



key together with the corresponding key.

Pressing **SHIFT** key lights up the LED at upper left.

**Example:** To select calibration function.

Press **SHIFT** and **CAL 7** keys.



● **Data setting**

When a panel key and a soft key is pressed to set data, the function of the pressed key and the current set conditions are displayed at upper left on the screen. This display area is called "active area". Set data, checking the values displayed in the active area.

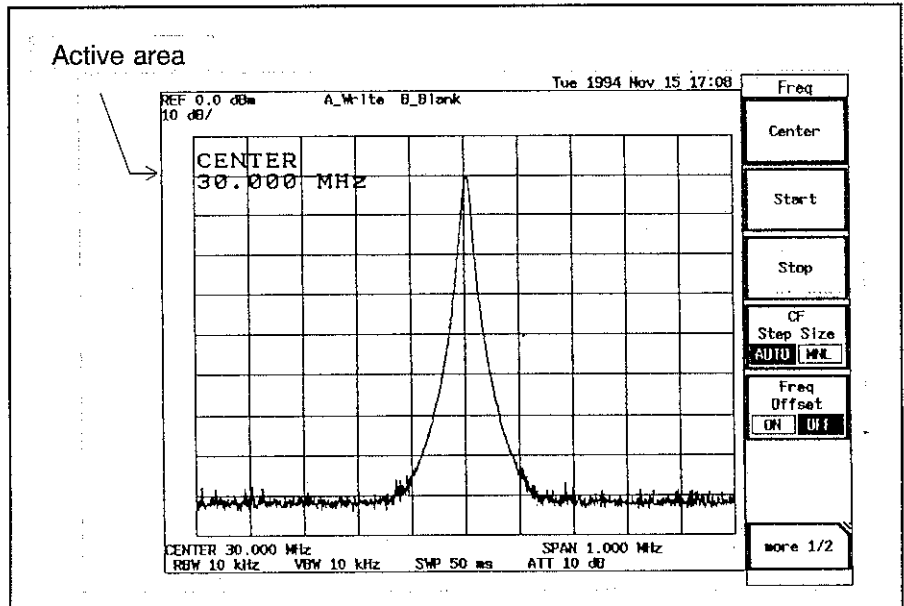

Figure 3-4 Displayed active area

There are 3 methods for setting data.

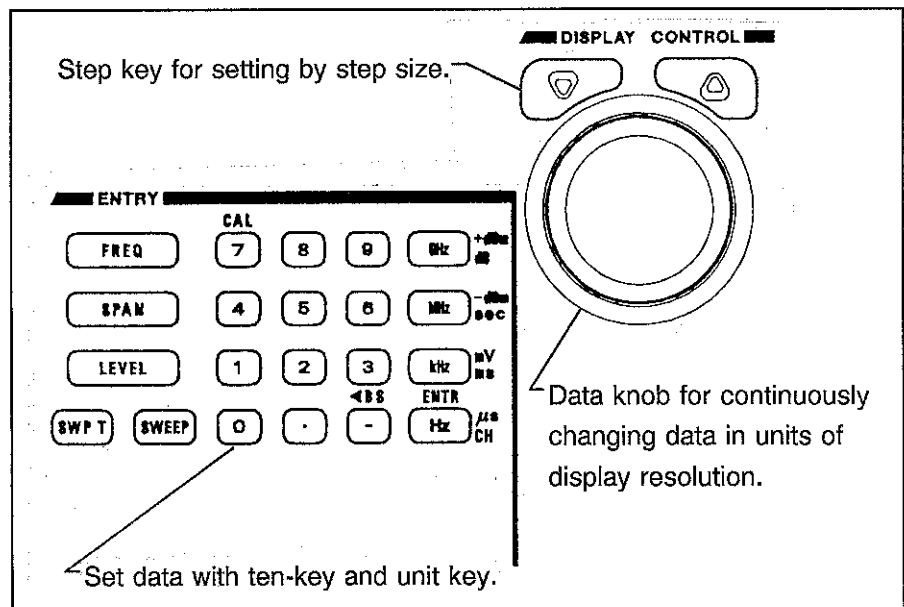

Figure 3-5 How to set data



2. Operation keys

○ **Ten-key and unit key**

These keys are used to input numeric data.



Input a numeric value with ten-key, and press a unit key.

To execute a function marked in blue above the numeric keys, use "SHIFT" key.

Pressing  key deletes the rightmost digit of the numeric value which has been input with ten-key. This key is useful for correcting input data. When no data is input, pressing  key inputs "-(minus)" sign.

○ **Step key and data knob**

Step key is used to set data by predefined step size.

Pressing  key decrements the data, while pressing  key increments the data.

Data knob is used to set data in units of predefined display resolution. It is very convenient for finely adjusting set data.

When pressed in label mode or setting data, it functions as ENTER key.

○ **Dialog Box (Setting Menu), Error/Warning Message**

The dialog box that is displayed to set the date or to select the printing output or the error/warning message that is not erased automatically after the specified time is cleared by pressing a panel key .

### 3. Annotation on the screen

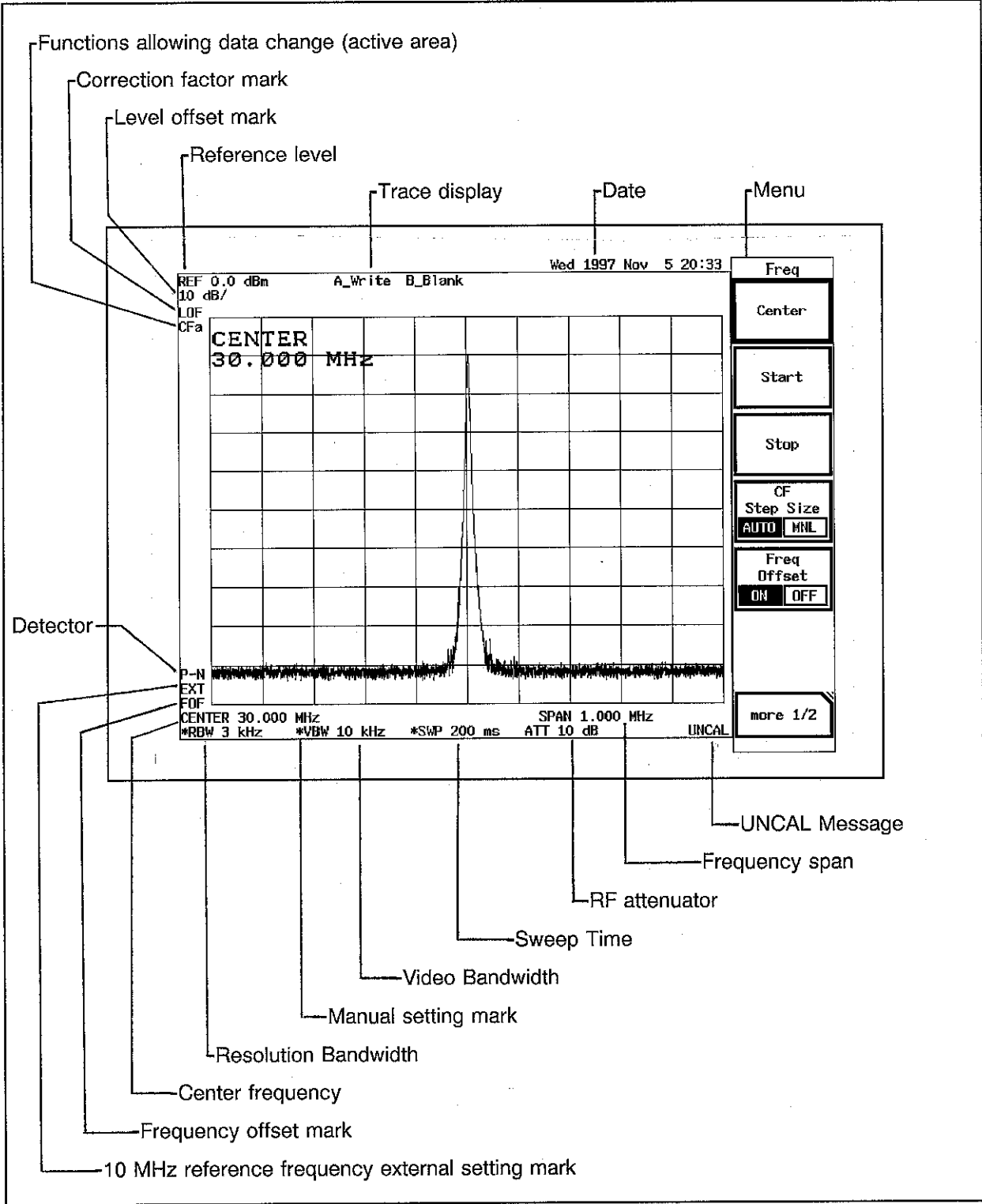

Figure 3-6 Annotation on the Screen

## 4. Calibration

To execute measurement at specified accuracy, warm up the instrument for more than 60 minutes after the power has been turned on.

- 1 Connect the N-BNC adapter to the INPUT connector on the front panel.
- 2 Connect CAL OUT and INPUT connectors on the front panel with the BNC cable (150mm).

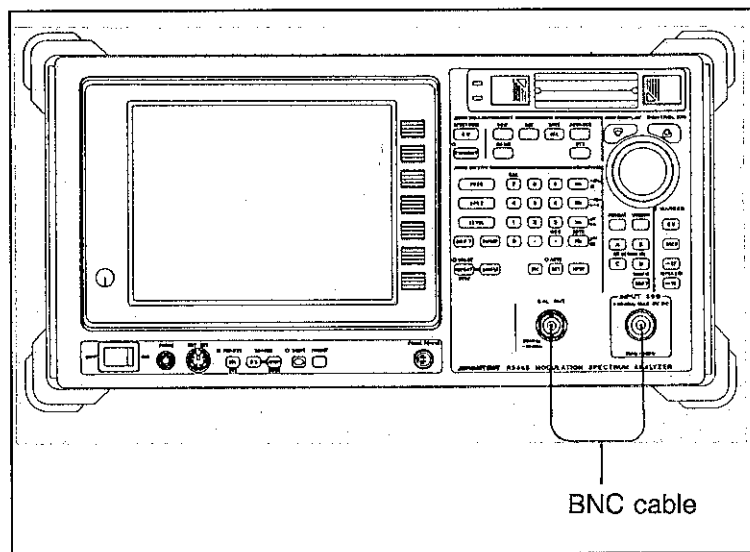

Figure 3-7 Connection for calibration

- 3 Press **SHIFT**, **CAL 7** and **CAL All** keys to execute calibration.

It takes approximately 8 minutes until calibration is completed.

### **CAUTION !**

*Sometimes, there is a noise of switching in the instrument on executing the calibration. This is the noise that switches the RF attenuator.*

## 5. Measuring the power level

1 Press **SHIFT** and **PRESET** keys to reset to initial setting.

2 Connect the N-BNC adapter to the INPUT connector on the front panel.

3 Connect CAL OUT and INPUT connectors on the front panel with the BNC cable (150mm).

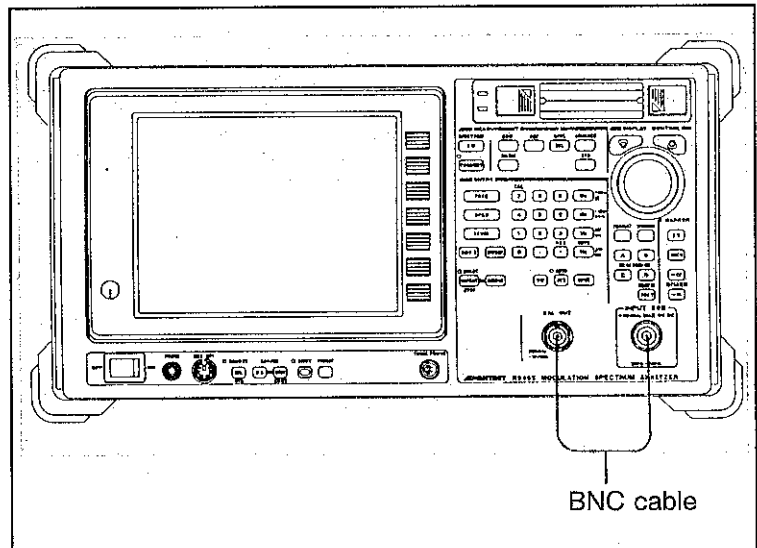

Figure 3-8 Connection for power level measurement

4 Press **LEVEL**, **0** and **GHz** <sup>+dBm</sup>/<sub>sec</sub> keys to set reference level to 0 dBm.

5 Press **FREQ**, **3**, **0** and **MHz** keys to set center frequency to 30 MHz.



6

Press **SPAN** , **5** and **MHz** keys to set frequency span to 5 MHz.

7

Press **SRCH** key to display a marker at the maximum level on the screen.

The level at marker position is displayed at upper right on the screen.

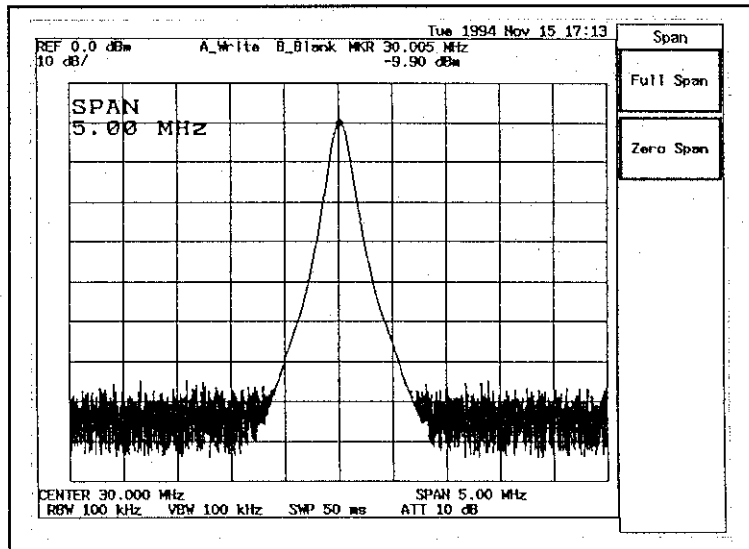

Figure 3-9 Power level measurement for 30 MHz CAL signal

● Power level measurement by increased display resolution

1

Press  key to set marker level to reference level.

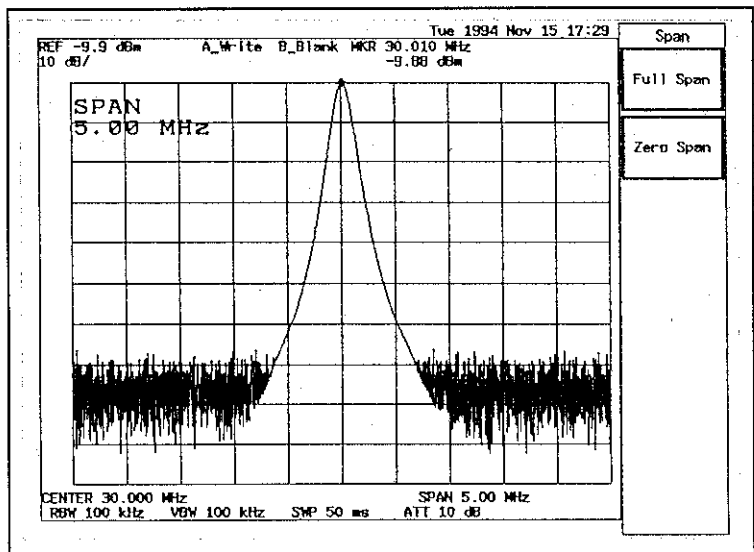

Figure 3-10 Reference level setting

2

Press , , and  keys.

3

Press , , and  keys to set frequency span to 1 MHz.

4

Press , , , , , and  keys to set RBW to 300 kHz.

5

Press , , , and  keys to set VBW to 30 kHz.

5. Measuring the power level

6

In the case that the displayed level is changed by the changing of RBW at this time, press  again to set to the reference level.

Press  key to display a marker at the maximum level on the screen.

The power level at the marker position is displayed at upper right on the screen.

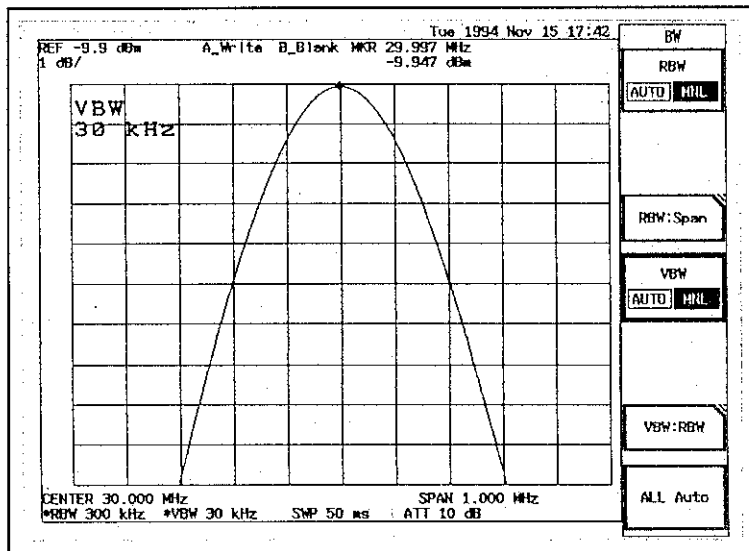

Figure 3-11 Power level measurement by increased display resolution



## 6. Measurement of Frequency

### ■ Measurement with normal marker

1 Press **SHIFT** and **PRESET** keys to reset to initial setting.

2 Connect the N-BNC adapter to the INPUT connector on the front panel.

3 Connect CAL OUT and INPUT connectors on the front panel with the BNC cable (150mm).

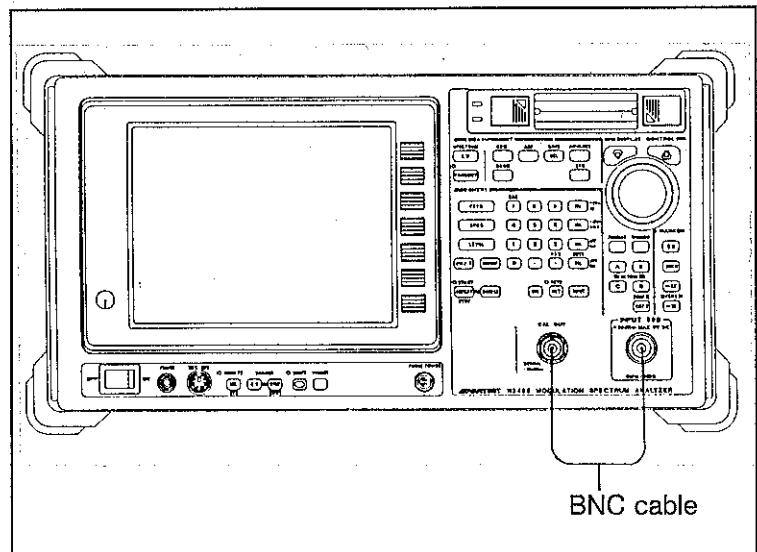

Figure 3-12 Connection for frequency measurement

4 Press **LEVEL**, **0** and **GHz** <sup>+dBm</sup>/<sub>sec</sub> keys to set reference level to 0 dBm.

5 Press **FREQ**, **3**, **0** and **MHz** keys to set center frequency to 30 MHz.



6. Measurement of Frequency

6

Press **SPAN** , **5** and **MHz** keys to set frequency span to 5 MHz.

7

Press **SRCH** key to display a marker at the maximum level on the screen.

The frequency at marker position is displayed at upper right on the screen.

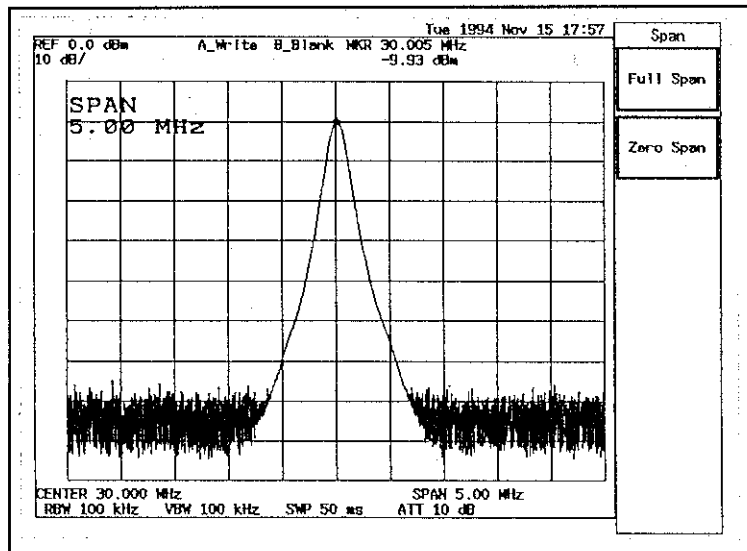

Figure 3-13 Frequency measurement for 30 MHz CAL signal

## ■ Measurement by frequency counter

For continuous carrier signal, frequency can accurately be measured in COUNTER mode.

When frequency is measured with normal marker, the measured data corresponds to the position at which the marker is displayed and includes errors related to span accuracy, display resolution, etc.

In COUNTER mode frequency of the signal is measured directly by the frequency counter, so that measuring accuracy is increased to the accuracy of reference source. However, when the difference in level between marker point and displayed noise level is 25 dB or less, or when SPAN value is 1 GHz or more, measurement may not be accurate.

- 1 Press **SHIFT** and **PRESET** keys to reset to initial setting.
- 2 Connect the N-BNC adapter to the INPUT connector on the front panel.
- 3 Connect CAL OUT and INPUT connectors on the front panel with the BNC cable (150mm).

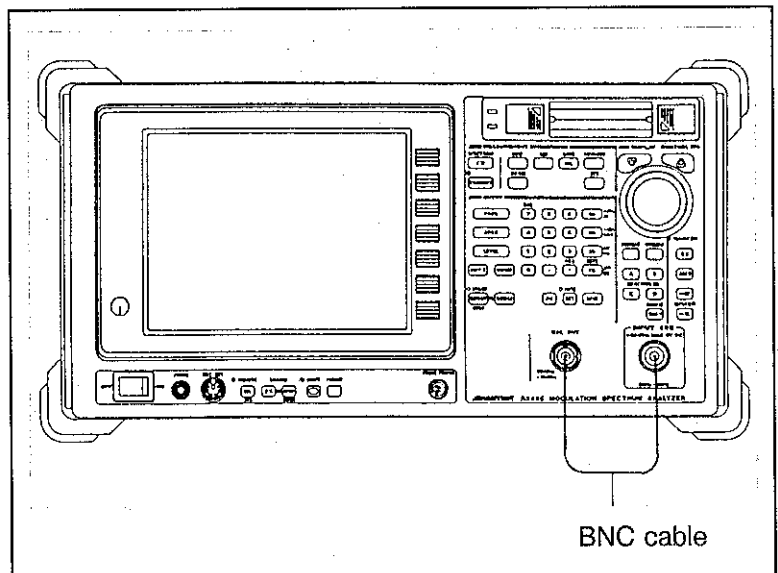

Figure 3-14 Measurement by frequency counter

6. Measurement of Frequency

4 Press  ,  ,  ,  ,  and  <sup>+dBm</sup>/<sub>sec</sub> keys to set reference level to -10 dBm.

5 Press  ,  ,  and  keys to set center frequency to 30 MHz.

6 Press  ,  and  keys to set frequency span to 5 MHz.

7 Press  key to display a marker at the maximum level on the screen.

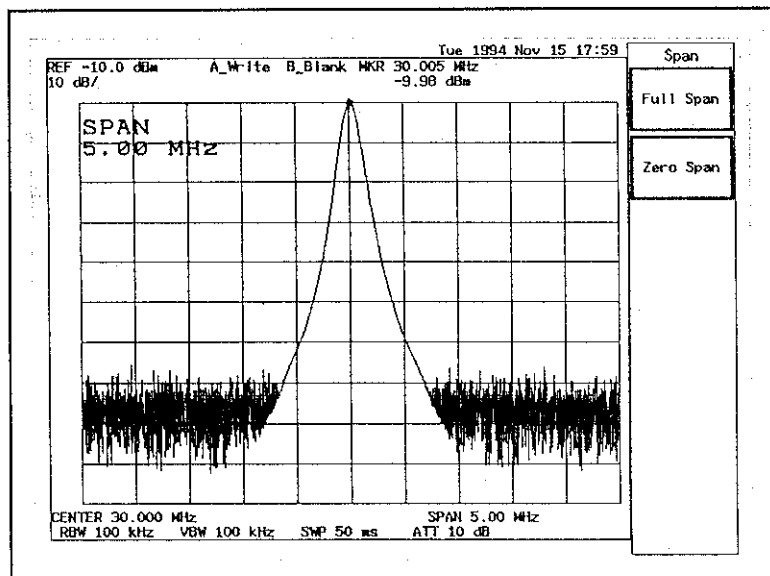

Figure 3-15 Display of maximum level at marker point

8 Press  ,  and    keys to set to COUNTER mode.



9

Press Resolution  
1Hz key to set counter resolution to 1

Hz.

Then the frequency in MARKER mode at marker position is displayed at upper right on the screen.

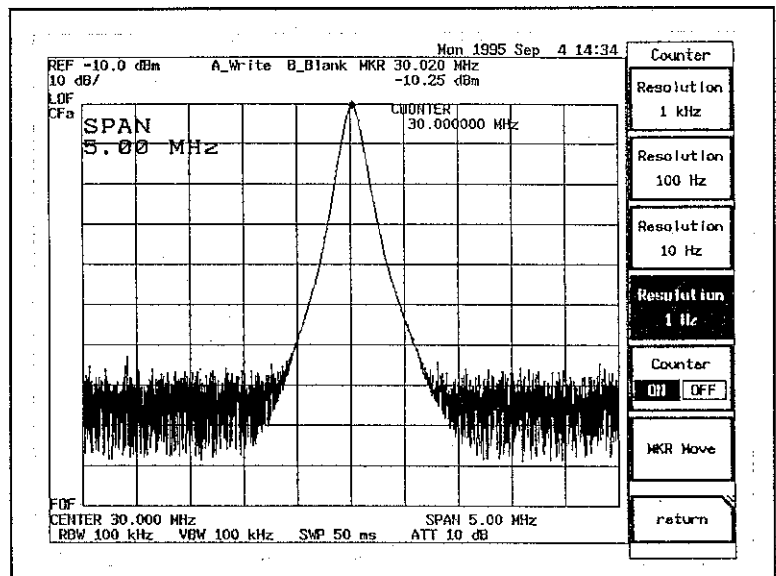

Figure 3-16 Frequency measurement in COUNTER mode

## Convenient functions MKR⇒CF, MKR⇒REF

### ● MKR⇒CF function

This function makes the frequency at active marker position the center frequency.

It is very useful to, for example, adjust unknown frequency to center frequency.

<When peak level of waveform >



Press ⇒CF key.

Then the frequency at peak level point on the screen becomes the center frequency.

<When not peak level of waveform >



Press MARKER ON key, and turn the data knob to move the marker to the frequency point which is the center frequency.

Press more 1/3, Marker⇒ and MKR⇒CF keys.

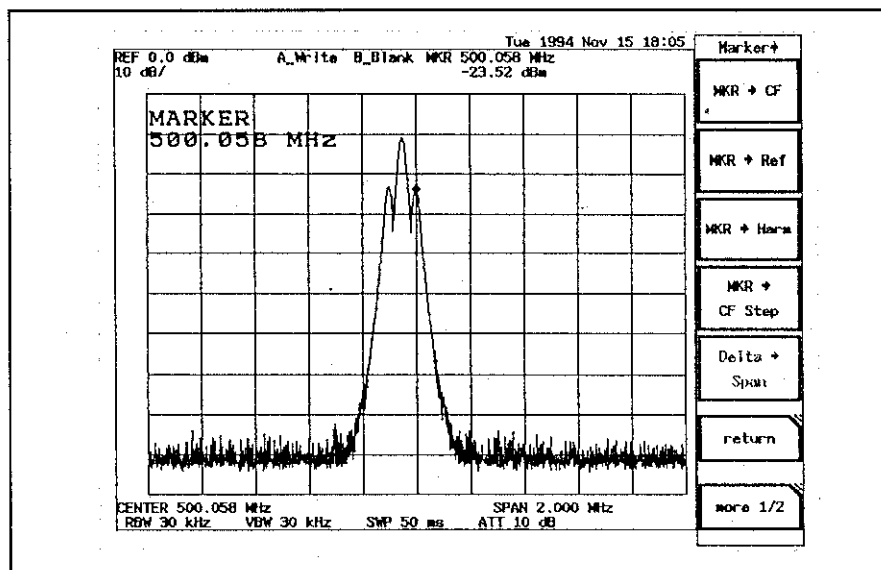

Figure 3-17 MKR⇒CF function

● MKR⇒REF function

This function makes the level at active marker position the reference level.

It is very useful to, for example, adjust the peak level of waveform to reference level.

<When peak level of waveform >

1 Press  key.

Then the peak level on the screen becomes the reference level.

<When not peak level of waveform >

1 Press  key, and turn the data knob to move the marker to the level point which is the reference level.

2 Press , , and  keys.

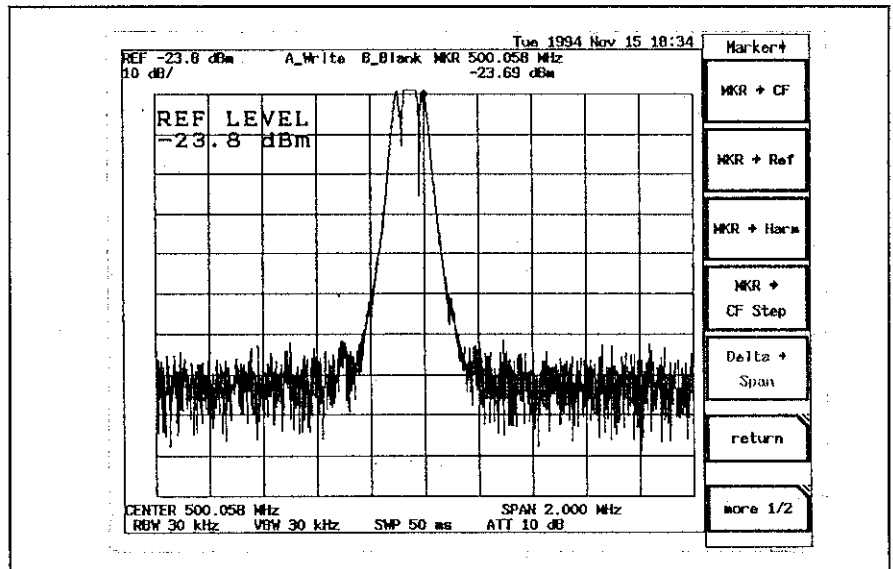

Figure 3-18 MKR⇒REF function

## 7. Dynamic Range and Sweep Rate

1 Press **SHIFT** and **PRESET** keys to reset to initial setting.

2 Connect the N-BNC adapter to the **INPUT** connector on the front panel.

3 Connect **CAL OUT** and **INPUT** connectors on the front panel with the BNC cable (150mm).

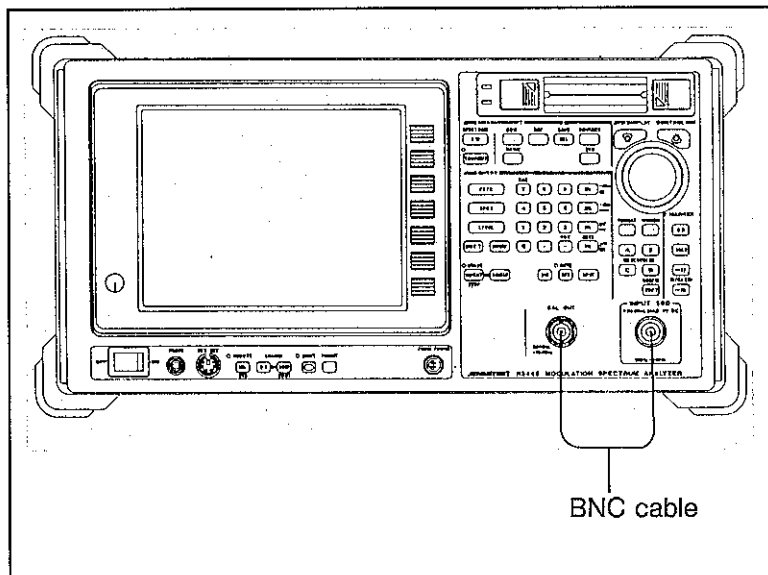

Figure 3-19 Dynamic range and sweep rate

4 Press **LEVEL**, **B.S**, **-**, **1**, **0** and **GHz** <sup>+dBm</sup>/<sub>sec</sub> keys to set reference level to -10 dBm.

5 Press **FREQ**, **3**, **0** and **MHz** keys to set center frequency to 30 MHz.





6

Press **SPAN** , **5** , **0** and **MHz** keys to set frequency span to 50 MHz.

7

Press **BW** , **RBW** (with **AUTO** and **MNL** sub-options), **1** , **0** , **0** and **MHz** keys to set RBW to 100 kHz.

Then display noise level decreases by 10 dB, expanding the display dynamic range.

8

Press **VBW** (with **AUTO** and **MNL** sub-options), **1** , **0** and **kHz** keys to set VBW to 10 kHz.

Setting VBW to approximately 1/10 of RBW averages noise level and obtains wider dynamic range.

Here, setting to "auto" automatically sets sweep rate . If sweep time is forcibly set to, for example, 50 ms, measurement cannot be made correctly due to the error of displayed waveform.

To obtain a high sweep rate, it is necessary to set as follows:

- Make RBW wider.
- Make VBW wider.
- Make frequency span narrower when RBW/VBW does not change.

## 8. Switching Standard Measurement Function

For the models which have the GSM/DECT/CDMA measurement options installed, it is necessary to switch the system between the standard measurements. The switching operation is made as a system function operation.

- 1 Press  then  keys to display the dialog box in Figure 3-20.

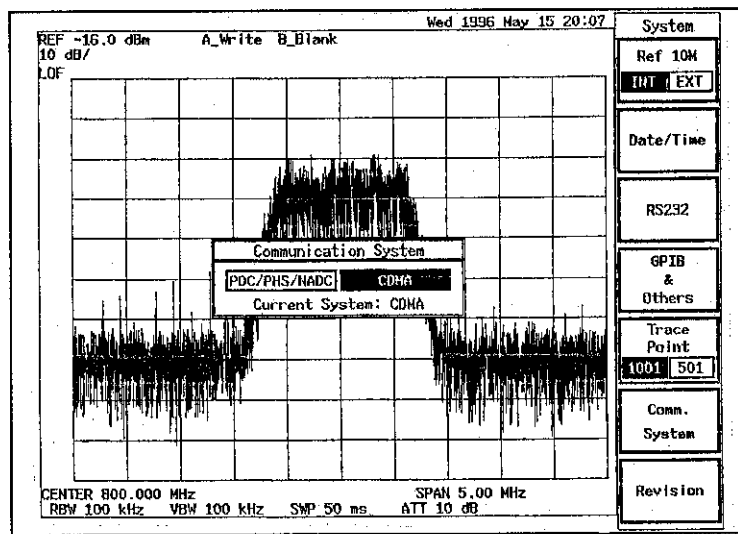

Figure 3-20 Dialog Box

- 2 Select a communication system (PDC/PHS/NADC (or GSM) or CDMA) with the data knob.

- 3 Press the  key or turn the data knob to determine the setting.

Then a box for a confirmation appears. If you want to make the setting effective, select "Confirm". If making it ineffective, select "Cancel" and press the  key.

- 4 If the power is turned off once then turned on, the communication system to be measured and the menu for measurement are switched. Then either PDC/PHS/NADC standard measurement (or GSM standard measurement) or CDMA standard measurement becomes executable according to your selection.

### NOTE

After the system is switched by using Comm. System, always execute a calibration.

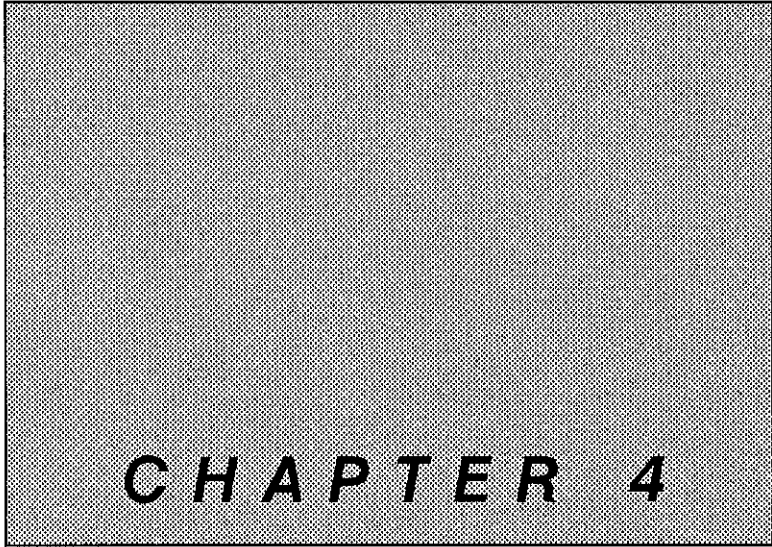

**CHAPTER 4**

**BASIC OPERATION**

This chapter explains basic operation, such as power-on and initialization.

---

**CONTENTS**

---

1. When the Power is Turned ON .....	4-2
2. When a High Level Signal Exists outside the Displayed Span .....	4-3
3. Local Feedthrough .....	4-5
4. Initialization .....	4-6

---

## 1. When the Power is Turned ON

### ■ Reference frequency

Table 4-1 shows the accuracy for the built-in reference crystal oscillator. This instrument starts warming up the built-in reference crystal oscillator when the power is turned ON.

**Table 4-1 Warm-up time for built-in reference crystal oscillator**

Starting characteristic (10 minutes after powering up)	$5 \times 10^{-8}$ or less
Aging rate (after 24 hours operation)	$2 \times 10^{-8}$ /day or less

### ■ Setting

Turning the power ON invokes the setting which was effective when the power was last turned OFF.

Pressing  and  keys initializes the panel setting.

## 2. When a High Level Signal Exists outside the Displayed Span

For proper level of measured signal, mixer input level must be  $-10$  dBm or less. Exceeding this level causes input mixer to saturate or distort, leading to inaccurate measurement such as dropping of display level or increased spurious. Therefore, it is necessary to attenuate the signal to measure down to a proper level.

For base band (0 to 1.7 GHz or 0 to 3 GHz) of R3463 and R3465, all input signals in the band are added to the mixer. Therefore, depending on the signals to measure, saturation or distortion may occur due to high level signals out of display screen. To avoid this, 2 methods are available:

- ① Before starting measurement, check the maximum level of the signal, with span set to "Full Span".
- ② With the setting of input ATT incremented by 10 dB, check that signal levels in the display level do not change.

In 1.7 to 8.0 GHz range of the R3465, signals are added to the mixer via preselector and therefore the signals out of the measuring frequency range are suppressed by approximately 70 dB, relieving the distortion due to the signals out of the bandwidth.

For example, when 2nd-order harmonic of 850 MHz or higher frequency is measured, the fundamental harmonic is suppressed to obtain wider dynamic range.

Following is a sample setting for method ②:

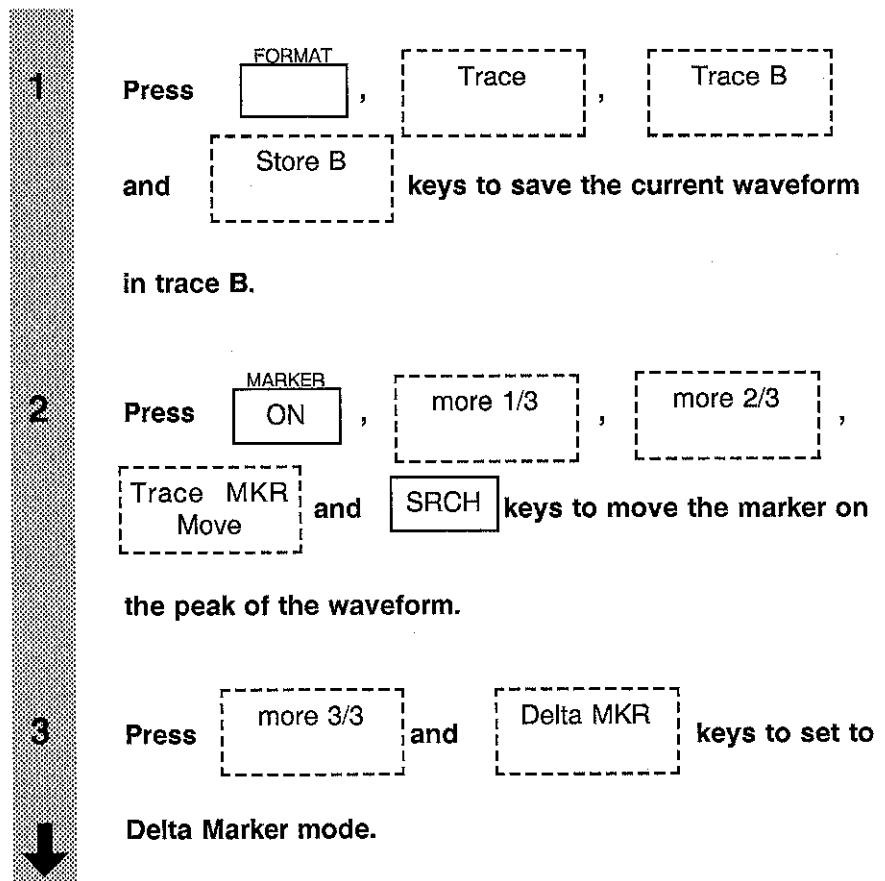

2. When a High Level Signal Exists outside the Displayed Span

4

Press more 1/3, more 2/3 and Trace MKR  
Move

keys to move the active marker on trace A.

5

Press ATT and ATT Auto  
AUTO MNL keys to select MNL, and increment the setting of ATT by 10 dB with the step key.

At that time, check that the reference level does not change.

6

Press MARKER  
ON, Peak and Next Peak

keys to adjust the maker at the peak of the waveform, and read the level change.

Compare the currently displayed waveform with that saved in trace B. When the level drop is approximately 1 dB or less, it is concluded that measurement can be made without distortion or saturation.

### 3. Local Feedthrough

With a superheterodyne type spectrum analyzer, spectrum is measured even when no signal is input, because at the frequency corresponding to 0 Hz, 1st local frequency coincides with 1st intermediate frequency. This spectrum is called "local feedthrough". It can be used to check accurate 0 Hz position, on the other hand it may narrow the dynamic range around 0 Hz.

## 4. Initialization

It is possible to reset to the initial setting made at shipment or defined by user. The procedure for this is as follows:

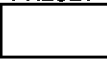

Press  and  key to reset to the initial setting.



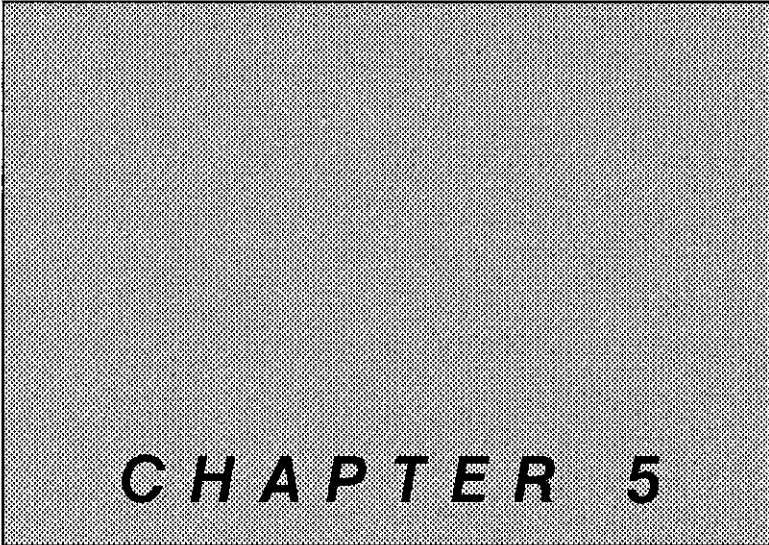

**CHAPTER 5**

**SAMPLE MEASUREMENT**

This chapter explains how to operate the instrument, showing several sample measurements.

---

**CONTENTS**

---

1. Measurement of Frequency .....	5-2
2. Measuring the modulation frequency and modulation index of AM signal .....	5-5
3. Measurement of FM Wave .....	5-13
4. Measurement of Pulse Modulated Wave ..	5-24
5. Spectrum Analysis of Burst Signal .....	5-26
6. How to measure transmitter test .....	5-27

---

# 1. Measurement of Frequency

## ■ Sample measurement of approximately 200 MHz signal source

### ● Frequency measurement with normal marker

Display the input signal so that it can easily be monitored, and move the marker at the peak point.

1 Press **FREQ** , **2** , **0** , **0** and **MHz**

keys to set center frequency to 200 MHz.

2 Press **SPAN** , **1** , **0** , **0** and **MHz**

keys to set frequency span to 100 MHz.

3 Press **SRCH** key.

Then the frequency at the marker point is displayed at upper right on the screen.

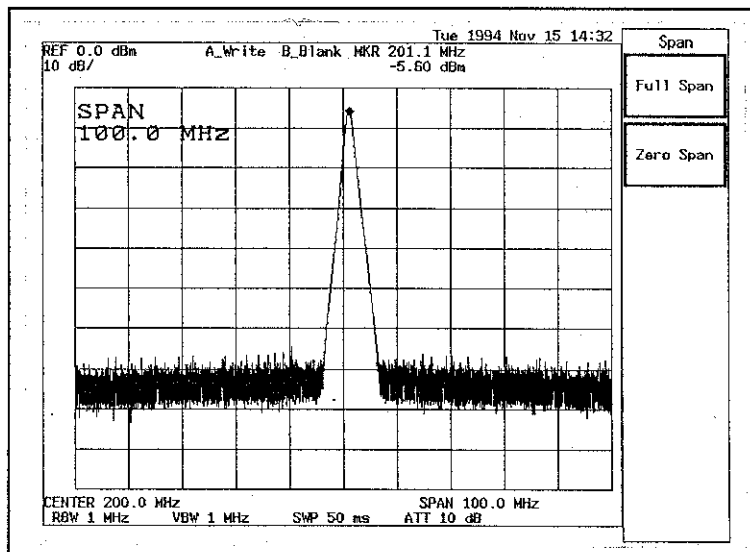

Figure 5-1 Frequency measurement with normal marker

### REFERENCE

$$\text{Measuring accuracy} = \pm (\text{Reading of marker frequency} \times \text{Frequency reference accuracy} + \text{Span} \times \text{Span accuracy} + 0.15 \times \text{Resolution bandwidth} + 10 \text{ Hz})$$

● **Frequency measurement in frequency counter mode**

Select frequency counter mode, and set counter measurement resolution.

**CAUTION !**

1. *In the following cases, frequency counter mode may not display correct value.*
  - *When span > 1 GHz*
  - *When the difference in noise level from marker point value is 25 dB or less*
2. *Frequency counter mode cannot be used with SIGNAL TACK mode.*

1

Press  ,  and  keys to set measuring frequency resolution to 10 Hz.

2

Set  key to ON to enter frequency counter mode.

Then the frequency at marker point is displayed at upper right on the screen with 10 Hz resolution.

In this mode, frequency of input signal can be measured even when the marker is not on the peak point.

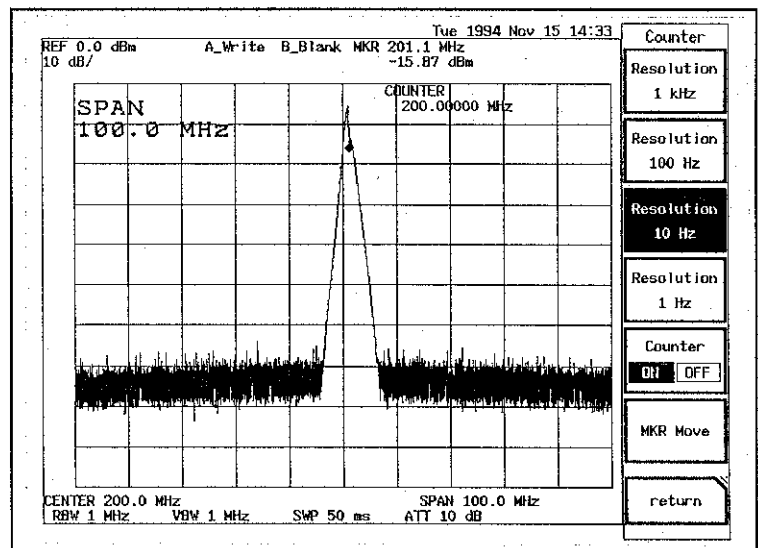

Figure 5-2 Frequency measurement in frequency counter mode

**REFERENCE**

*Measuring accuracy* =  $\pm$  (Read value of marker frequency x  
Frequency reference accuracy + 5 Hz x N  
+ 1 LSD)

*LSD : Least Significant Digit*

Frequency band	N: order of mixer
9 kHz to 3.0 GHz	N = 1
1.7 GHz to 7.0 GHz	N = 1
6.9 GHz to 8.0 GHz	N = 1

## 2. Measuring the modulation frequency and modulation index of AM signal

Compared with time-domain oscilloscopes, a spectrum analyzer shows excellent performance in measuring signal of low modulation degree, such as residual AM and residual FM.

Time-domain measurement calculates the modulation index of AM wave using the following formula (see Figure 5-3 (a)).

$$m = \{(E_{\max} - E_{\min}) / (E_{\max} + E_{\min})\} \times 100$$

With the spectrum analyzer, we can read the level difference of the sidebands to the carrier in dB. (See Figure 5-3 (b).)

In addition, the modulation degree of the modulated signal with respect to higher harmonics can be obtained individually. Especially when modulation degree is low, time-domain measurement is in units of 2%, while spectrum analyzer can measure down to less than 0.02%.

The measuring accuracy becomes higher in LINEAR mode when modulation degree is equal to or higher than 10%, while higher in LOG mode when modulation degree is lower than 10%.

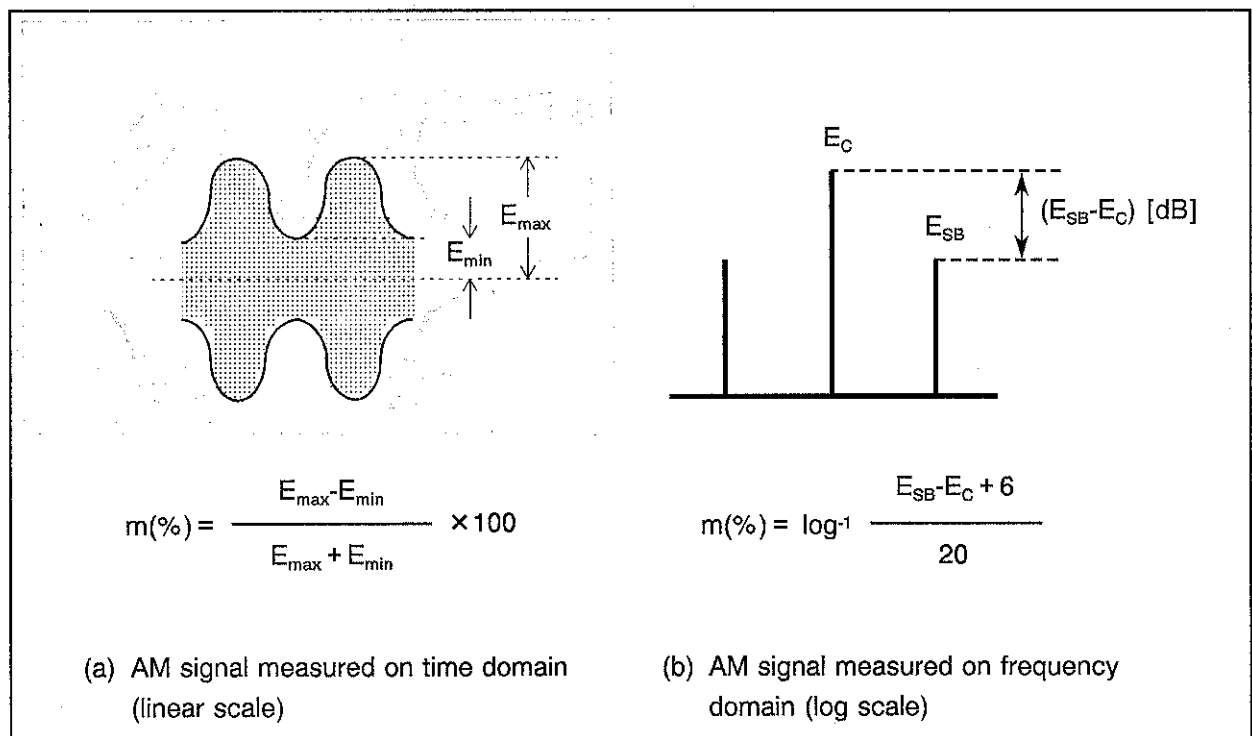

Figure 5-3 Measurement of AM signal

2. Measuring the modulation frequency and modulation index of AM signal

■ Sample measurement of AM wave of low modulation degree and high modulation index

Measurement is made on time domain with linear scale.

1

Display the signal to measure, and adjust the peak to reference level.

In this example, carrier is set to 903 MHz.

Press **FREQ**, **9**, **0**, **3** and **MHz** keys and then **SPAN**, **2**, **0** and **MHz** keys.

Press **LEVEL** key, and turn the data knob so that the peak of signal level is equal to the reference level line.

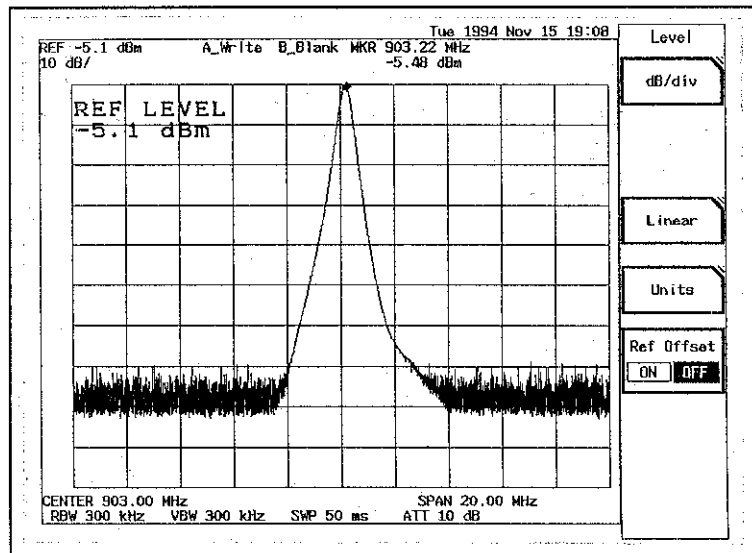

Figure 5-4 Adjusting the signal level

2

Press **BW** and **RBW** keys to select **MNL**, and set resolution bandwidth to 3 times or more of modulation frequency.



## 2. Measuring the modulation frequency and modulation index of AM signal

3

Press **LEVEL** and **Linear** keys to set the vertical scale to "Linear".

4

Press **SPAN** and **Zero Span** keys to set to Zero Span mode.

5

Press **FORMAT**, **Trace Detector** and **Sample** keys to set trace detector to "Sample".

6

Press **LEVEL** key, and turn the data knob so that the peak of signal level is equal to the reference level line.

7

Press **SWEEP**, **Trigger Source** and **Video** keys to set trigger mode to Video.

8

Press **SWP T** and **Swp Time** keys to select **MNL**, and operate the step key to set sweep time to a value which makes it easy to monitor waveform.

Press **Single** to stop the sweeping temporarily.

9

Press **MARKER ON** and **Peak** keys to move the marker on the peak of waveform.



2. Measuring the modulation frequency and modulation index of AM signal

**10** Press more 1/2, return, Delta MKR, Peak and Next Peak keys.

The period of modulated wave T(s).

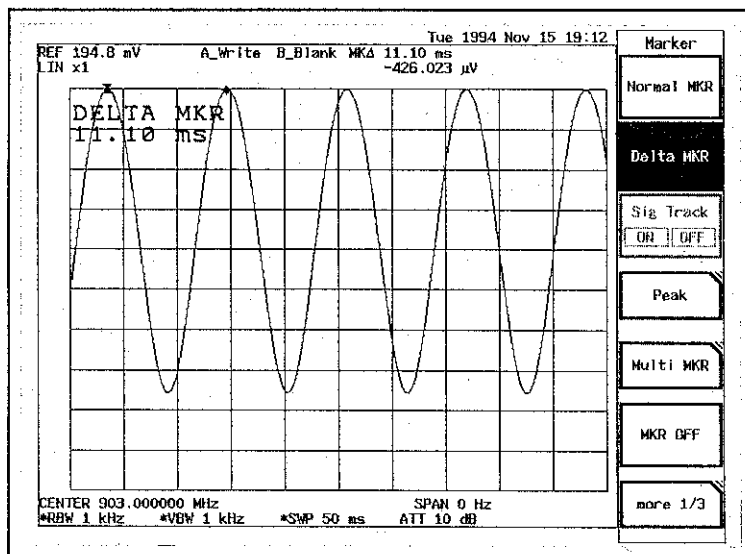

Figure 5-5 Measuring the period of modulated wave

**11** Press more 1/2, return, more 1/3 key and set 1/Delta MKR key to ON to obtain

modulation frequency.

**12** Press MARKER  
ON and Normal MKR keys to move the marker to the maximum point of waveform, and record the level (E<sub>max</sub> value).



2. Measuring the modulation frequency and modulation index of AM signal

13

With data knob, move the marker to the minimum point of waveform, and record the level (Emin value).

Assign these values to the following formula to calculate modulation index m.

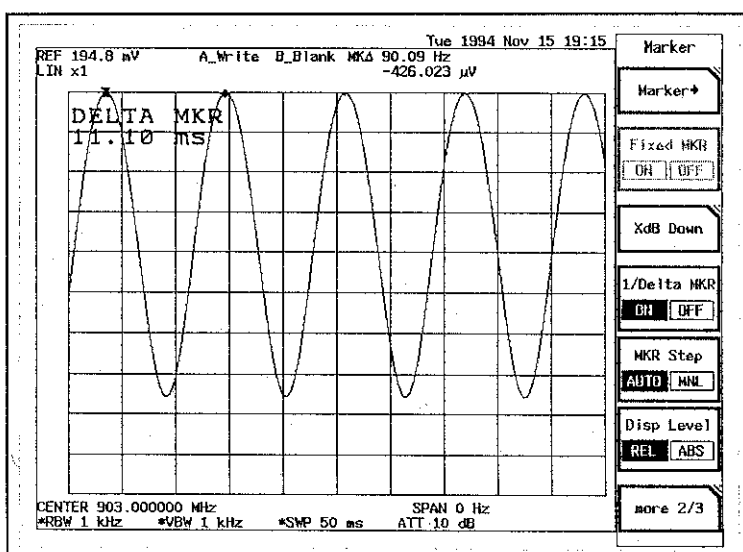

Figure 5-6 Modulation frequency of AM wave

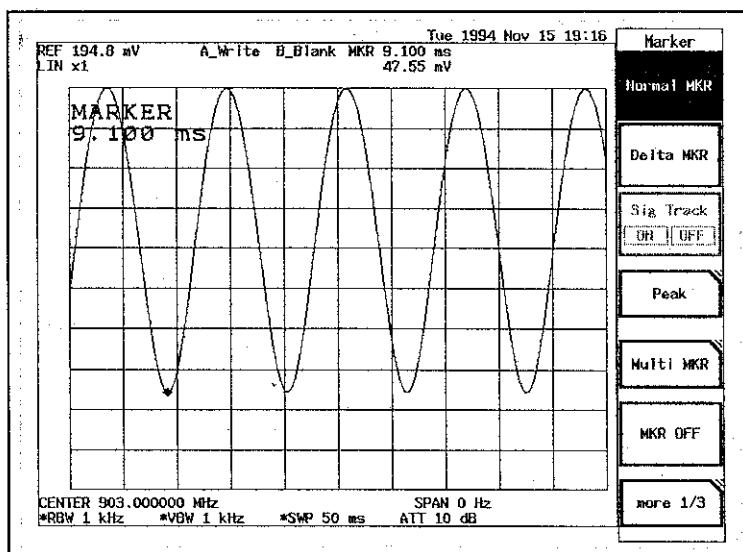

Figure 5-7 Modulation index of AM wave

2. Measuring the modulation frequency and modulation index of AM signal

■ Sample measurement of AM wave of high modulation frequency and low modulation index

Measurement is made on frequency domain of log scale.

1 Press **SPAN** key, and operate the step key to set frequency span to a value which is greater than twice the modulation frequency but smaller than 10 times.

2 Press **FREQ** key, and turn the data knob to set center frequency to the carrier frequency.

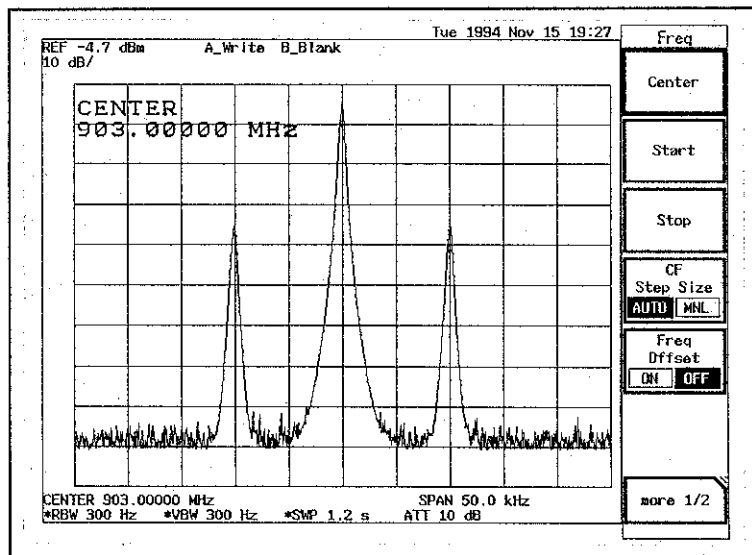

Figure 5-8 Setting of center frequency

3 Press **MARKER ON** and **Peak** keys to move the marker to the peak of the carrier.



## 2. Measuring the modulation frequency and modulation index of AM signal

4

Press more 1/2, return and Delta MKR

keys, and turn the data knob to move the delta marker to the peak of the spectrum of modulated signal.

From the frequency at delta marker point and displayed level value, modulation frequency  $f_m$  and modulation index  $m$  are calculated using the following formulae.

$f_m$  = Frequency at delta marker

$$m = \log^{-1} \frac{E_{SB} - E_C + 6}{20}$$

Figure 5.10 shows the relation between  $E_{SB} - E_C$  [dB] and  $m$  [%].

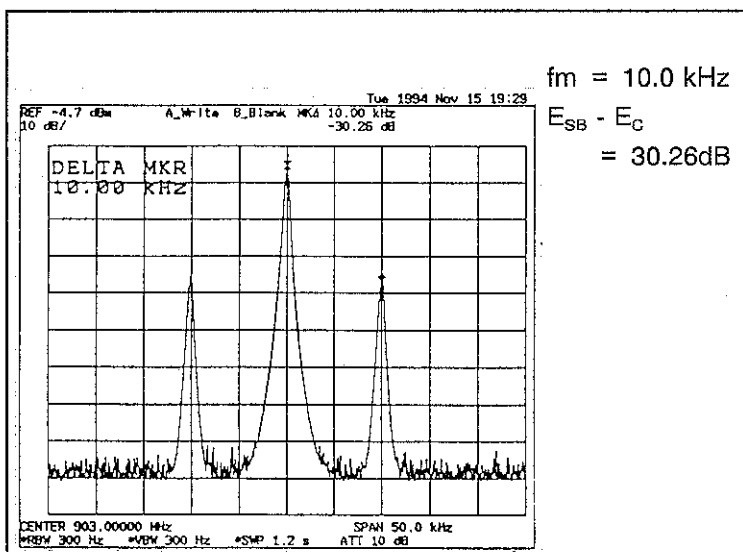

Figure 5-9 AM wave of high modulation frequency and low modulation index

2. Measuring the modulation frequency and modulation index of AM signal

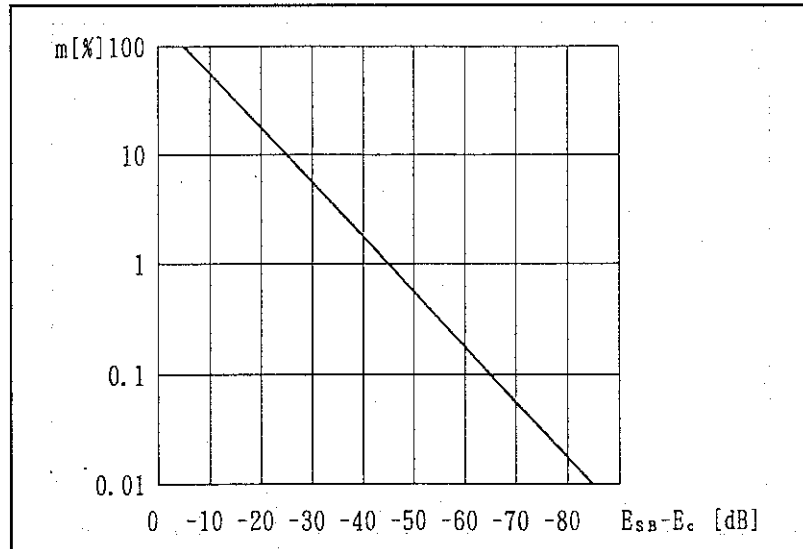

Figure 5-10 Relation between sideband level-carrier level ( $E_{SB} - E_C$ ) and modulation index  $m$ (%)

### 3. Measurement of FM Wave

For FM wave, in general, carrier frequency  $f_c$ , modulated wave frequency  $F_m$ , frequency deviation  $\Delta f_{\text{peak}}$ , modulation index  $m$ , occupied bandwidth etc. are measured.

Modulation index  $m$  of FM wave can be expressed by  $\Delta f_{\text{peak}}/f_m$ . The relation which makes the carrier lowest when modulation index is 2.4, 5.6, 8.6, .... is obtained to calculate modulation index  $m$  or frequency deviation  $\Delta f_{\text{peak}}$  (see Figure 5-11 (a) and (b)).

It is often the case with FM wave that we cannot understand the content of modulation only with the spectrum but can understand when FM component of input signal is converted into and displayed by the change of amplitude.

In this case, discriminator is used additionally. But spectrum analyzer can detect utilizing the slope of IF and B.P.F. The modulated wave thus detected is displayed on the screen (see Figure 5-11 (c)).

When modulation frequency is low, set the horizontal axis to Zero Span to operate as a fixed modulation receiver. Measurement is made in time domain.

When modulation frequency is high, measurement is made in frequency domain, and modulation frequency is obtained from sideband frequency.

When modulation index  $m$  is small (approximately 0.8 or less),  $m$  is obtained from the relation between carrier level and 1st sideband level.

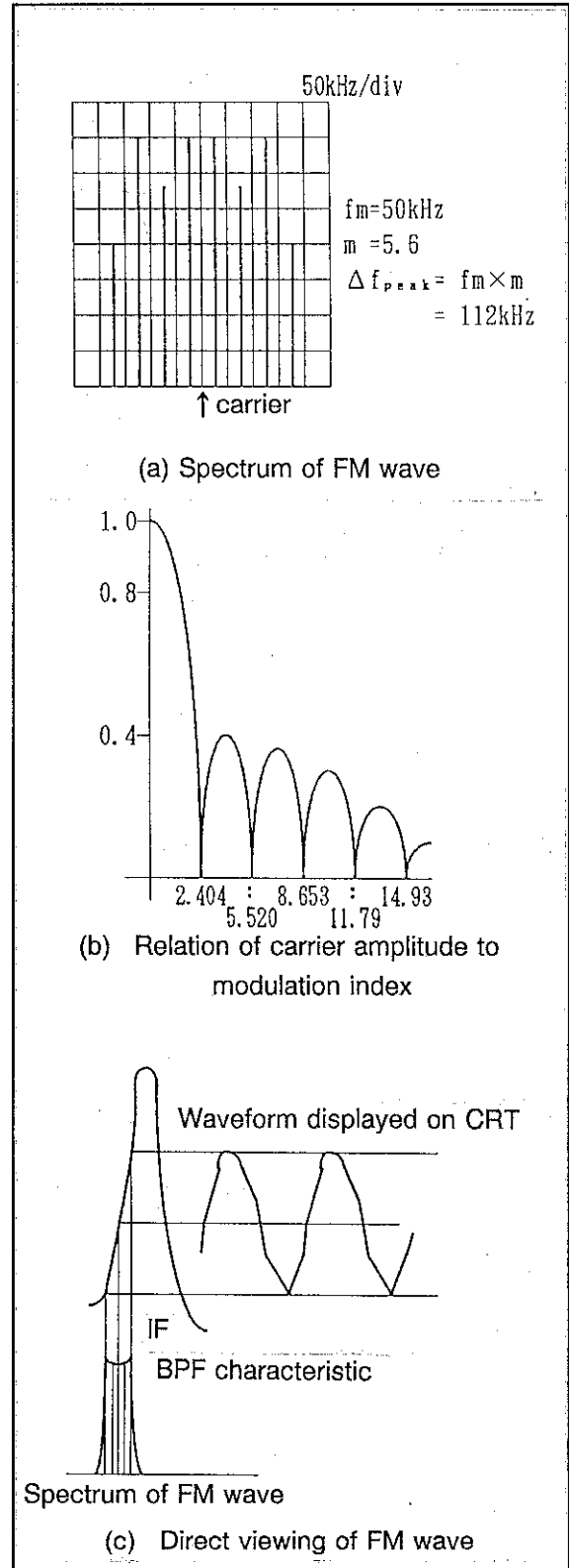

Figure 5-11 Measurement of FM wave

### Sample measurement of FM wave of low modulation frequency

1 Press **FREQ** key, and operate the step key or data knob to adjust the carrier at center frequency.

2 Press **BW** and **RBW** keys to select MNL, and operate the step key to set resolution bandwidth to 3 times or more of modulation frequency.

3 Press **LEVEL** key, and turn the data knob so that the peak of signal level is equal to the reference level line.

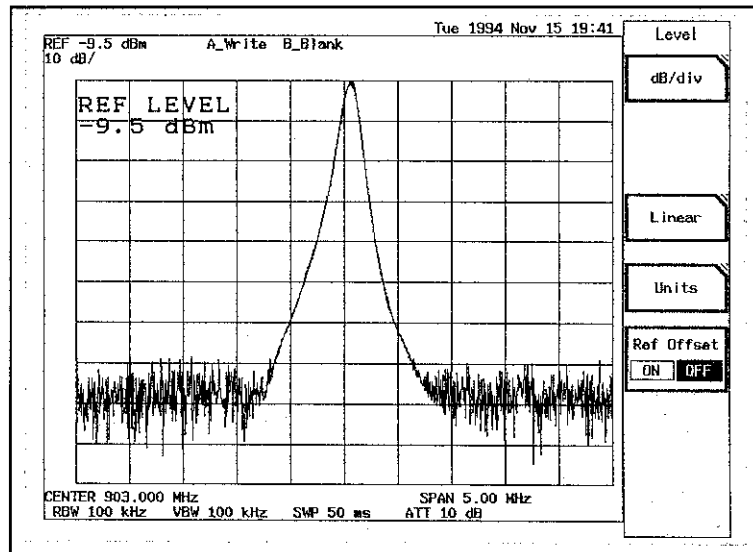

Figure 5-12 Adjustment of signal level

4 Press **SPAN** and **Zero Span** keys to enter Zero Span mode.



5 Press **FREQ** key, and operate the step key or data knob to change the center frequency so that the modulated waveform is displayed at the center on the screen.

6 Press **SWEEP**, **Trigger Source** and **Video** keys to set trigger mode to Video.

7 Press **SWP T** and **SWP Time** keys to select **MNL**, and operate the step key to adjust sweep time so that modulated wave can easily be seen on the screen.

8 Press **MARKER ON** and **Peak** keys.

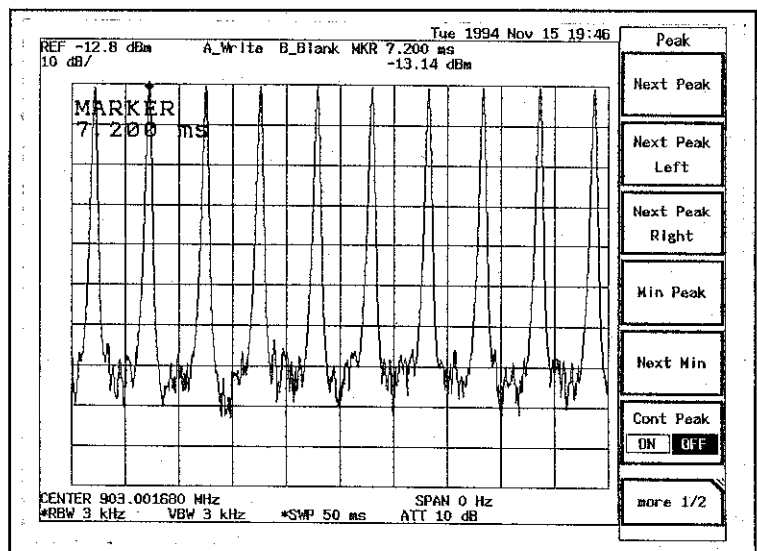

Figure 5-13 Moving the marker to the peak of modulated wave

9

Press more 1/2, return and Delta MKR keys to move the delta marker to the adjacent peak with the data knob.

10

Press more 1/3 and set 1/Delta MKR to ON to calculate modulation frequency  $f_m$ .

$$f_m = \frac{1}{T(s)}$$

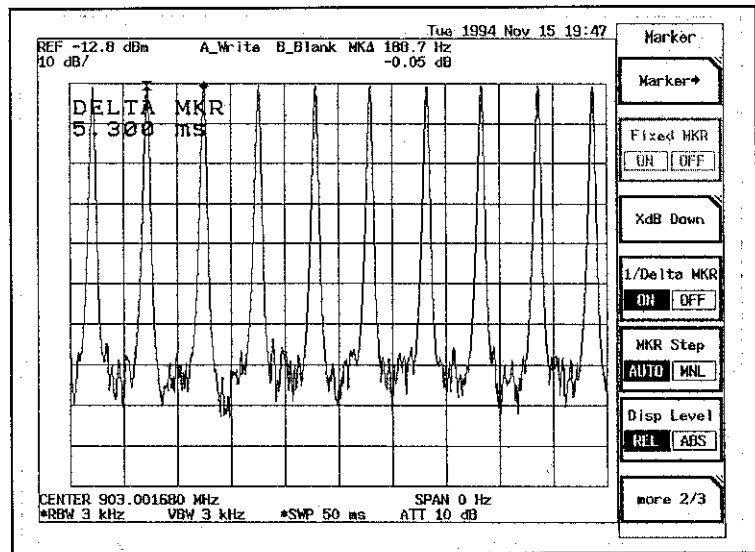

Figure 5-14 FM wave of low modulation frequency



■ Sample measurement of FM wave of high modulation frequency and low m value

1 Press **SPAN** key, and operate the step key to set frequency span to a value greater than twice the modulation frequency but smaller than 10 times that.

2 Press **FREQ** key and turn the data knob to adjust carrier frequency at center frequency.

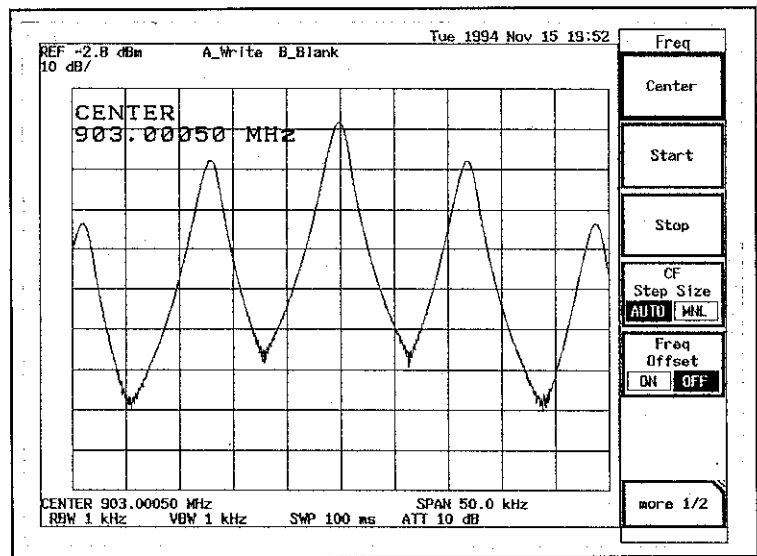

Figure 5-15 Adjusting carrier frequency at center frequency

3 Press **MARKER ON** and **Peak** keys to move the marker on the peak of carrier.

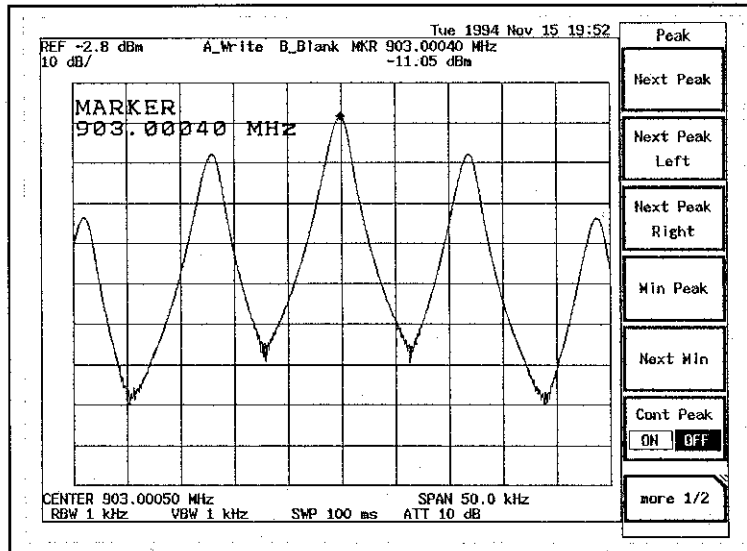

Figure 5-16 Carrier peaks

4

Press more 1/2, return and Delta MKR

keys and turn the data knob to move the delta marker to the peak of adjacent sideband signal.

Then the displayed frequency value for the marker position becomes the modulation frequency fm.

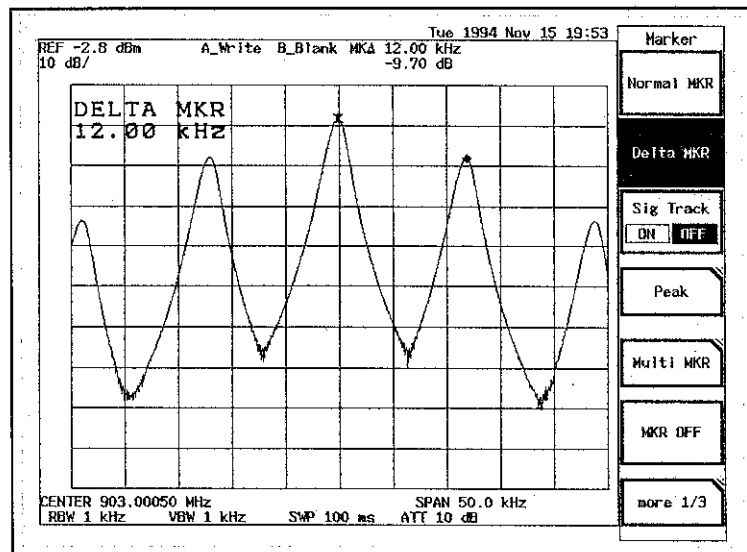

Figure 5-17 FM wave of high modulation frequency and low m value

■ Sample measurement of the deviation of FM wave peak ( $\Delta f$  peak)

1

Press **BW** and **RBW** keys to select MNL, and operate the step key to set resolution bandwidth to a value which includes main sidebands (5 times the modulation frequency or more).

2

Press **FREQ** key and turn the data knob to adjust center frequency at the carrier frequency.

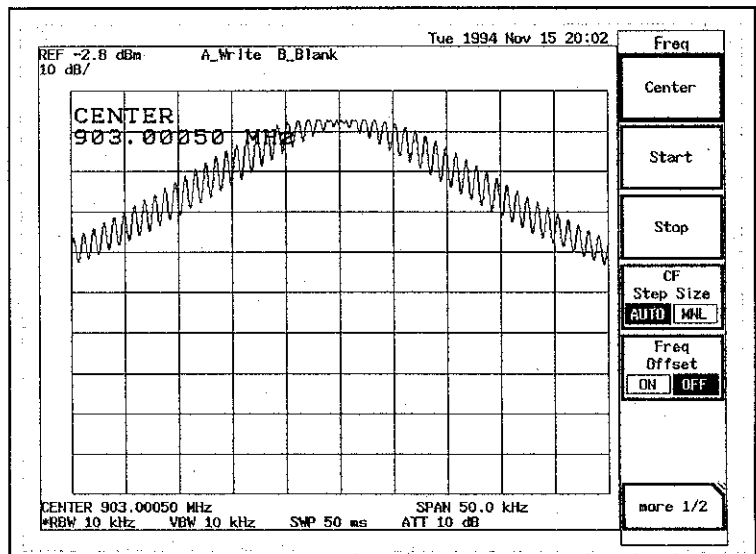
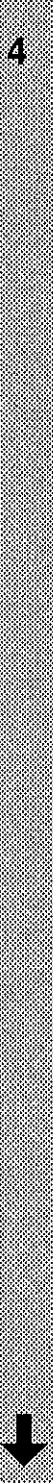

Figure 5-18 Adjusting center frequency at the carrier frequency

3

Press **SPAN** key and operate the step key to set frequency span to a value which makes it easy to monitor waveform, according to peak deviation.





**From the waveform, measure  $\Delta f_{\text{peak peak}}$**

$\Delta f_{\text{peak}}$  and modulation index  $m$  are calculated using the following formulae.

$$\Delta f_{\text{peak}} = \frac{1}{2} \Delta f_{\text{peak peak}}$$

$$m = \frac{\Delta f_{\text{peak}}}{f_m}$$

- When  $\Delta f_{\text{peak}}$  is small

$$\begin{aligned} \Delta f_{\text{peak peak}} &= \text{Frequency at delta marker} \\ &= 5.30 \text{ kHz} \end{aligned}$$

$$\begin{aligned} \Delta f_{\text{peak}} &= \frac{1}{2} \Delta f_{\text{peak peak}} \\ &= 2.65 \text{ kHz} \end{aligned}$$

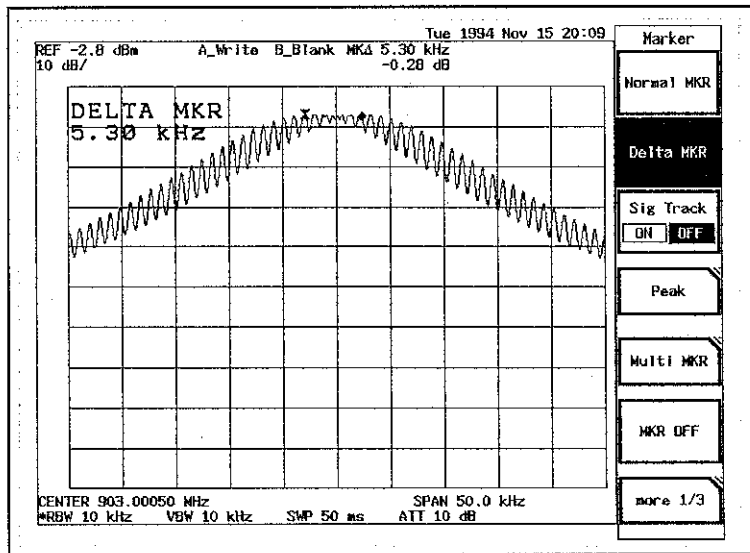

Figure 5-19 FM wave with small  $\Delta f_{\text{peak}}$

- When  $\Delta f_{\text{peak}}$  is large

$$\begin{aligned} \Delta f_{\text{peak peak}} &= \text{Frequency at delta marker} \\ &= 295 \text{ kHz} \end{aligned}$$

$$\begin{aligned} \Delta f_{\text{peak}} &= \frac{1}{2} \Delta f_{\text{peak peak}} \\ &= 147.5 \text{ kHz} \end{aligned}$$

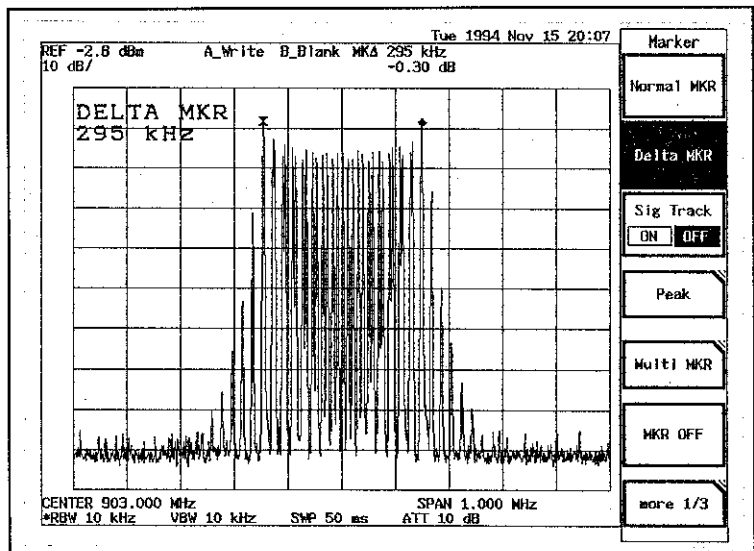

Figure 5-20 FM wave with large  $\Delta f_{\text{peak}}$

### How to obtain m when FM modulation index m is small

For FM wave with 0.8 or smaller modulation index m, the following formula can be used.

$$m = \frac{2E_{SB}}{E_C} \quad \begin{array}{l} E_{SB} : \text{Level of 1st sideband} \\ E_C : \text{Level of carrier} \end{array}$$

On the screen of log scale,

$$M = \log^{-1} \frac{E_{SB} - E_C + 6}{20} \quad \begin{array}{l} E_{SB} - E_C : \text{Difference in level between} \\ \text{1st sideband and carrier [dB]} \end{array}$$

1

Properly set center frequency and frequency span so that carrier can easily be monitored, and adjust carrier level to the reference level.

Press **FREQ** key and adjust center frequency with the data knob.

Press **SPAN** key and adjust frequency span with the step key.

Press **LEVEL** key and adjust carrier level with the data knob.

2

From the center frequency displayed, read carrier frequency  $f_c$ . Then, read carrier level  $E_c$  [dBm] (see Figure 5-21).

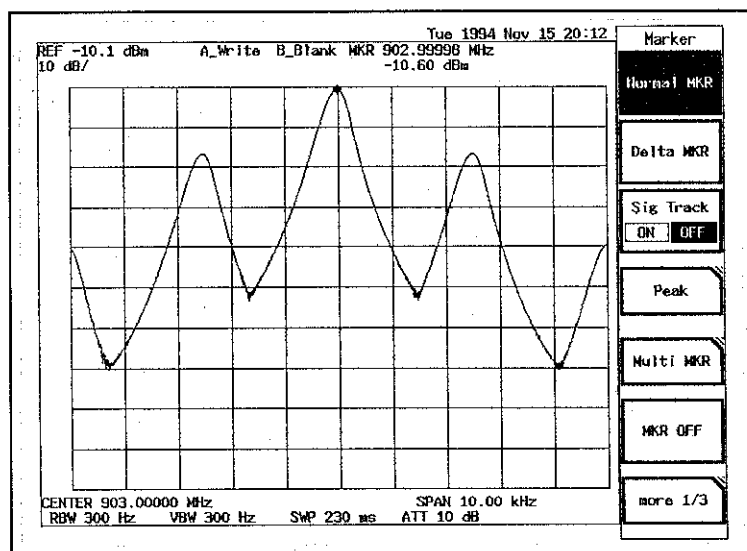

Figure 5-21  $f_c$  and  $E_c$  of FM wave

- 3 Press **MARKER ON** and **Peak** keys.
- 4 Press **more 1/2**, **return** and **Delta MKR** keys, and turn the data knob to move the delta marker on the 1st sideband wave, and read  $f_{SB}$  and  $E_{SB}$  [dBm] values from the displayed values for delta marker position (see Figure 5-22).

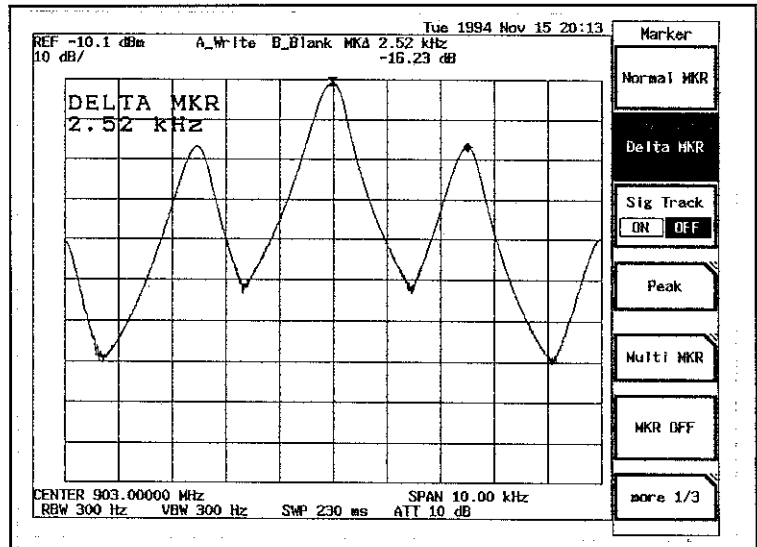

Figure 5-22  $f_{SB}$  and  $E_{SB}$  of FM wave

- 5 Calculate FM modulation index  $m$  using the following formula.

$$m = \log^{-1} \frac{E_{SB} - E_C + 6}{20}$$

- 6 Obtain modulation frequency  $f_m$  using the following formula or from the displayed frequency value for the delta marker position.

$$f_m = |f_{SB} - f_C|$$

- 7 Calculate frequency deviation  $\Delta f_{peak}$  using the following formula.

$$\Delta f_{peak} = m \times f_m$$

## 4. Measurement of Pulse Modulated Wave

The spectrum analyzer equivalently decomposes a wave to display higher harmonics and fundamental wave which are included in the signal. When a pulse modulated waveform displayed in time domain, as shown in Figure 5-23 (a), is converted to frequency domain, the spectrum which has an envelope with carrier frequency  $f_c$  at its center can be obtained, as shown in Figure 5-23 (b).

When a pulse modulated signal, such as a radar signal, is measured with the spectrum analyzer, the following items can easily be obtained.

- Pulse repetition frequency (PRF)
- Pulse width ( $\tau$ )
- Carrier frequency ( $f_c$ )
- Peak power ( $P_{peak}$ )
- Mean power ( $P_{ave}$ )

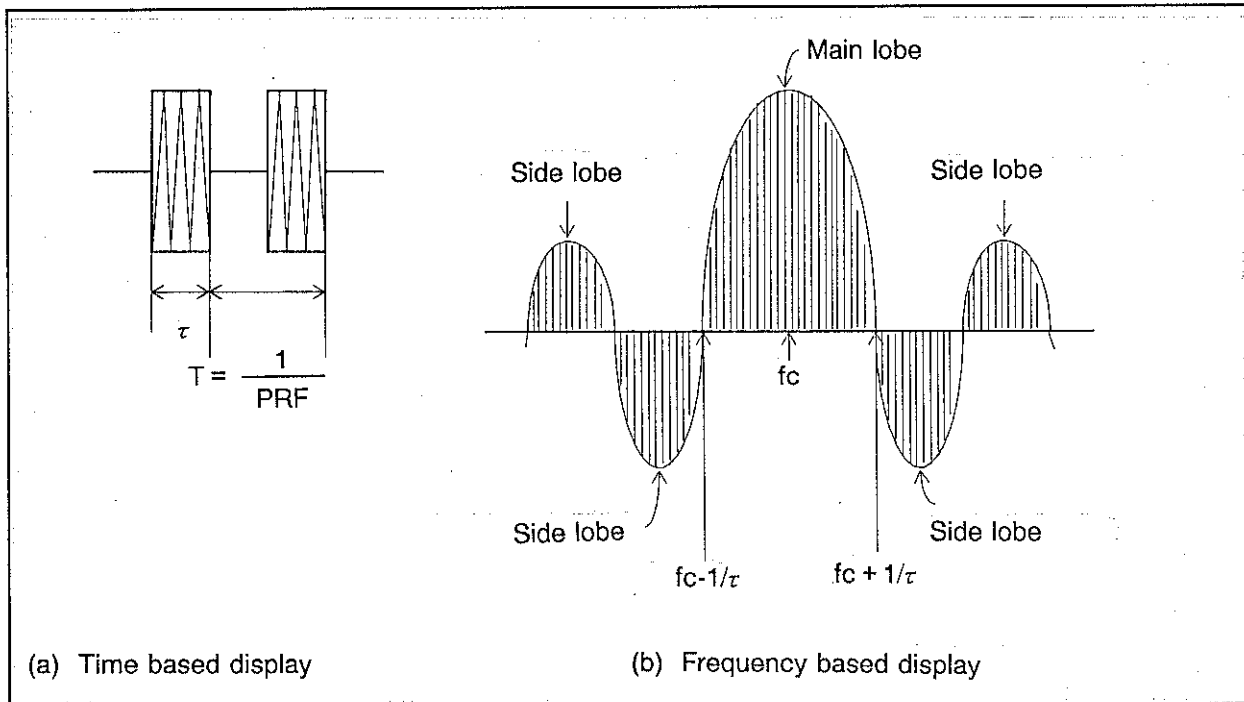

Figure 5-23 Pulse modulated wave

### CAUTION !

1. The maximum input level of this instrument is +30 dBm, 0 VDC when the input attenuator is set to 10 dB or more. Because pulse modulated wave such as radar wave tends to have a high peak power, be sure to sufficiently attenuate the signal with coupler or the like before inputting to the INPUT connector of this instrument.
2. Because the input level of the mixer of this instrument is -10 dBm, set the input attenuator so that  $P_{peak}$  does not become greater than -10 dBm. To avoid the mixer from saturating, set the input attenuator to the lowest value which does not cause signal level to decrease, by lowering the input attenuator value in units of 10 dB from 50 dB.



## ■ Pulse width ( $\tau$ )

Pulse width ( $\tau$ ) is the inverse number of 1/2 the main lobe width or of side lobe width. To obtain an envelope with sufficient resolution, it is necessary to set resolution bandwidth within the following range.

$$\text{Pulse repetition frequency (PRF)} = 1.7 \leq \text{Resolution bandwidth} \leq 0.1/\tau$$

## ■ Carrier frequency ( $f_c$ )

Measuring accuracy of carrier frequency ( $f_c$ ) depends on pulse width ( $\tau$ ). When  $\tau$  is small, main lobe becomes wide, making it difficult to find the center. To make the center clear, it is necessary to set SPAN/DIV to a wider value than  $1/\tau$ . Here, the accuracy of measured frequency is the accuracy of center frequency under set SPAN/DIV value.

## ■ Peak power ( $P_{\text{peak}}$ )

When resolution bandwidth of the spectrum analyzer satisfies the following conditions, displayed amplitude is proportional to resolution bandwidth.

$$\text{Pulse repetition frequency (PRF)} = 1.7 \leq \text{Resolution bandwidth} \leq 0.2/\tau$$

Here, displayed amplitude value is proportional to resolution bandwidth, and the relation between actual peak power  $P_{\text{peak}}$  (dBm) and displayed amplitude value  $P'_{\text{peak}}$  (dBm) is as follows.

$$\begin{aligned} P_{\text{peak}} &= P'_{\text{peak}} - \alpha \text{ (dB)} \\ \alpha \text{ (dB)} &= 20 \log (\tau \times 1.5 \times \text{RBW}) \quad \alpha: \text{Pulse attenuation factor} \end{aligned}$$

## ■ Mean power $P_{\text{ave}}$ (dBm)

Mean power  $P_{\text{ave}}$  (dBm) is calculated using the following formula.

$$P_{\text{ave}} = P_{\text{peak}} \times \text{PRF} \times \tau$$

PRF : Pulse repetition frequency (Hz)  
 $\tau$  : Pulse width (s)

## 5. Spectrum Analysis of Burst Signal

Gated sweep function enables spectrum analysis of burst signal.

### ■ Measuring method

Execute gate control with the gated sweep control (GATE IB) terminal on the rear of the instrument.

Sweep is started at "Hi" TTL level (or open) and stops at "Lo".

Input signal and gate control signal must conform to the following specifications.

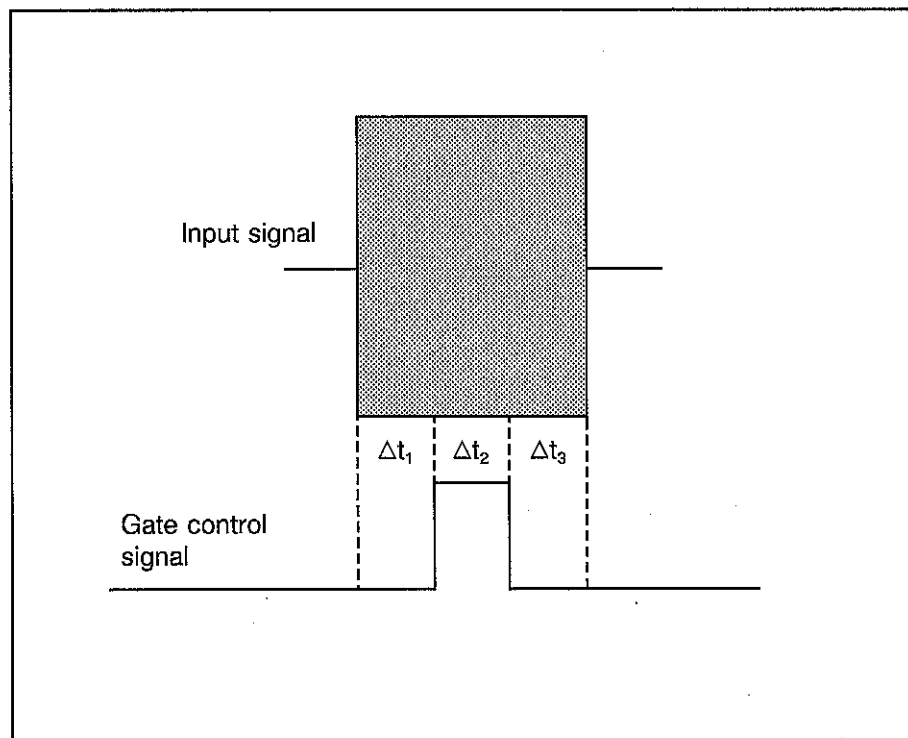

	RBW				
	5MHz to 1MHz	300kHz	100kHz	30kHz	10kHz
$\Delta t_1$	2 $\mu$ s or more	15 $\mu$ s or more	20 $\mu$ s or more	50 $\mu$ s or more	180 $\mu$ s or more
$\Delta t_2$	1 $\mu$ s or more				
$\Delta t_3$	15 $\mu$ s or more				

**NOTE**

To measure noise, select **SAMPLE** for detection mode.

## 6. How to measure transmitter test

### ■ Measurement of frequency error (modulation accuracy)

Input a signal fitting to communication systems (PDC, NADC, PHS) in INPUT connector.

1

Press .

2

Press  and set a communication type, a link,

etc. of the signal you want to measure with the data

knob and the step key.

Refer to page 7-81 for the details of set-up.

3

Press   and select the

measurement of frequency error.

4

Press  to set ON and set average times with

ten key.

5

Press  and set the center frequency of the

signal under measurement.

6

By pressing  or , the measurement is started.

## ■ Measurement of OBW (Occupied Bandwidth)

OBW is measured in 2 modes of TRANSIENT mode and CW mode. At the measurement in CW mode, RBW, VBW and Sweep Time can be set optionally, but at the measurement in TRANSIENT mode, only the measurement that fits to the standard can be performed.

### ● Measurement in TRANSIENT mode

- 1 Press TRANSIENT to set TRANSIENT mode.
  
  - 2 Press STD and set a communication type, a link, etc. of the signal you want to measure with the data knob and the step key.  
  
Refer to page 7-81 for the details of set-up.
  
  - 3 Press return Spectrum OBW to select OBW measurement.  
  
OBW/ACP/SP
  
  - 4 Press AVG Times and set average times with ten ON OFF key.
  
  - 5 Press FREQ and set the center frequency of the signal under measurement.
- 

6

By pressing **REPEAT** or **SINGLE** , the measurement is started.

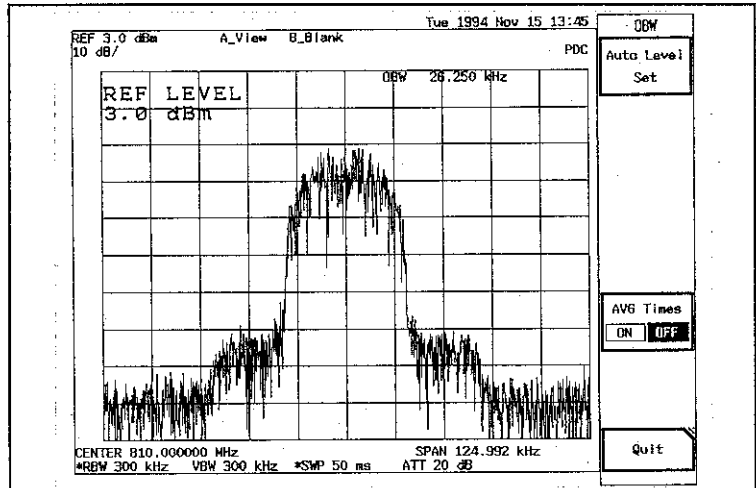

Figure 5-24 OBW measurement screen

● Measurement in CW mode

1

Press **FREQ** **Center** and set the center frequency of the signal under measurement.

2

Press **OBW** to display OBW measurement menu.

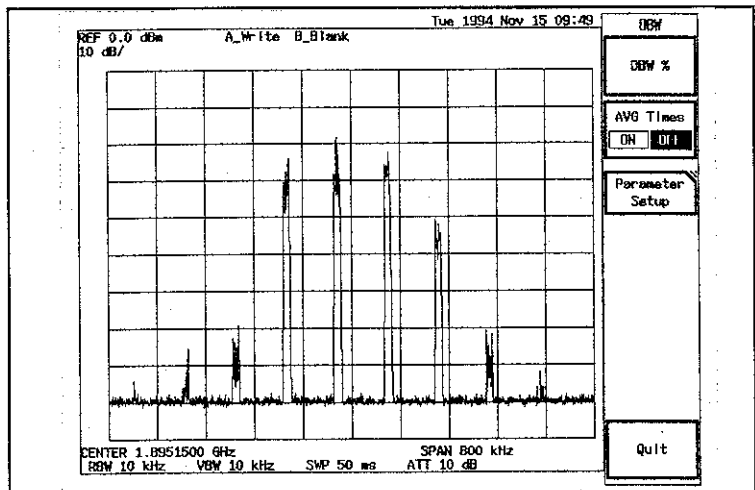

Figure 5-25 OBW measurement menu

3

Press **OBW %** and set the percent of whole energy to give definition with ten key.

4

Press **AVG Times** **ON** **OFF** and set average times with ten key



5

Press

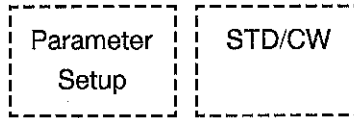

That sets communication types (PDC, PHS, STD OFF) which are set at .

By this setup, the measurement of RBW, VBW, Sweep Time, etc. are set automatically.

But the setup can be changed with  , .

6

Start measurement by pressing  or .

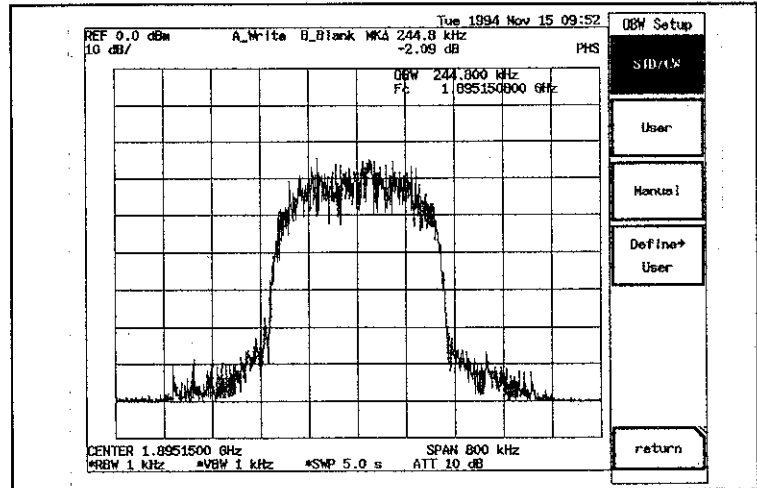

Figure 5-26 OBW measurement screen

## ■ Measurement of ACP (Adjacent Channel leakage Power)

ACP is measured in 2 modes of TRANSIENT mode and CW mode. At the measurement in CW mode, channel space and band width can be set optionally, but at the measurement in TRANSIENT mode, only the measurement that fits to the standard can be performed.

### ● High speed measurement in TRANSIENT mode

- 1 Press  to set TRANSIENT mode.
  - 2 Press  and set a communication type, a link, etc. of the signal you want to measure with the data knob and the step key.  
  
Refer to page 7-81 for the details of set-up.
  - 3 Press    to select APC measurement.  

return	Spectrum	ACP
	IOBW/ACP/SP	
  - 4 Press  and set average times with ten key.  

AVG Times
<input type="button" value="ON"/> <input type="button" value="OFF"/>
  - 5 Press  to set the center frequency of the signal under measurement.
- 



6

By pressing **REPEAT** or **SINGLE** , the measurement is started.

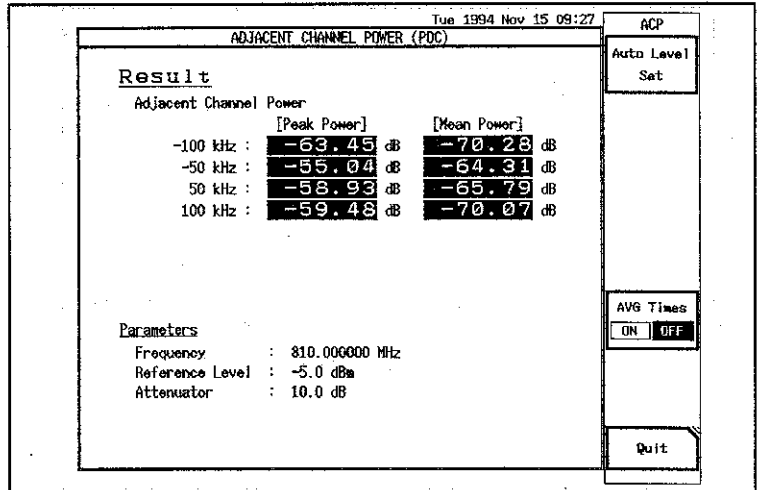

Figure 5-27 ACP measurement screen

● Measurement in CW mode

1 Press **FREQ** **Center** and set the center frequency of the signal under measurement with ten key, step key and data knob.

2 Press **ACP** to display ACP measurement menu.

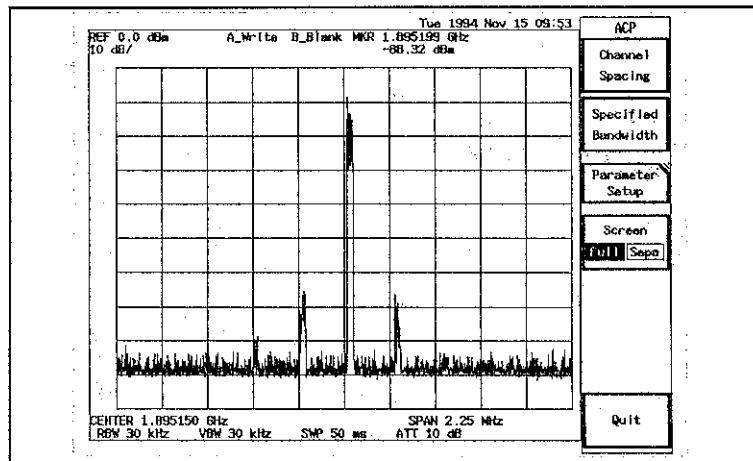

Figure 5-28 ACP measurement menu

3 Press **Parameter Setup** **STD/CW**.

That sets the communication types (PDC, PHS, STD OFF) which are set at **STD**.

By this setup, the measurement conditions of RBW, VBW, Sweep Time, Channel Spacing, Specified Bandwidth, etc. are set automatically.

But the setup can be changed with **SWEEP**, **SWP T**,

**Channel Spacing**, **Specified Bandwidth**.



4

Press return Screen and set the Full Sepa measurement method of carrier and adjacent channels.

Full : Full sweep measurement  
 Sepa : Separated sweep measurement

5

Start measurement by pressing REPEAT or SINGLE.

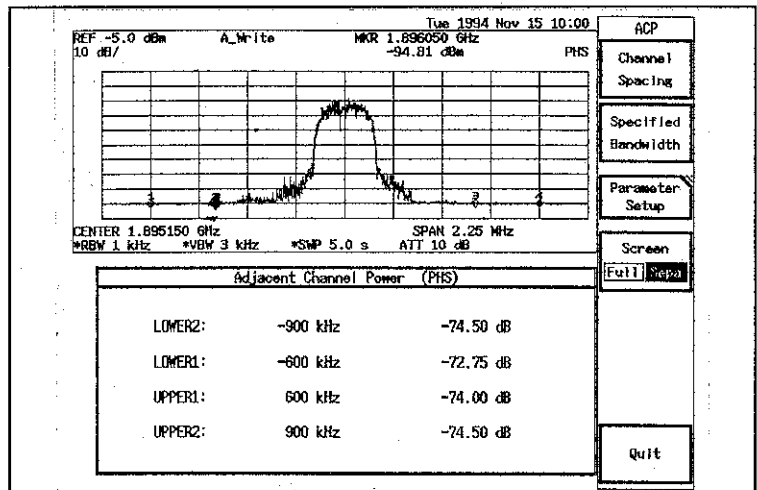

Figure 5-29 ACP measurement screen

### ■ Measurement of antenna power

- 1 Press **TRANSIENT** to set TRANSIENT mode.
- 2 Press **Power** **Antenna Power** to select the measurement of antenna power.
- 3 Press **AVG Times** **ON** **OFF** and set average times with ten key.
- 4 Press **FREQ** to set the communication channel or the center frequency of the signal under measurement.
- 5 By pressing **REPEAT** or **SINGLE**, the measurement is started.

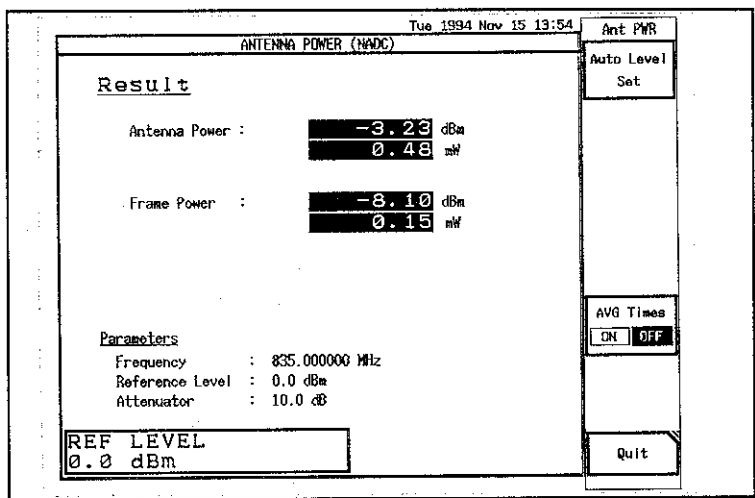

Figure 5-30 Antenna power measurement screen

## ■ Measurement of leakage power

Measure the leakage power at Carrier OFF.

1

Press **TRANSIENT** and **STD** to set a

communication type, a link, etc. of the signal you want to measure.

Refer to page 7-81 for the details of set-up.

### CAUTION !

*When the setup is combined as follows, the leakage power cannot be measured.*

Communication type	Link	Signal Type
PDC	DOWNLINK	—
NADC	DOWNLINK	—
PHS	—	Continuous

2

Press **return** **Power** **Carrier OFF** **Power** to

display leakage power measurement menu.

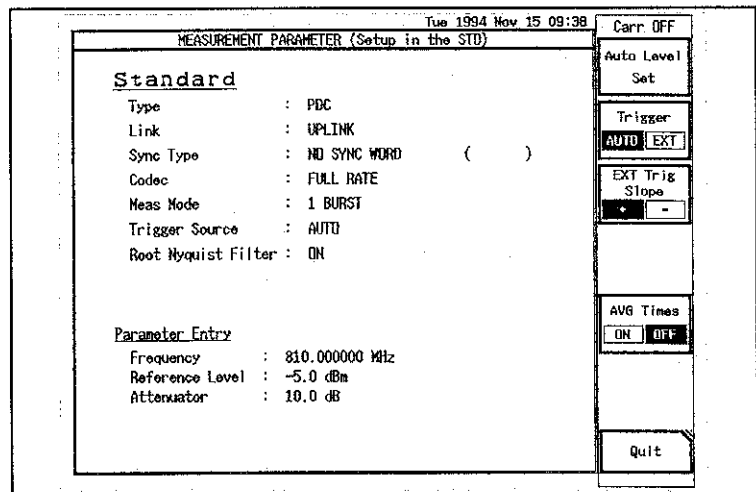

Figure 5-31 Leakage power measurement menu

6. How to measure transmitter test

3

Press **FREQ** and set the communication channel or the center frequency of the signal under measurement.

4

Press **AVG Times** and set the average times with ten key.

5

By pressing **REPEAT** or **SINGLE**, the measurement is started.

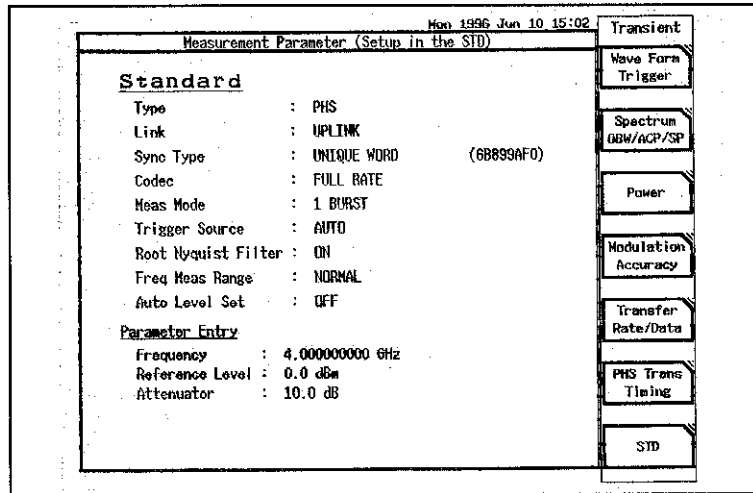

Figure 5-32 Leakage power measurement screen

**CAUTION !**

The measurement range of leakage power at Carrier OFF is under -30dBm.

■ Measurement of symbol rate

1 Press **TRANSIENT** to display TRANSIENT measurement menu.

2 Press **STD** and set a communication type or a link, etc. of the signal you want to measure.

Refer to page 7-81 for the details of set-up.

3 Press **return** **Transfer Rate/Data**

4 Press **AVG Times** and set average times with ten key.  
**ON** **OFF**

5 Press **FREQ** and set the communication channel or the center frequency of the signal under measurement.

6 By pressing **REPEAT** or **SINGLE**, the measurement is started.

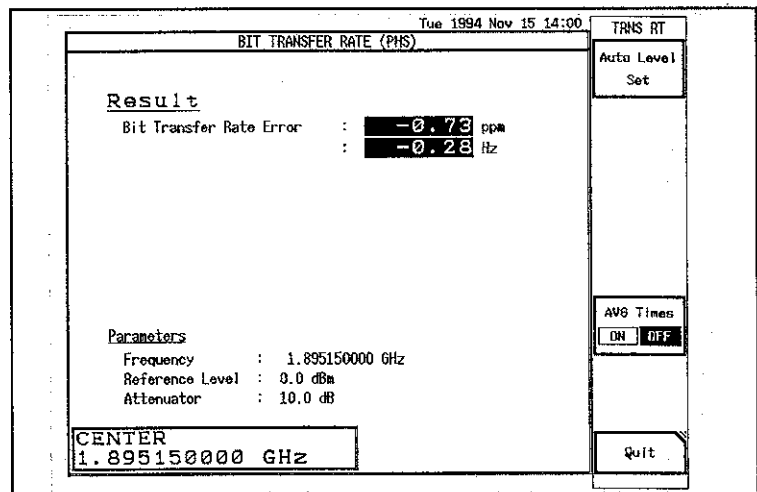
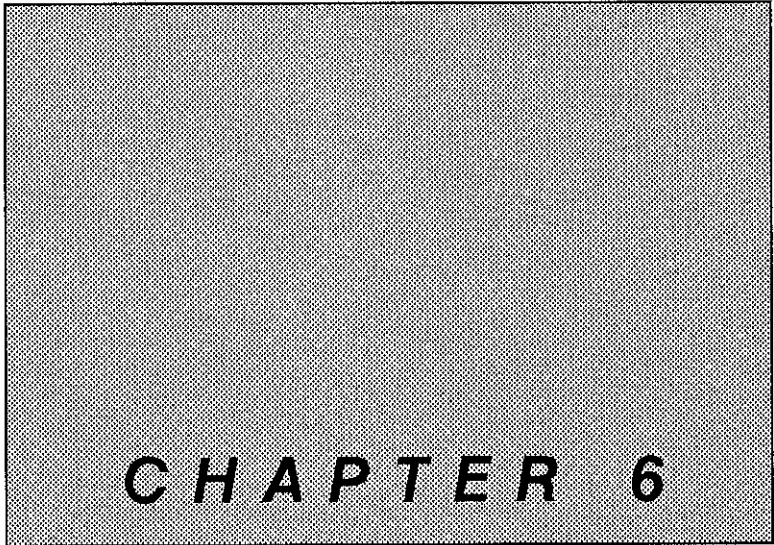

Figure 5-33 Symbol rate measurement screen







**CHAPTER 6**

**RECORD AND OUTPUT**

The record and output of the measurement data and the setting are described in this chapter.

---

**CONTENTS**

---

1. Record to the Memory Card .....	6-2
2. How to Output to the Printer .....	6-12
3. Output for Plotter .....	6-17
4. Output to the File .....	6-21
5. Setup for the Target Device of the Screen Data Output .....	6-24

---

## 1. Record to the Memory Card

The memory card is used in this instrument as the media in which the current set condition and the waveform data are stored. The features of the functions of the memory card are as follows:

- The memory card is adapted to the PC card guide line Ver 4.0 of the Japan Electronic Industry Development Association (JEIDA) or to PCMCIA Release 2.0 of the United States of America standards.
- There are two slot memory card drives and the two memory cards can be used simultaneously.

### ■ Usable Memory Card

- Adapted to JEIDA Ver.4.0 or higher ( 68 pin two piece connector).  
TYPE1
- Only the following Memory types are permitted.  
Common memory : SRAM  
Attribute memory : Any one of the SRAM, EPROM, MASKROM, EEPROM, OTPROM or flash memory is all right.
- Formatting  
MS-DOS format.  
Corresponding to the various kinds of memory size.

#### **CAUTION !**

*Only the memory cards that are adapted to the PC card guide line Ver 4.0 of the Japan Electronic Industry Development Association (JEIDA) or to PCMCIA Release 2.0 or higher of the United States of America standards are permitted. Use the memory cards only after making sure that those are adapted to the standards as above. See the page A-21 for further information.*

## ■ Memory Card Specifications

Table 6-1 Memory Card Specifications

Specifications	Memory Card
Connector	68 Pin two Piece Connector
Interface	In accordance with JEIDA Ver.4.0
Dimensions	54 (Width) × 86 (Length) × 3.3 (Thickness) mm
Operating Environment	No condensation Operating environment: 0 to 55°C Storage environment: -20 to 60°C Relative humidity: Less than 95%
Write protect	Switching ON and OFF by the switch. It is impossible to write if set to ON.

## ■ Contents of Storage to Memory Card

The followings are the contents that are able to be stored in the memory card.

- Set condition of the display screen
- The trace data and the table data

They are stored when each functions are set to ON and when they are

selected by Select  
Item.

- Trace data A,B
- Connection factor
- Limit line 1
- Limit line 2

1. Record to the Memory Card

■ **Note on Handling the Memory Card**

- Keep dust out from the hole of the connector.  
It causes defective contact or damage of the connector.
- Do not touch the connector with a material like a metal needle and so on.  
It may cause the static electricity destruction.
- Do not bend it or give a shock on it.
- Keep it away from water.

## ■ Insertion and Ejection of Memory Card

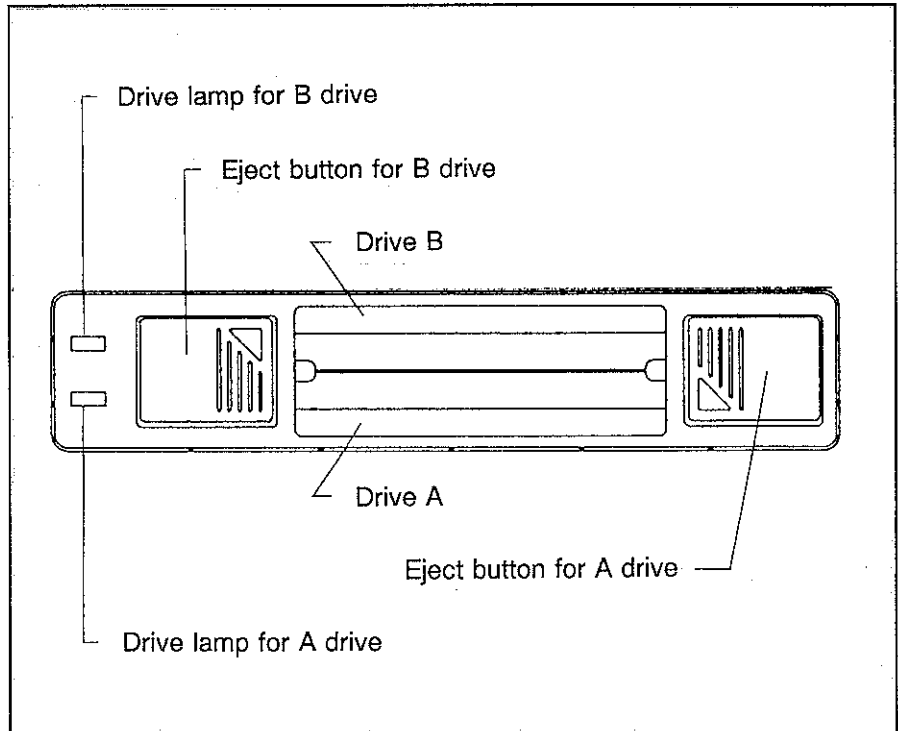

Figure 6-1 Drive Slot for Memory Card

The drive slots for the memory card are on the right upper side of the front panel.

1

**Insert the memory card with the printed side up.**

The drive lamp is turned on with yellow color when the memory card is inserted.

2

**When the memory card is ejected, press the eject button only after making sure that the drive lamp is turned on with yellow color.**

### **CAUTION !**

*The drive lamp is turned on with red color when the card is given access. Do not press the eject button to eject the memory card when the drive lamp is red.*

*In the case that the memory card is ejected when the drive lamp is red, the data in the memory card is not guaranteed.*

## ■ How to Initialize the Memory Card

Use the memory card that is not yet used only after initializing it.

**1** Turn the write protect of the memory card to the side of OFF.

### **WARNING !**

*Every data will be erased when the memory card that have the stored data is initialized again.*

**2** Insert the memory card.

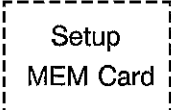
**3** Press  ,  and  to display

the software menu for selecting the card to be initialized.

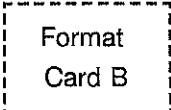
**4** Press  or  key to specify the

initializing of the card that is inserted into each drive.

When the dialog box is appeared on pressing each key, select "Confirm" by turning the data knob and press data knob to execute the initialization.

Confirmation	
Format Memory Card-A?	
<input type="button" value="Confirm"/>	<input type="button" value="Cancel"/>

In the case of not executing the initialization, select "Cancel" and press the data knob.

### **CAUTION !**

*The key operation on the panel is prohibited on executing the initialization.*

*The time that the initialization needs is different according to the capacity of the memory card, but at the end of the initialization the indication of "Confirmation" is disappeared. Furthermore, the memory card should not be ejected in executing the initialization.*

## How to Store into the Memory Card (Save Function)

### CAUTION !

- In the case that the data in the trace A or B is to be stored, set the trace mode in VIEW before execution. The waveform data cannot be stored in WRITE or BLANK mode.
- In the case that the prepared table data is to be stored, execute after setting the function in which that data is used in ON. "Select Item" is "Default" in both case of 1 and 2. Furthermore, each item can be selected optionally by "Select Item".

1

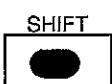
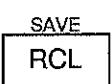
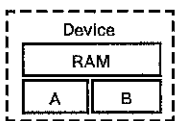
Press  ,  , and  and

specify the drive of the memory card.

The drive A is on the lower side and the drive B is on the upper side.

2

Press  key.

The screen shown in the Figure 6-2 is displayed.

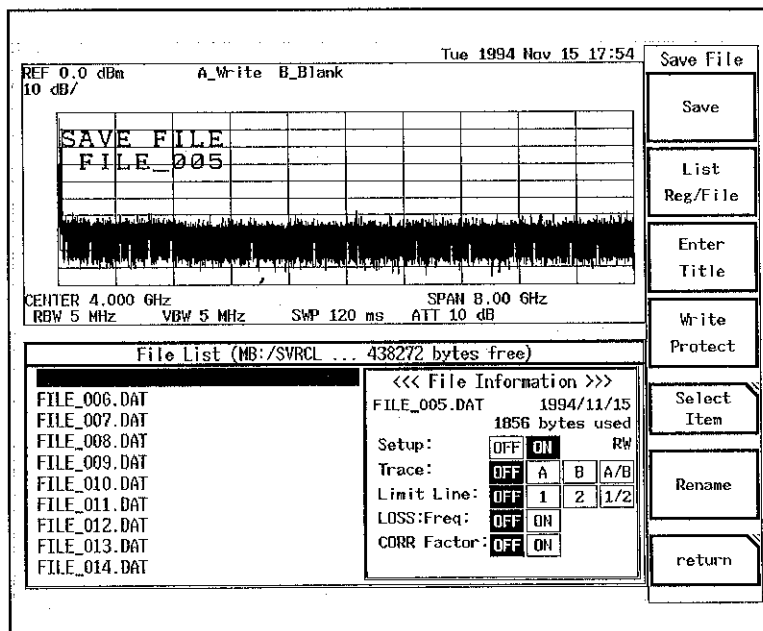

Figure 6-2 The Menu Screen of Save Function

1. Record to the Memory Card

3

Move the objective file by the step key or by the data knob to the position of the cursor to specify the file.

In the case of making a new file, move the last line of the file list to the specified cursor.

4

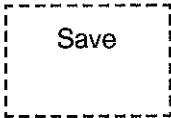
Press  to store the set condition into the memory card.

The file name is created automatically just on saving.



## How to Call from the Memory Card (Recall Function)

1

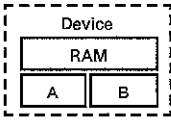
Press  and  to specify the drive of the memory card.

The drive A is on the lower side and the drive B is on the upper side.

2

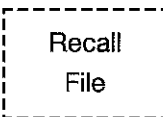
Press 

The screen shown in the Figure 6-3 is displayed.

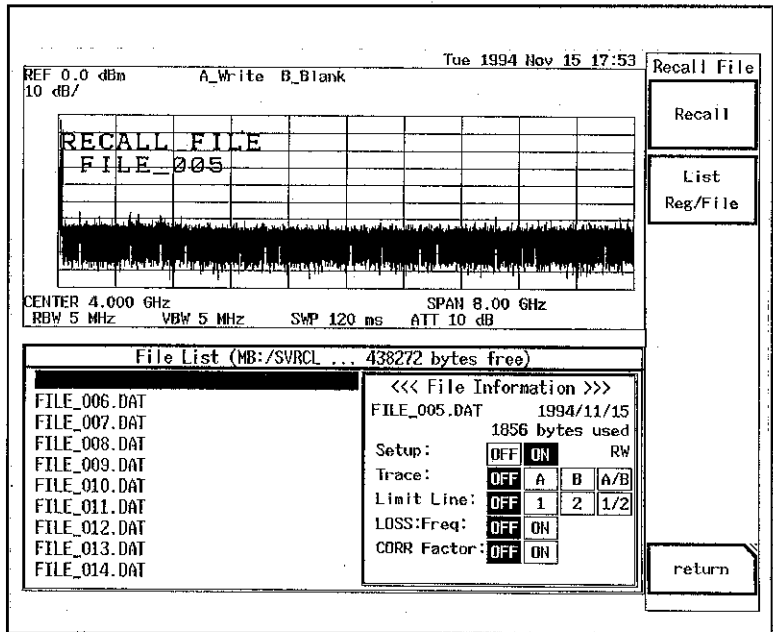
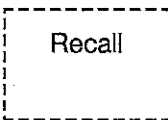

Figure 6-3 The Menu Screen of the Recall Function

3

Specify the file by the step key or by the data knob.

4

Press  to call the set condition of the specified file.

### CAUTION !

In the case of recalling only the data of the trace A or B, set trace in VIEW A or B before executing the recall.

1. Record to the Memory Card

## ■ Back Up of the Memory Card

### ● Life Span of the Back Up Battery

The SRAM card contains a battery. The life span of the battery depends on the static electrical current consumption.

The static electrical current consumption increases as the increase of the memory capacity and the life span of the battery is shortened as a result.

### **WARNING !**

*The life span of the battery is shortened when the memory card is left at the place in high temperature. Eject the memory card from the instrument when it is not used.*

### ● How to Back up the Memory Card

It is possible to back up the memory card (all copy) when exchanging the battery by using the two drive slots.

1

Insert the memory card to be backed up into the drive slot A and the memory card that has the same capacity to be copied all the data into the drive B.

2

Press the keys in order of  ,  ,

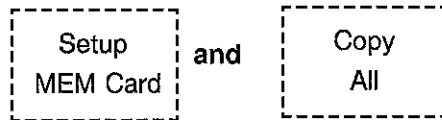

The following Confirmation message is displayed.

Confirmation	
Copy Memory-Card A to B?	
Confirm	Cancel



**3**

Select "Confirm" by the data knob or the step key and press the data knob to execute the all copy.

In case of not executing the all copy, press the data knob after selecting "Cancel".

**CAUTION !**

*It is impossible to copy all when the capacity of the memory is different.*

**● How to Exchange the Battery****CAUTION !**

*When exchanging the battery, all the data that is stored in the memory card is cleared off.*

*Exchange the battery after copying the necessary data to another memory card.*

The method of exchanging the battery of the memory card is different according to the manufacturer or the capacity of the memory card to be used.

Follow the process that is described in the user's manual of the memory card to be used to exchange the battery.

## 2. How to Output to the Printer

This instrument can output the screen data to the printer that is equipped with the parallel interface based on the centronics standards by using the PARALLEL port on the back panel (Graphic dump).

### **CAUTION !**

1. *Connect the cable after turning off the switch.*
2. *Depending on the kind of the printers to be used, there are some that does not begin the initial operation until the instrument is powered on.*
3. *The data that is output from this instrument is monochrome. It does not output in color even if it is connected with the printer corresponding to the color mode.*
4. *The resolution of output is 180Dot/inch. The stripes will appears when the printer with its solution is not the integral times of 180Dot/inch is used.*
5. *Check the control code of the printer to be connected. Then, set the corresponding code (ESC/P or HP PCL) to the analyzer.*
6. *The control code system for ESC/P J84 is different from that for ESC/P Raster.  
A printer compatible with ESC/P Raster cannot be used with the spectrum analyzer.*

### ■ Connectable Printer

This instrument adopts ESC/P (Epson Standards Cord for Printer) or HP PCL as the control code for the printer, so the printer corresponding to ESC/P or HP PCL is able to be connected.

The recommended printers that are able to be connected to this instrument is shown in the Table 6-2. Furthermore, the cable that connects the instrument with the printer should be the type designated by each manufacturer.

**Table 6-2 Recommended Printer**

Name of Manufacturer	Type Name
SEIKO EPSON	Mach Jet Printer series
Hewlett Packard	HP DeskJet505J Plus
Hewlett Packard	HP DeskJet500 series

## ■ Specification of the Output Form

The output form is monochrome data, but the printing mode is able to be selected from the three types shown in the Table 6-3.

**Table 6-3 Printer Output Format**

Type	Printing Mode		
Gray	Four gray scale	A4 full size	Landscape printing
Mono S	No gray scale	A4 half size	Portrait printing
Mono L	No gray scale	A4 full size	Landscape printing

1

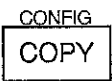
Press the keys in order of  ,  and

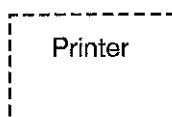

The following dialog box appears.

Printer			
Copy Mode :	<input type="button" value="Gray"/>	<input type="button" value="Mono S"/>	<input type="button" value="Mono L"/>
Printer Command :	<input type="button" value="ESC/P"/>	<input type="button" value="HP PCL"/>	
Memu Print :	<input type="button" value="ON"/>	<input type="button" value="OFF"/>	

2

Select one of "Gray/Mono S/Mono L" by turning the data knob and press the data knob to specify.

The printing examples in each printing modes are shown in the Figure 6-4, the Figure 6-5 and the Figure 6-6.

3

Select ESC/P or HP PCL depending on the control command of the output printer, then press the data knob to set that.

4

Select ON if soft menu is necessary for the output, if not then select OFF.

### **CAUTION !**

If the power is turned off after the setting is changed and the dialog box is still being displayed, the setting is ignored.

2. How to Output to the Printer

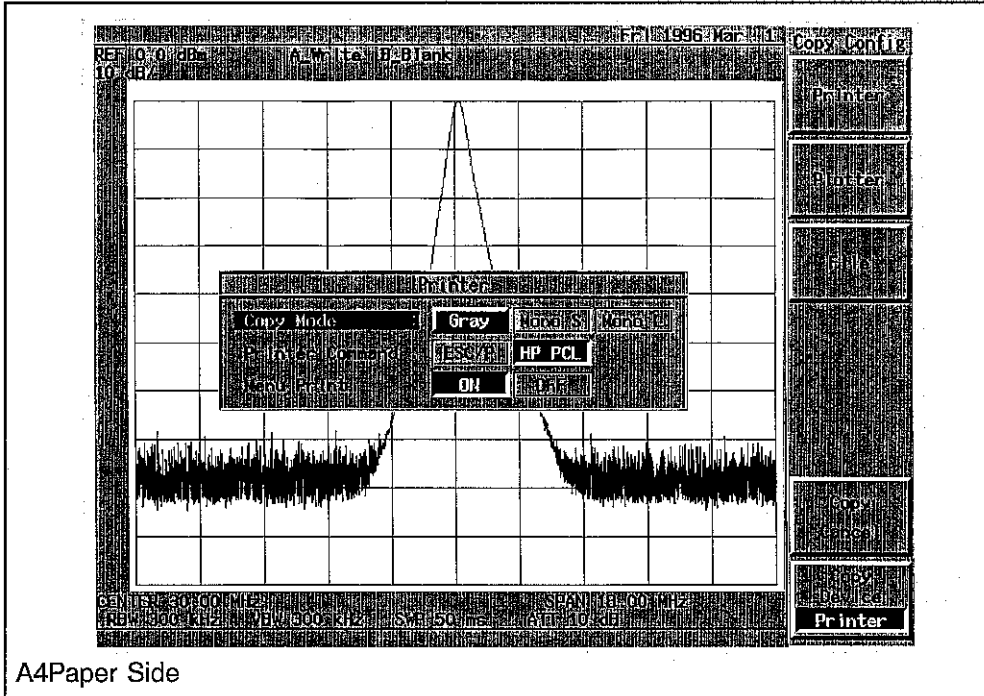

A4Paper Side

Figure 6-4 Printing Example in the Printing Mode "Gray"

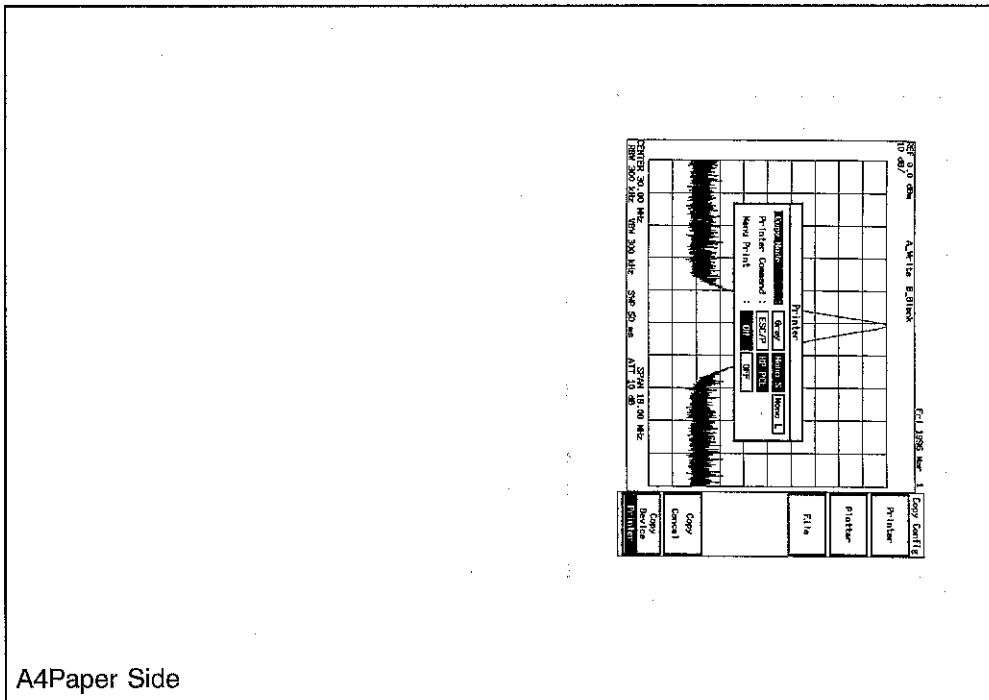

A4Paper Side

Figure 6-5 Printing Example in the Printing Mode "Mono S"

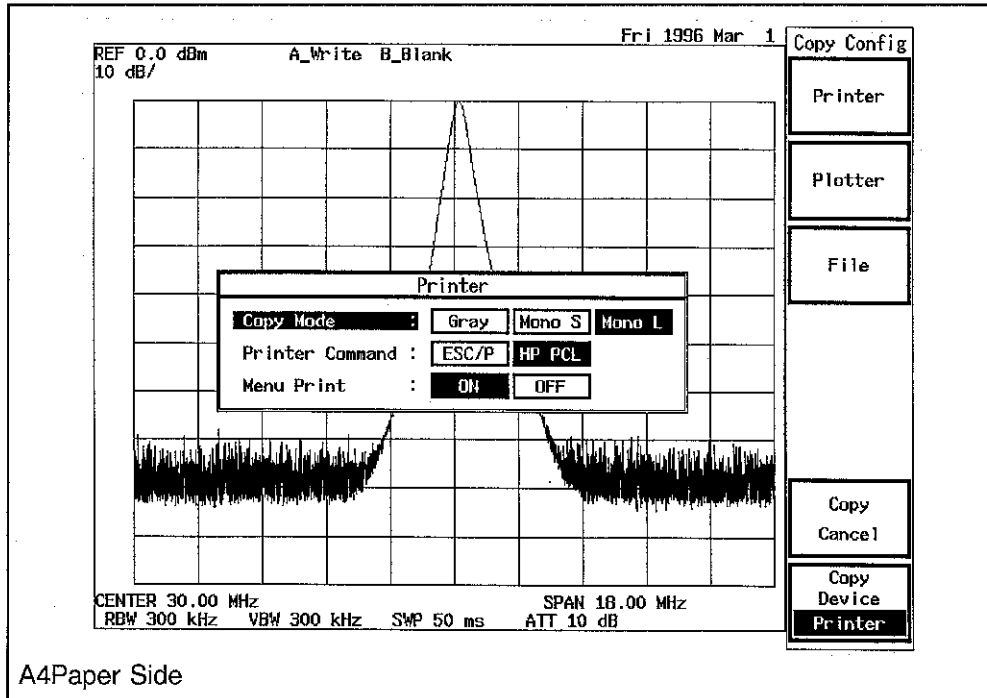

Figure 6-6 Printing Example in the Printing Mode "Mono L"

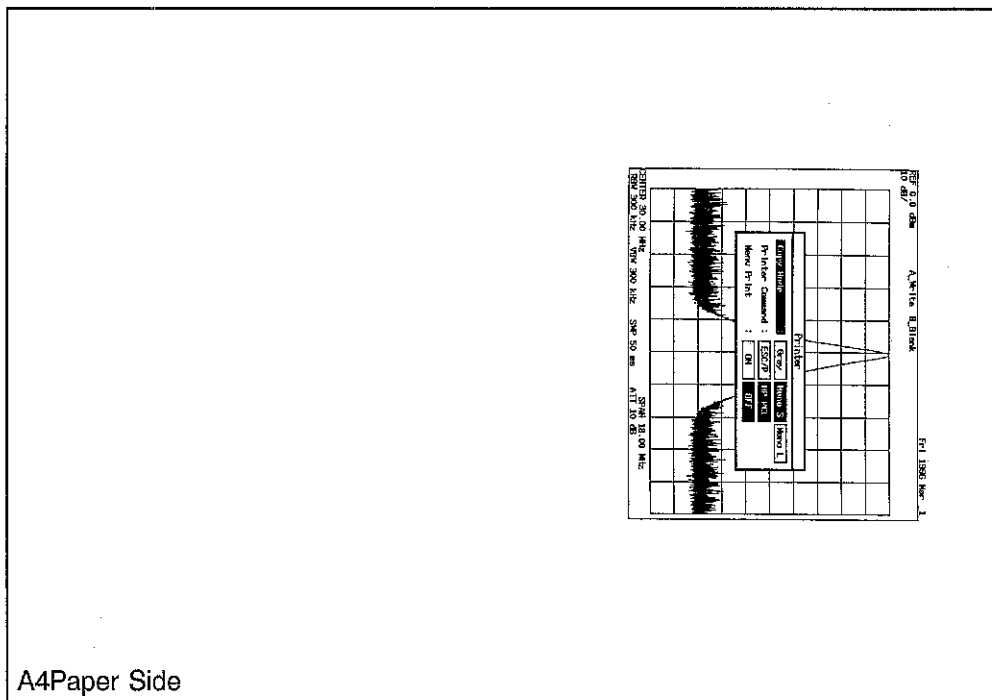

Figure 6-7 Printing Example in the Menu Print "OFF"

## ■ Output to the Printer

The output to the printer is started on pressing the "COPY" key. The output data is the data that is displayed just when the "COPY" key is pressed. It is possible to operate the panel keys after starting the output. (It does not need to wait the end of printing.) And the output data is not affected by operating the panel keys in printing.

### **CAUTION !**

- 1. It needs about one minute for printing. (It is different according to the printer to be used and the printing mode.)*
- 2. The printing demand is ignored even if the "COPY" key is pressed again in printing.*



### 3. Output for Plotter

The screen data can be output to a plotter is adapted the HP-GL which is communicated by GP-IB interface of the Spectrum Analyzer.

#### **CAUTION !**

1. *Connect GP-IB cable after AC power turned off.*
2. *Read the manual of the plotter to be used.*
3. *Dialog box, list display (Multi-marker list and other), characters only display Measurement parameter set and other) and graphic display (Graphics of the modulation analysis and other) cannot be plotted.*

#### ■ Available plotter

The Spectrum Analyzer becomes available to interface the plotter is adapted the control command set of HP-GL (Hewlett-Packard Graphics language).

However, GP-IB interface is not strictly for the interface standards, therefore, it is necessary to check the actual interface operation. Listed plotters in the following table checked for the operation by ADVANTEST.

**Table 6-4 Operation tested plotters by ADVANTEST**

Manufacturers	Model name
ADVANTEST	R9833
Hitachi Denshi	682-XA (Note) Set all of 4 pens to the pen slot.
Hewlett Packard	HP7470A, HP7440A, HP7475A and HP7550A.

#### ■ Setup for the plotter

Setup listen only or 0 to 30 for the plotter address.

Some plotters need more setup in addition to the setup of the address, if it is necessary then read manual for details.

Set A4 size paper in landscape orientation on the platter.

**■ Setup for the plot format**

1

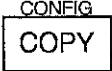
Press the key in order of ,  and



Following dialog box is displayed.

Plotter	
Copy Mode :	<input type="button" value="ALL"/> <input type="button" value="TRACE"/>
Division :	<input type="button" value="1"/> <input type="button" value="2"/> <input type="button" value="4"/>
Locate Mode :	<input type="button" value="AUTO"/> <input type="button" value="MANUAL"/>
Location :	<input type="button" value="UpLeft"/> <input type="button" value="UpRight"/> <input type="button" value="LowLeft"/> <input type="button" value="LowRight"/>
GPIB Mode :	<input type="button" value="TALK ONLY"/> <input type="button" value="ADDRESSABLE"/>
Plotter Address :	<input type="text"/>

2

Rotate data knob, select desired item and set it by pressing the data knob.

Copy Mode: ALL ; All of the data on the screen is plotted.  
TRACE; Only wave form on the screen is plotted.

Division : 1 ; The plot is carried out to the full size of the paper.  
2 ; The plot is carried out on the two part split size.  
4 ; The plot is carried out on the four part split size.

Locate Mode : AUTO ; Location can be moved automatically.  
At the two part split size.  
Left→Right→Left  
At the four part split size.  
UpLeft→UpRight→LowLeft→  
LowRight→UpLeft





MANUAL ; Location cannot be moved automatically.

Location : Plot is set for the split plot.

GPIB Mode : TALK ONLY ;Talk only mode is set.

ADDRESSABLE ; Addressable mode is set.

Plotter Address : When addressable mode is set for the Spectrum Analyzer, specify the address of the connected plotter.  
Moreover, also specify the same address for the connected plotter.

## ■ Output to the plotter

Press COPY key then output to the plotter is started.

The output data is the data of the display at the time when COPY key is pressed.

Operation of the panel key is available after output is started.

(it is not necessary to wait after the completion of plot.)

Even if the panel key is pressed during plotting, but the output data in not change.

### **Note**

*Even if COPY key is pressed again during plotting but this plot requirement is omitted.*

## ■ Cancel for the plot output

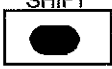
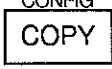
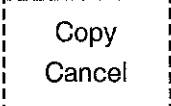
If the key in order of  ,  and  are pressed then plot output is canceled.

Plotter are pressed then plot output is canceled.

However, if the plotter has the buffer memory then the stored data in the buffer memory is plotted.

3. Output for Plotter

**Table 6-5 Plotter paper size**

Plotter model	Paper size
HP7470A	A4 (ISO A4)
HP7440A	A4 (ISO A4)
HP7475A	MET A4 (ISO A4)
HP7550A	MET A4 (ISO A4)
R9833	A4 Landscape

**Table 6-6 Assignment of the plotter pen**

Pen number	Paper size
Pen 1	Frame
Pen 2	Marker and characters
Pen 3	Trace A
Pen 4	Trace B
Pen 5	Display line
Pen 6	
Pen 7	Windows
Pen 8	Limit line

## 4. Output to the File

The screen data can be output to the memory card in the bit map file format which is adapted by Microsoft Windows.

### **CAUTION !**

*Drive lamp indicates the red color during accessing for the memory card.*

*Do not eject the memory card during drive lamp indicates the red color.*

*If the memory card is ejected during drive lamp indicates the red color then the data in the card does not ensure.*

### ■ Specifying the data output

1

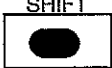
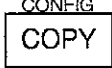
Press the keys in order of  ,  and

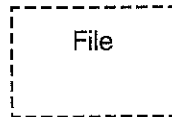

Following dialog box is displayed.

File	
File Format :	<input type="text" value="BMP"/>
Copy Mode :	<input type="text" value="Color"/> <input type="text" value="Gray"/> <input type="text" value="Mono"/>
Compression :	<input type="text" value="OFF"/> <input type="text" value="ON"/>
File No. :	<input type="text" value="001"/> Filename: \IMGVADV001. BMP
Auto Increment :	<input type="text" value="OFF"/> <input type="text" value="ON"/>

2

Select desired item by step key and set the data by keypad or knob.

Copy Mode : Color ; Color bit map data is output.  
 Gray ; Bit map data of monochrome with 4-step gradation is output.  
 Mono ; Bit map data of monochrome without gradation is output.

### **CAUTION !**

*No color printout is obtained from the bitmap data even if Color mode is selected with the screen display mode set to Gray or Mono.*

4. Output to the File

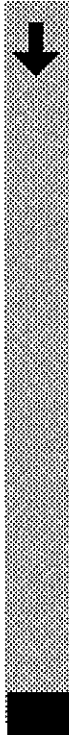

Compression : OFF ; Bit map data is not compressed and is output.  
 ON ; Bit map data is compressed and is output.

**CAUTION !**  
*If the compressed bit map data is displayed using by the graphic view of the application software on the personal computer then it needs to have decompression function. Some application software does not support for the compressed bit map data. In this case, use non-compressed bit map data.*

File No. : Number (3-digit) of the file to be output is set.  
 File is output by the file name which is displayed at the right-side of the set number.

Auto Increment : OFF ; File number is not updated.  
 ON ; File number is updated automatically.

■ Output to the file

When the data is output to the A or B drive, press COPY key then it is started.  
 The output data is the display at the time when COPY key is pressed.  
 Operation of the panel key is available after output is started.  
 (it is not necessary to wait after the completion of output.)  
 Even if the panel key is pressed during outputting, but the output data is not change.

**Note**  
*Even if COPY key is pressed again during outputting but this output is omitted.*

File is output to the /IMG directory in the selected drive and the file name is ADVxxx with extensions (xxx is a file name).  
 The /IMG directory is created automatically.  
 Extensions of output file is shown in the following table.

Table 6-7 File extension

Compression	Extensions
OFF	.BMP
ON	.RLE

### ■ Cancel for the file output

If the key in order of

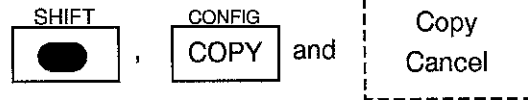

then file output is canceled.

### ■ File size

Screen data in the bit map file is output then the file size becomes as shown following table.

Table 6-8 Output File Size

Copy Mode	Compression	File size (kbytes)
Color	OFF	300
	ON	30 to 70
Gray	OFF	150
	ON	30 to 70
Mono	OFF	38

#### **CAUTION !**

*File size of compression ON exceeds the values in the above table because of the compressed files size vary by displayed data.*

## 5. Setup for the Target Device of the Screen Data Output

Printer, plotter and memory card can be selected for the target device of the screen data output. Setup of the target device.

### ■ Setup of the target device

1

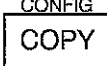
Press the key in order of ,  and

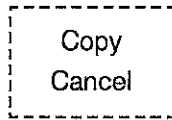

Following dialog box is displayed.

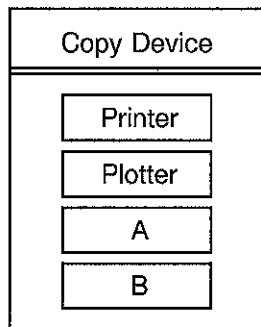

2

Select desired item by data knob and press the data knob for setup.

Printer : The data is output to the printer.

Plotter : The data is output to the plotter.

A : The data is output to the memory card of A drive.

B : The data is output to the memory card of B drive.



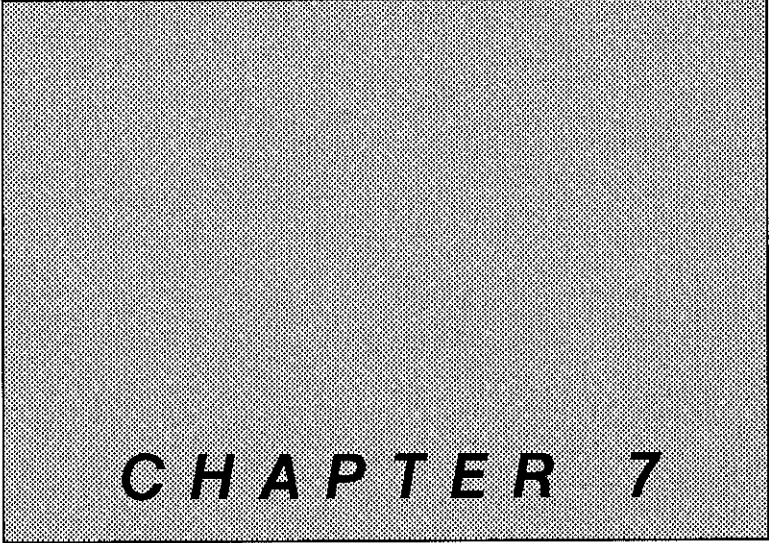

**CHAPTER 7**

**FUNCTION DESCRIPTIONS**

This chapter explains basic and applied functions. For menu list, see Section A.3.

---

**CONTENTS**

---

- 1. Functions of Fundamental Keys ..... 7-2
- 2. Functions of FORMAT Mode ..... 7-17
- 3. Functions of MARKER Section ..... 7-29
- 4. Functions of SWEEP Mode ..... 7-42
- 5. Functions of MEASUREMENT Section . 7-49
- 6. Save Function ..... 7-85
- 7. Recall Function ..... 7-93
- 8. Calibration Function ..... 7-96
- 9. System Functions ..... 7-99
- 10. Window Function ..... 7-101

---

# 1. Functions of Fundamental Keys

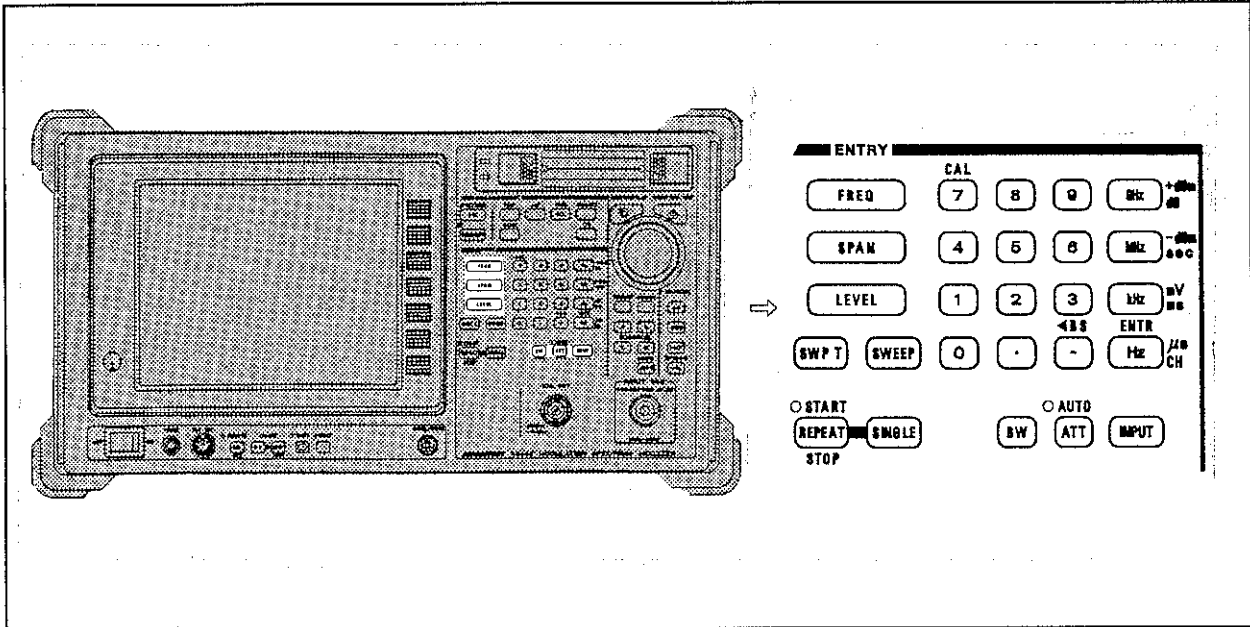

Figure 7-1 Functions of Fundamental Keys on the Front Panel

## Center Frequency

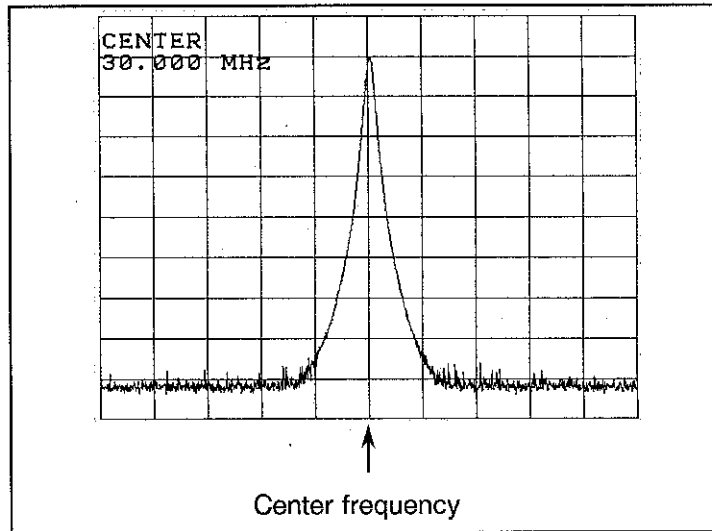
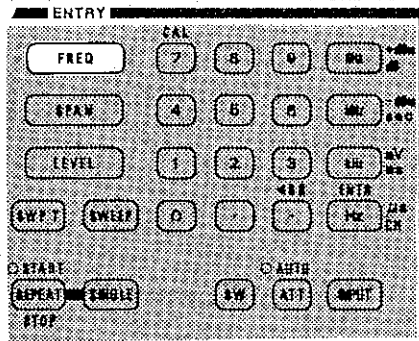

Figure 7-2 Center Frequency Display

**FREQ**

Sets the center frequency setting mode. Pressing this key enables data entry and displays center frequency data on the screen.

Frequency range  
 R3463 : 0 to 3.0 GHz  
 R3465 : 0 to 8.0 GHz

**Table 7-1 Display Resolution of Center Frequency**

Display Resolution of Center Frequency			
1 MHz		Span	≧ 1000 MHz
100 kHz	1000 MHz >	Span	≧ 100 MHz
10 kHz	100 MHz >	Span	≧ 10 MHz
1 kHz	10 MHz >	Span	≧ 1 MHz
100 Hz	1 MHz >	Span	≧ 100 kHz
10 Hz	100 kHz >	Span	≧ 10 kHz
1 Hz	10 kHz >	Span	≧ 2 kHz
1 Hz		Span	= 0 Hz

**Note**  
 Higher resolutions are rounded off in the displayed.

● Explanation of Center Frequency Menu

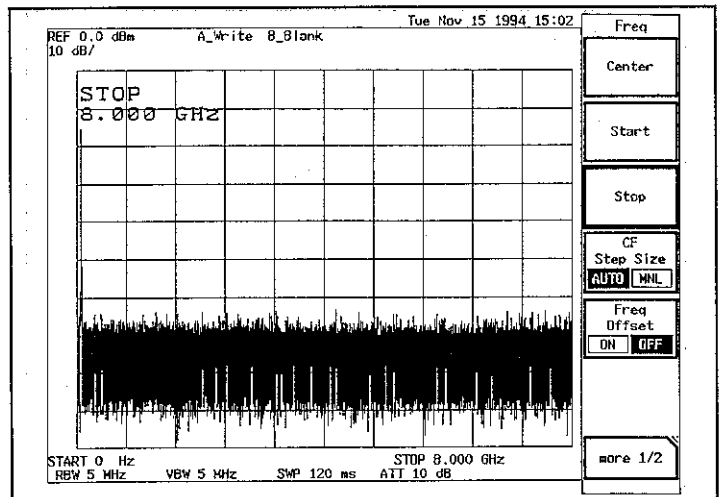
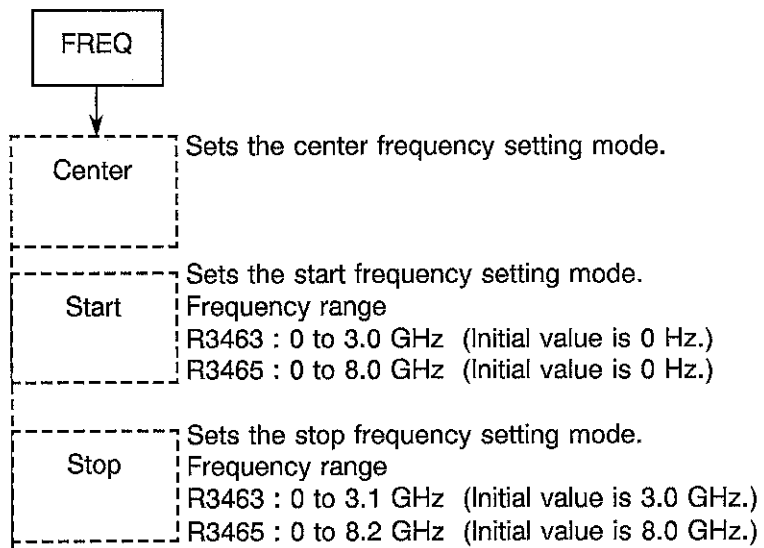

**Figure 7-3 Start/Stop Frequency**

1. Functions of Fundamental Keys

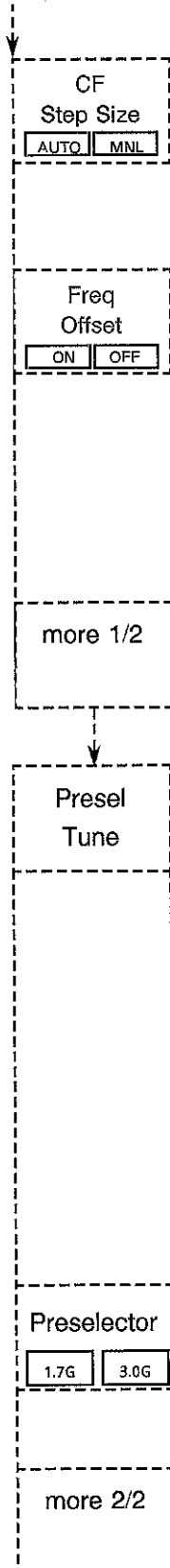

When MANUAL is selected, step size of the center frequency can be set. In MANUAL, data can be entered and the step size data of the center frequency is displayed on the screen. In AUTO, the step size is set to 1/10 of the frequency span.

When ON is selected, an offset frequency can be set in the range of 0 to ±100,000 MHz. If a value less than the display resolution is entered, it will be replaced with the value of the display resolution.

<p>Center frequency (displayed) = Center frequency (set) + Offset</p>
---

When OFF is selected, the offset is canceled.

Displays menu on the following page. (Only R3465)  
This menu item is not provided to R3463.

Adjusts a tracking between the sweep frequency of the preselector embedded in the input part and the sweep input frequency in the input frequency range of 1.7 to 8.2 GHz.

When the base band frequency (0 to 1.7 GHz or 0 to 3.0 GHz) is in the set frequency range, this function does not operate. And neither in EXT MIXER.

AUTO Peeking

Automatically adjusts the tracking of the preselector so that the signal level indicated by a marker is maximum. Use this function after positioning a marker near the peak of a desired input signal.

Manual Peeking

It is possible to adjust the tracking of the preselector manually (with ten keys, a data knob and step keys).

Switches the value of lower limit frequency which operates preselector.

If 1.7G is selected, the preselector can be used from 1.7GHz, and if 3.0G is selected, it can be used from 3.0GHz. The initial value is 1.7G.

Returns to the menu on the previous page.

**Frequency Span**

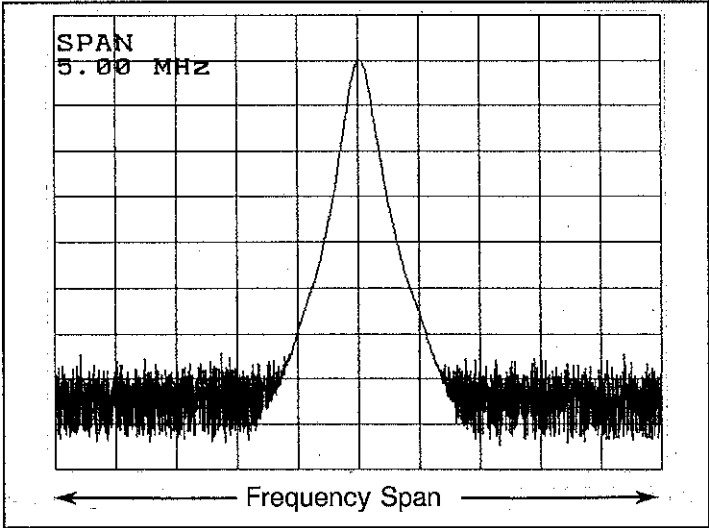
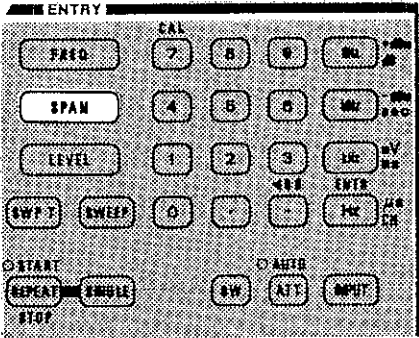

Figure 7-4 Frequency Span

**SPAN**

Sets the frequency span setting mode. In this mode, data can be entered and frequency span data is displayed on the screen.

Table 7-2 Display Resolution of Frequency Span

Display Resolution of frequency span	
10 MHz	Span > 4000 MHz
1 MHz	4000 MHz $\cong$ Span > 400 MHz
100 kHz	400.0 MHz $\cong$ Span > 40.1 MHz
10 kHz	40.00 MHz $\cong$ Span > 2.01 MHz
1 kHz	2.000 MHz $\cong$ Span > 401 kHz
100 Hz	400.0 kHz $\cong$ Span > 20.0 kHz
10 Hz	20.00 kHz $\cong$ Span > 2.00 kHz
1 Hz	2.000 kHz = Span

● Explanation of Frequency Span Menu

SPAN



Full Span

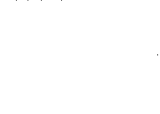

Zero Span

R3463:  
Automatically sets the 1.5 GHz center frequency and the 3 GHz span.

R3465:  
Automatically sets the 4 GHz center frequency and the 8 GHz span.

The frequency is fixed to the center frequency. The analyzer operates as a tuned receiver. The horizontal axis becomes a time axis. The center frequency resolution is determined according to the set resolution bandwidth.

## Reference Level

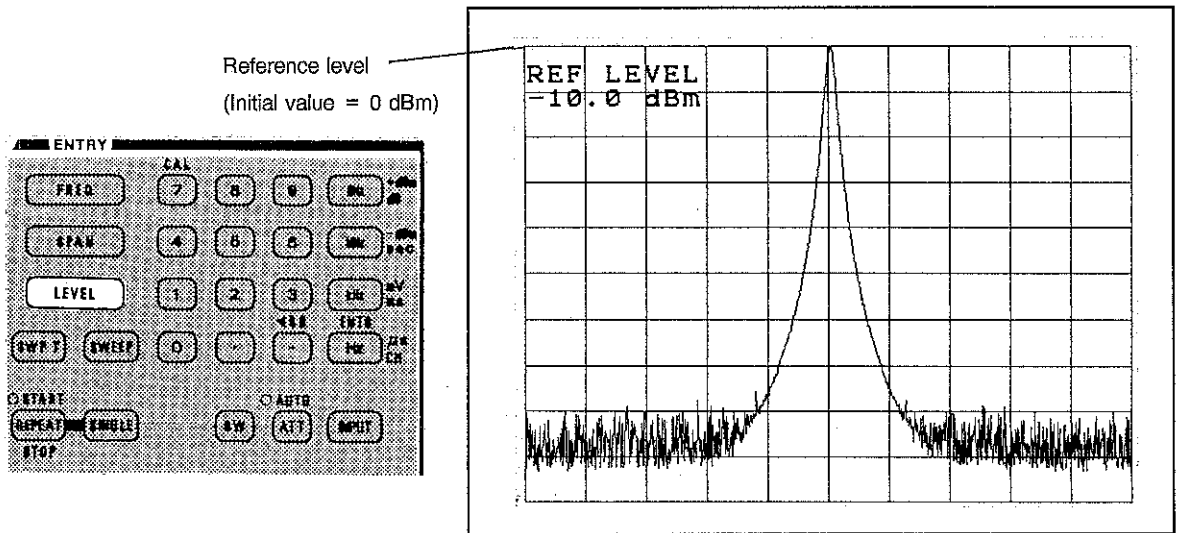
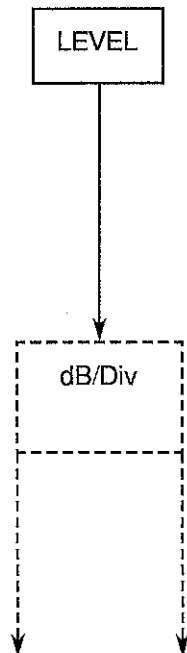

Figure 7-5 Reference Level

### Explanation of Reference Level Menu



Reference level can be set in the range of -105 dBm to +60 dBm.

#### **CAUTION!**

*The reference level is restricted by the input attenuator that is in MANUAL or by the setting value of Min ATT and its setting range may be narrower than the range from -105dBm to +60dBm.*

The vertical amplitude scale can be set from 10 dB/div to 0.5 dB/div.

1. Functions of Fundamental Keys

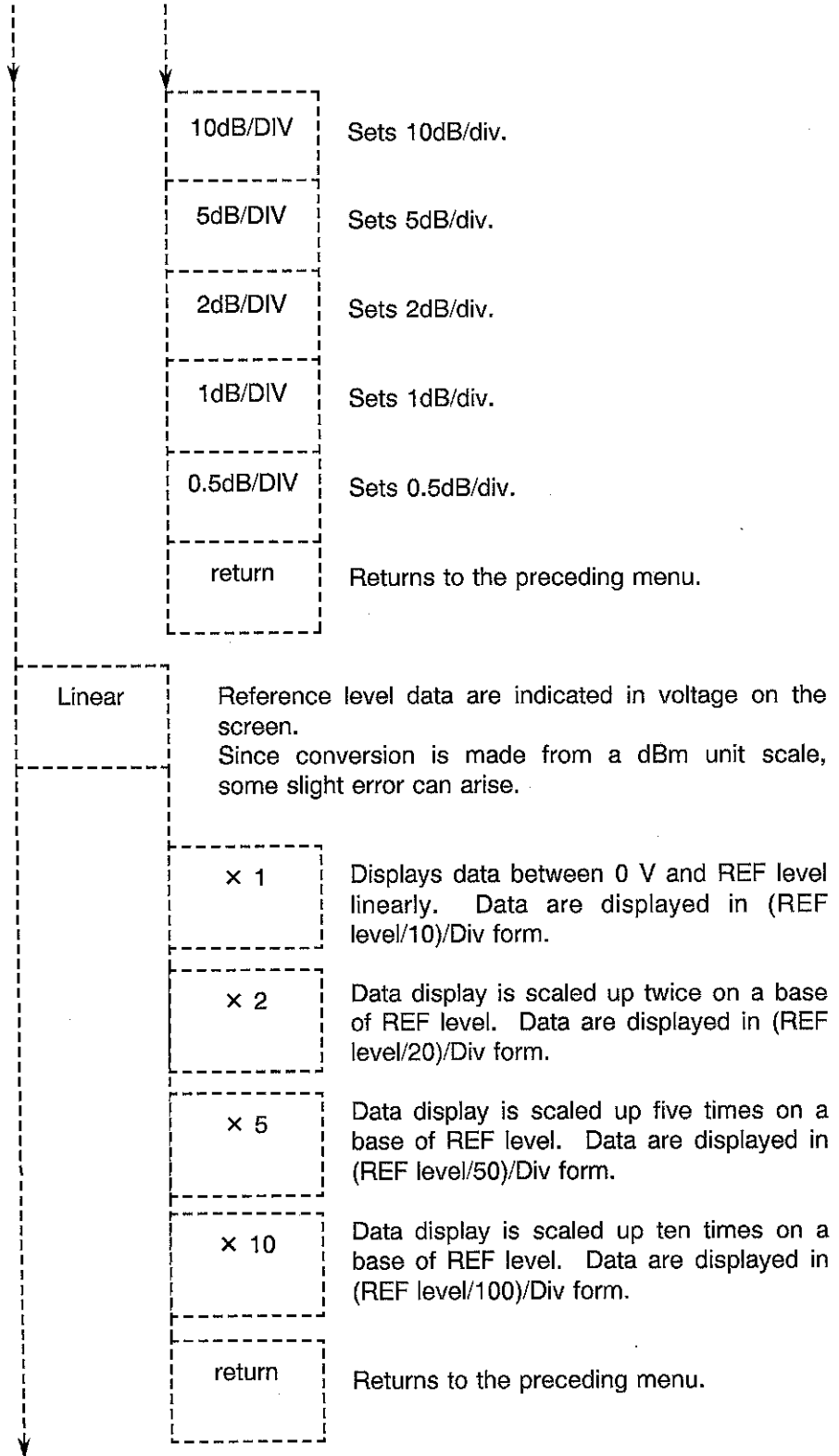



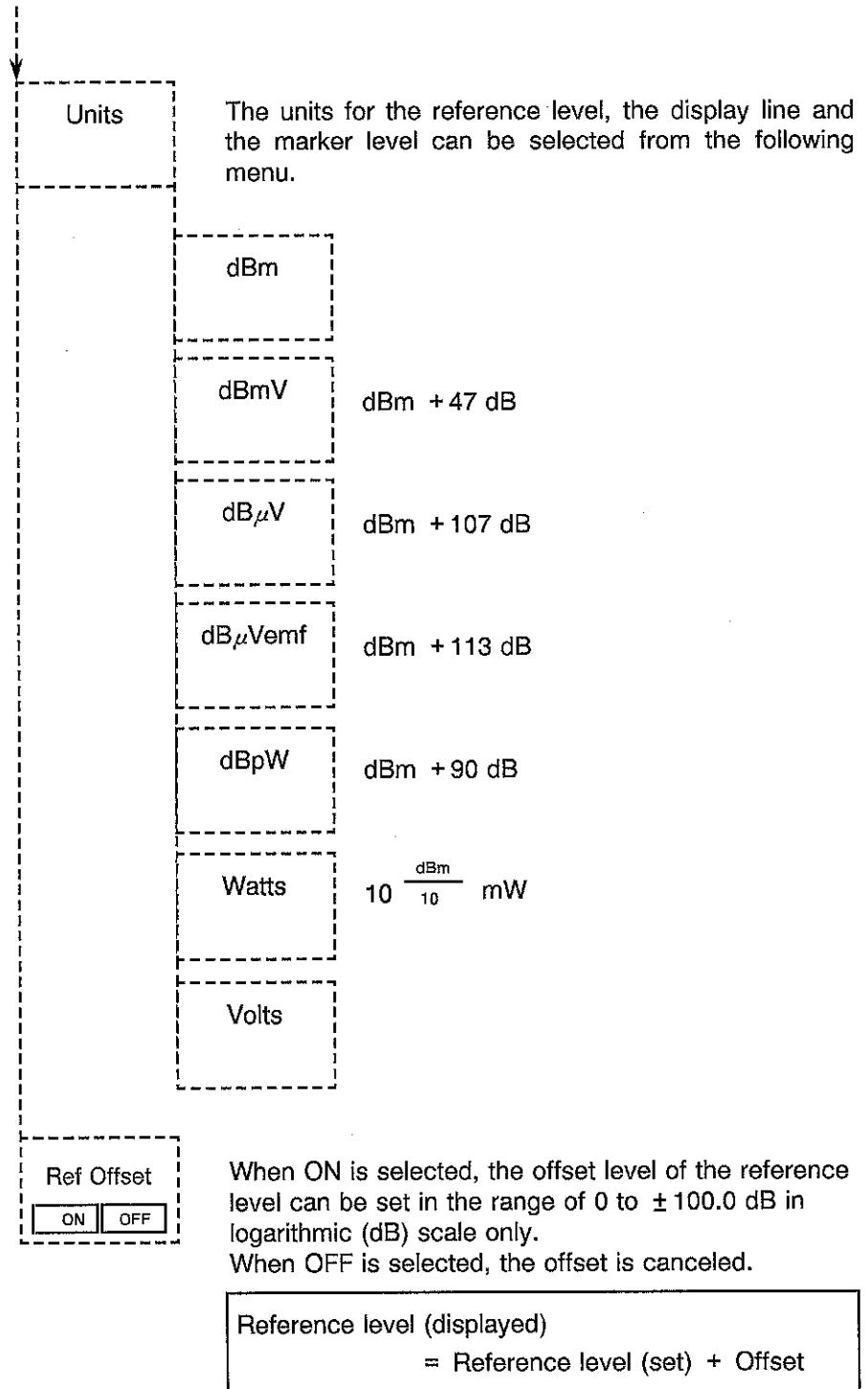

## Resolution Bandwidth (RBW)

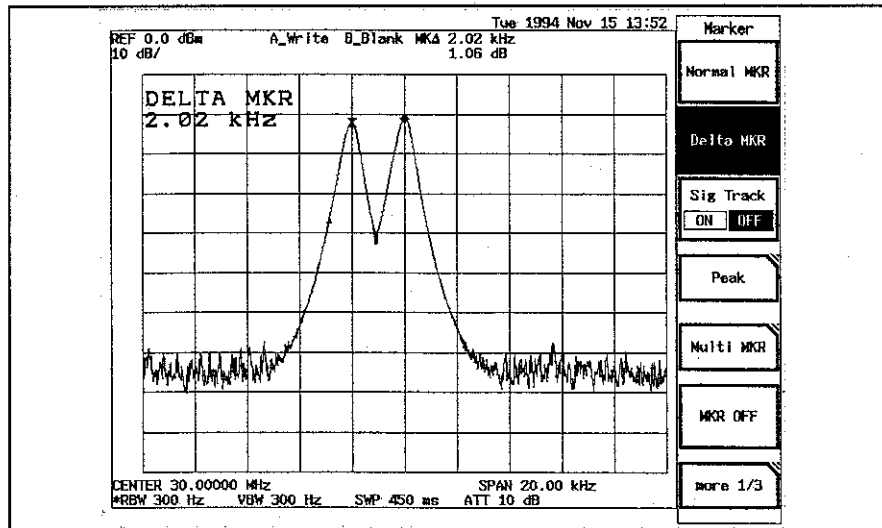
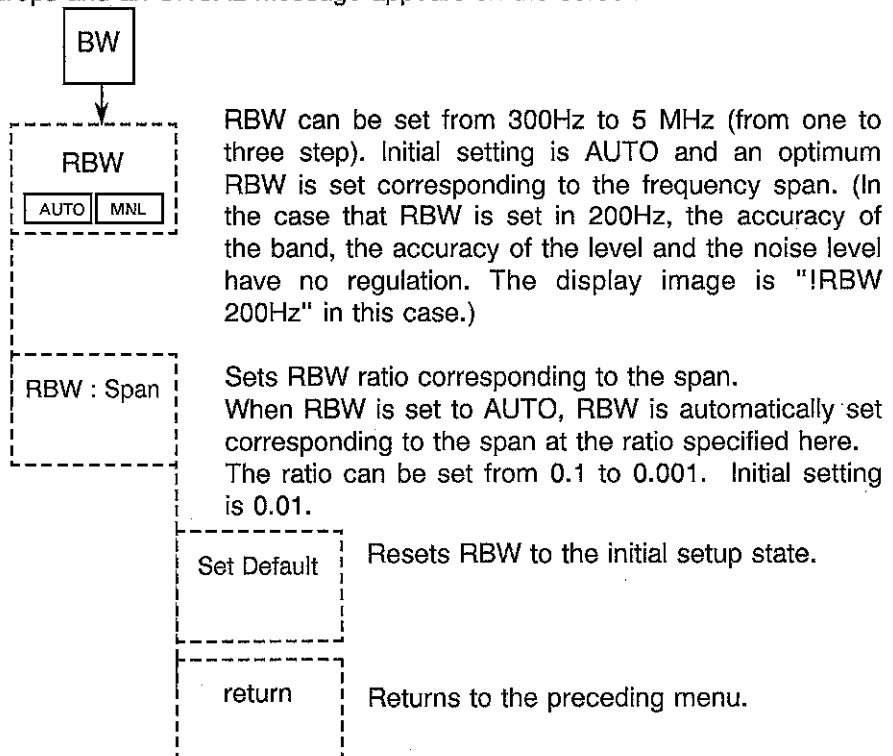

Figure 7-6 RBW : Maximum IF Bandwidth which can separate two Signals

When RBW is set very narrow, the resulting spectrum is also very fine in detail and has increased resolution of the spectral components. Thus, it is possible to separate a signal from neighboring noise, or two closely spaced spectral components. But as RBW is decreased, it takes an increasing amount of time to sweep through the same frequency range. If the sweep speed is too fast, the signal level measured at each frequency drops and an UNCAL message appears on the screen.



## ■ Video Bandwidth (VBW)

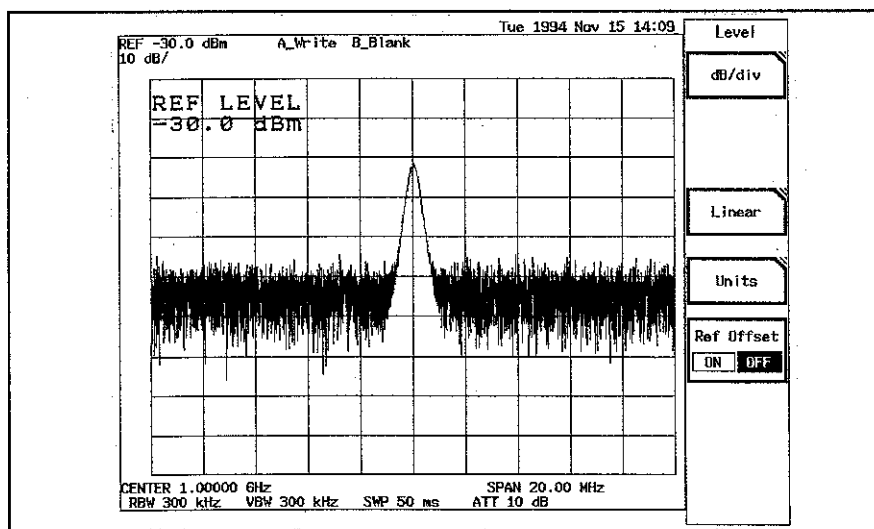

Figure 7-7 VBW = 300 kHz

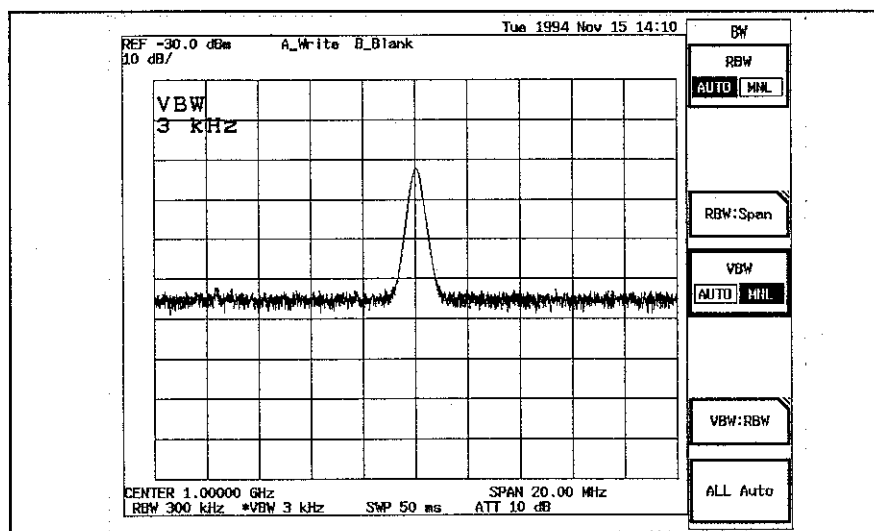

Figure 7-8 VBW = 3 kHz

VBW is used to average the input signal to reduce the noise on the signal or to reduce the noise floor. This can be useful when searching for a signal buried in noise, etc. Noise averaging is done by low pass filtering the signal. S/N ratio is improved by approximately 10 dB.

To do this noise averaging most effectively, VBW must be chosen based on the RBW setting. (Generally, a VBW of 1/10 or less of the RBW is desirable.)

If the VBW is set too narrow, the spectral levels measured will decrease from their true values because of the low pass filter time constant and UNCAL message will appear on the screen. In such a case, increase the sweep time.

1. Functions of Fundamental Keys

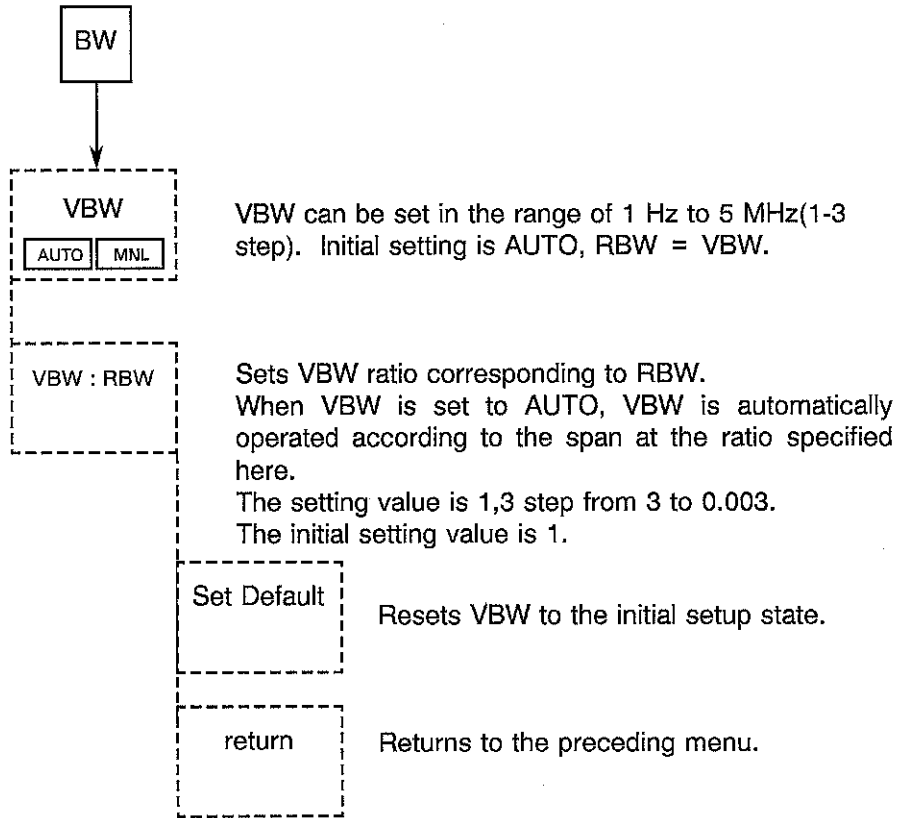

■ **Selecting AUTO of Coupled Functions**

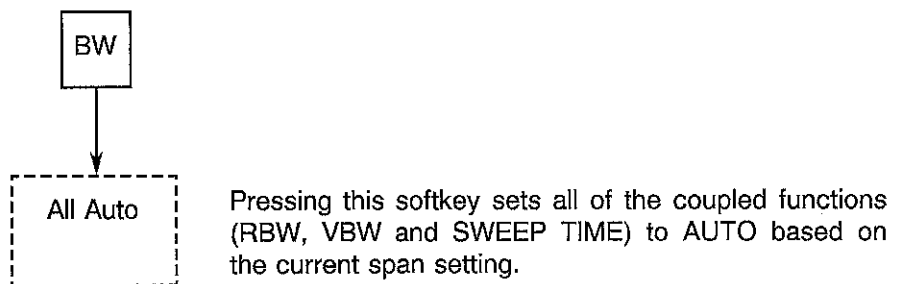

## ■ Input Attenuator (ATT)

ATT is used to protect the instrument input section from damage; to attenuate the input signal amplitude to a level where it can be measured easily; and finally to reduce undesirable distortions that could affect measurements.

ATT can be set in the range of 0 to 70dB. However, the value less than the Min ATT cannot be set.

Initial setting is Auto (10 dB). In AUTO mode, an optimum attenuation is automatically set depending on the reference level.



Minimum attenuation value is set in the Min. ATT menu for Auto and Manual range. The minimum attenuation value is limited to 10dB, so, 0dB cannot be set for Auto range.

For manual attenuation, 0dB range can be set.

When Default is selected, the minimum ATT is set to 10 dB.

This function is used to protect the input from damage and to minimize errors with level and distortion measurements.

### **Example :**

- For the level measurement, set Min ATT so that the mixer input level will be -10 dBm or less.  
 (Min ATT  $\geq$  Signal level + 10 dB)
- When distortion is measured, set [Min ATT  $\geq$  Signal level + 30 dB].  
 In case of R3465 under the frequency where the preselector operates, set [Min ATT  $\geq$  Signal level + 10 dB].

Set Default Resets Min ATT as the initial setup state.

return Returns to the preceding menu.

### ■ Input Key



Sets the offset of reference level in the range from 0 to  $\pm 100$  dB.

$$\text{Display reference level} = \text{Reference level (set value)} + \text{Offset}$$

**Example :**

This function is convenient when a fixed attenuator is connected to the input for measuring a high power signal.

For example, when +30 dBm signal is measured with a 20 dB fixed attenuator inserted, screen display becomes +10 dBm. When the offset of reference level is set to "+20 dB", +30 dBm can be read for the measured signal.

The level correction is executed for each specified frequency.

## Correction Factor Function

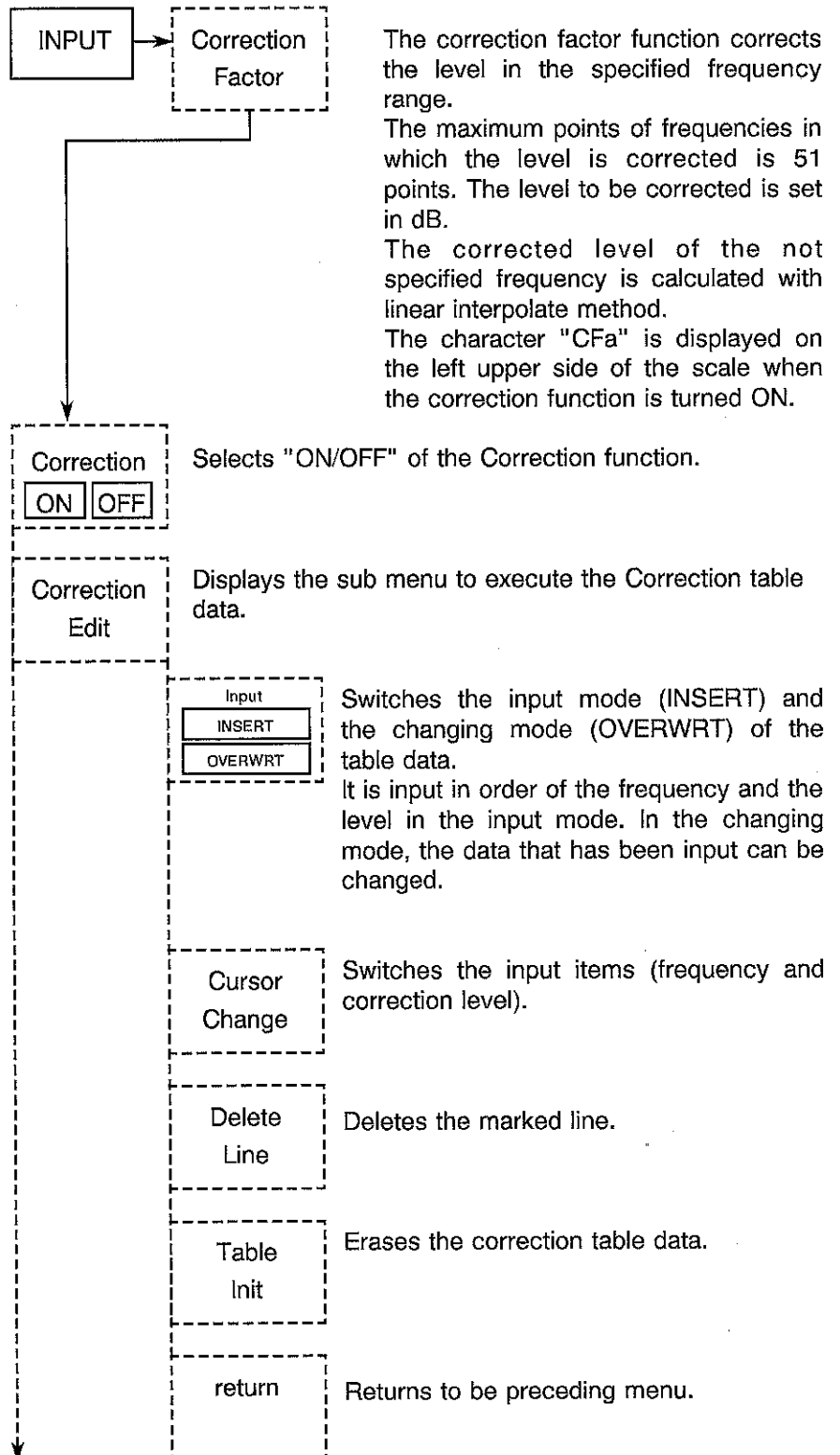

1. Functions of Fundamental Keys



<Example of the Table Data and the relationship of the level to be corrected >

- 1. 810.00MHz +0.50dB
- 2. 950.00MHz +0.30dB⇒0Hz
- 3. 1030.00MHz +0.50dB
- 4. 1700.00MHz -0.25dB

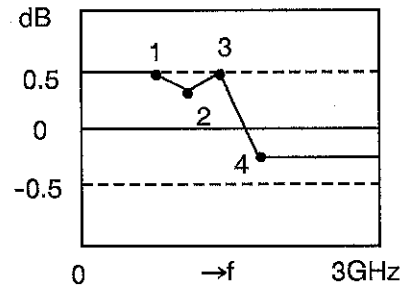

**Note**

- 1. *Input correction data is sorted in increasing order of frequency.*
- 2. *If two correction levels are set for the same frequency, a first-set correction level is effective. (In the example (1), the correction value of f2 is L1, and L1 in the example (2).) Further, if three or more correction levels are set for the same frequency, only the first and last data are effective.*

(1)

- 1. f1 L1
- 2. f2 L1
- 3. f2 L2
- 4. f3 L1

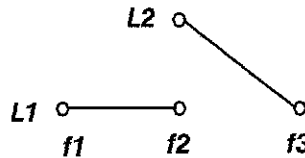

(2)

- 1. f1 L1
- 2. f2 L2
- 3. f2 L1
- 4. f3 L1

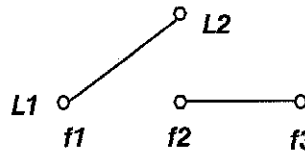



## 2. Functions of FORMAT Mode

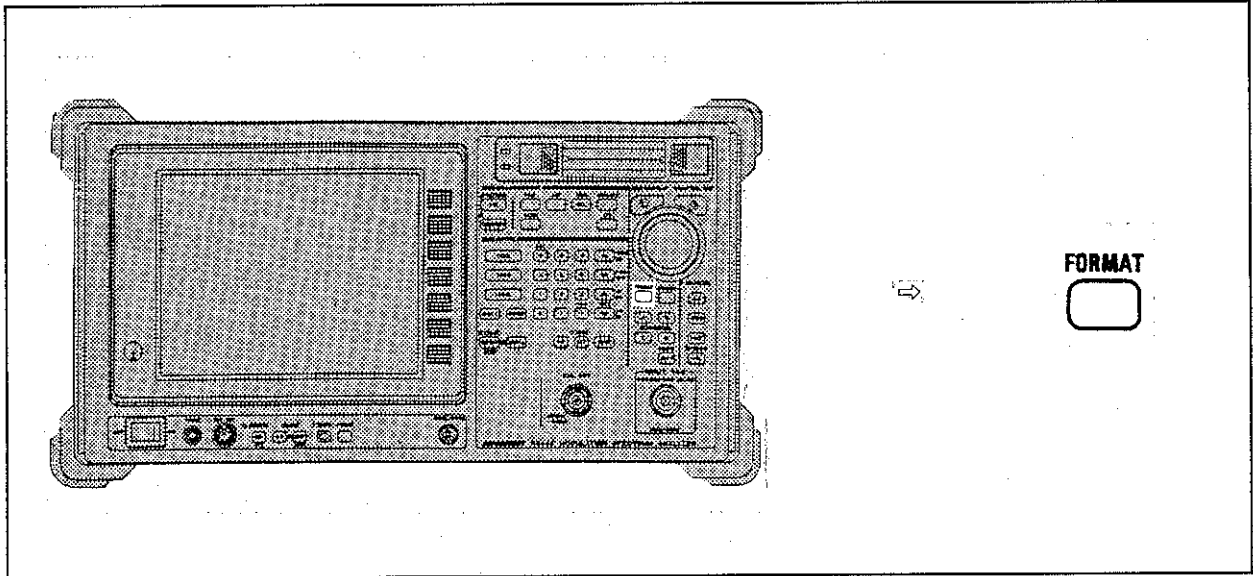
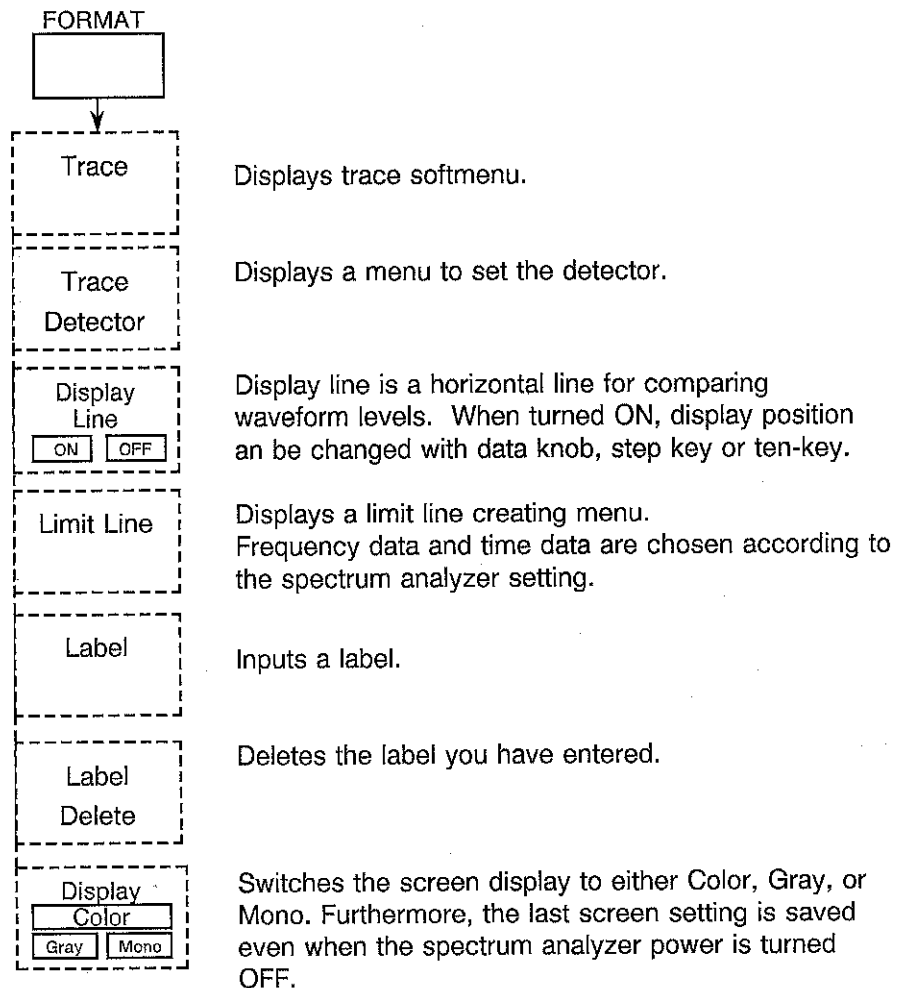

Figure 7-9 FORMAT Key on the Front Panel



## ■ Functions of TRACE mode

The instrument provides two trace memories, A and B.

The A memory has two modes. In the Write mode, the new data from each sweep writes over the data from the previous sweep. In the View mode, waveform can be stored and displayed on the screen.

The B memory has only the View mode for storing and displaying the waveform. Once a waveform has been stored in B memory, it can be manipulated with any of the many built-in waveform calculation functions, and can be used for making various waveform comparisons.

The input signal first goes through the RF/IF section. Next it is detected with a LOG/LIN amplifier, and then converted with an A/D converter. The digital data is then stored into the trace memory, where it can be controlled by the CPU, and finally displayed on the color LCD display.

### CAUTION !

*The B memory does not have a Write mode in which the new data from each sweep overwrites the previous memory data.*

*Before performing comparison of two waveforms, store the trace data into the B memory (Store B) once.*

### ● Modes of Trace A (Does not apply to the trace B)

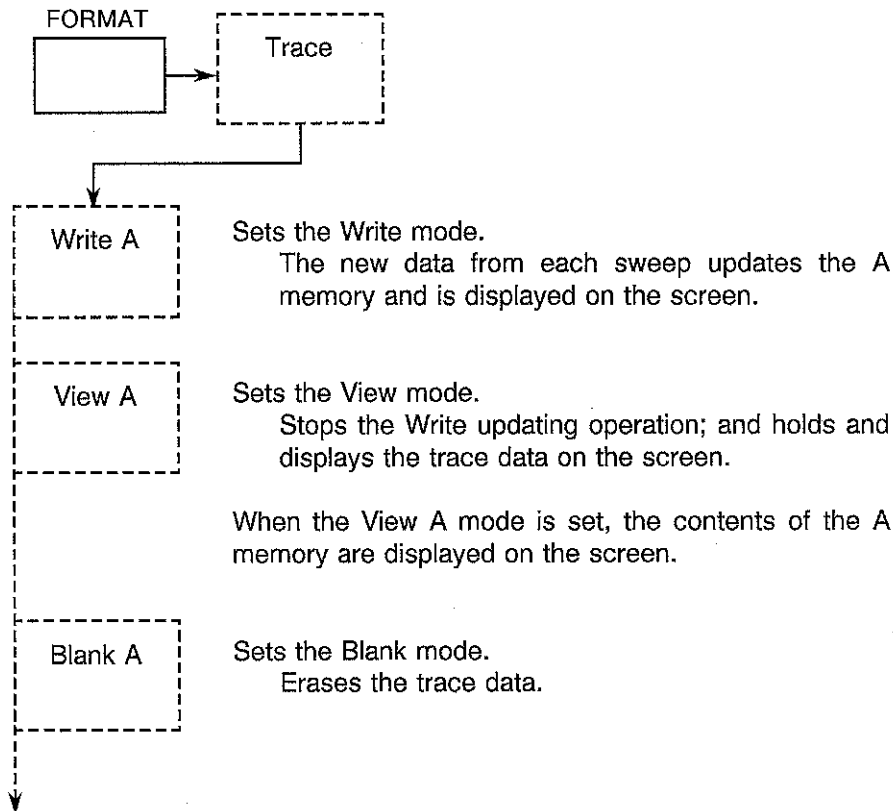

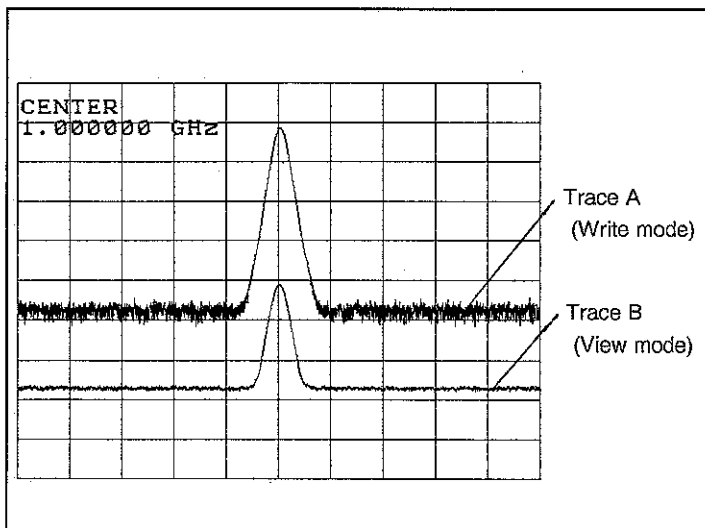

Figure 7-10 Write Mode and View Mode

Max Hold A

Max Hold A: Sets the Max Hold mode. (Not available for the Trace B)

Compares the new data for each horizontal axis point with the previous data on each sweep and displays the trace data with the larger value. Thus, the display accumulates the maximum values for each point in the horizontal axis.

Press this soft key again or Write A key to cancel Max Hold mode.

**CAUTION !**  
 Selecting this mode automatically forces the Positive detection mode.

Trace Math

● **Averaging Mode (Available only for the Trace A)**

Averaging can be used to improve S/N in a shorter time than video bandwidth filtering for noise reduction.

With averaging it is possible to recover signals buried in noise, or quantified signals with a random component.

**CAUTION !**  
 Selecting the averaging mode automatically forces the Sample detection mode.

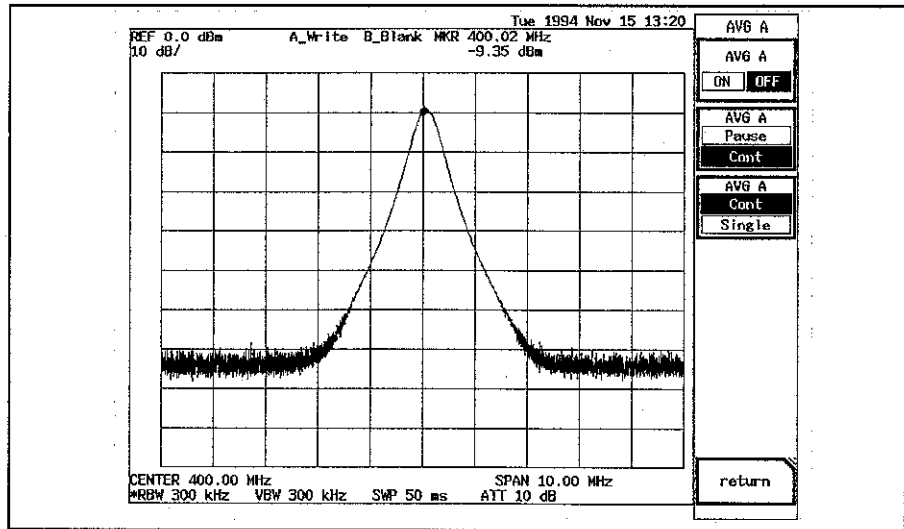

Figure 7-11 No Averaging

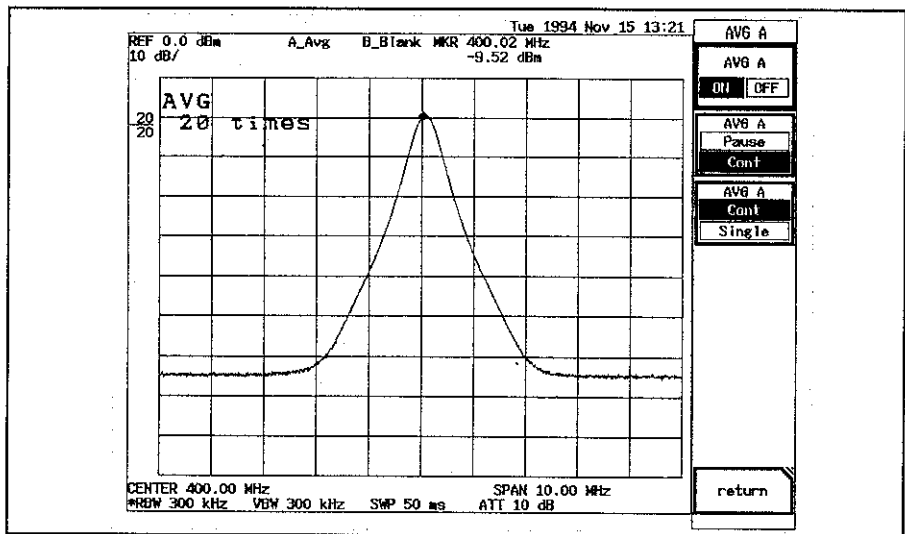
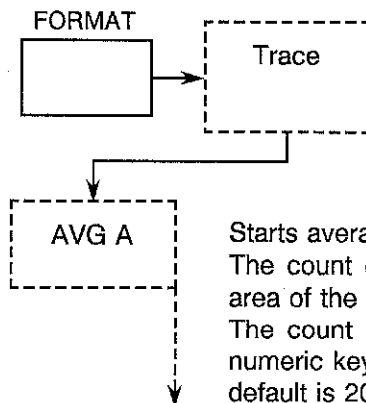

Figure 7-12 After Averaging 20 Times



Starts averaging.  
 The count of the averaging is displayed in the active area of the screen.  
 The count can be set to a value from 2 to 999 with numeric keys, step keys or the data knob. (The initial default is 20.)



Setting Pause during averaging stops averaging temporarily and displays the averaging count at this time in the active area of the screen.

Pressing this softkey again to set Cont starts the averaging from the point where it was paused.

When Cont is set, even after the desired averaging count has been reached, averaging will be repeated continuously using algorithm 2.

When Single is selected, as soon as the desired averaging count has been reached the analyzer will automatically leave the averaging and sets to the View mode.

[Averaging Algorithms]

$[N \geq n]$  : Algorithm 1

$$\bar{Y}_n = \text{Sigma}/n$$

$[N < n]$  : Algorithm 2

$$\bar{Y}_n = ((N-1) \cdot \bar{Y}_{n-1})/N + Y_n/N$$

n:	Current averaging count
N:	Averaging count specified
$Y_n$ :	Trace data for nth average
$\bar{Y}_n$ :	Averaged data for nth average
$\bar{Y}_{n-1}$ :	Averaged data for n-1th average
Sigma:	Sum of all the data up to the nth average

Returns to the preceding menu.

● Modes of Trace B

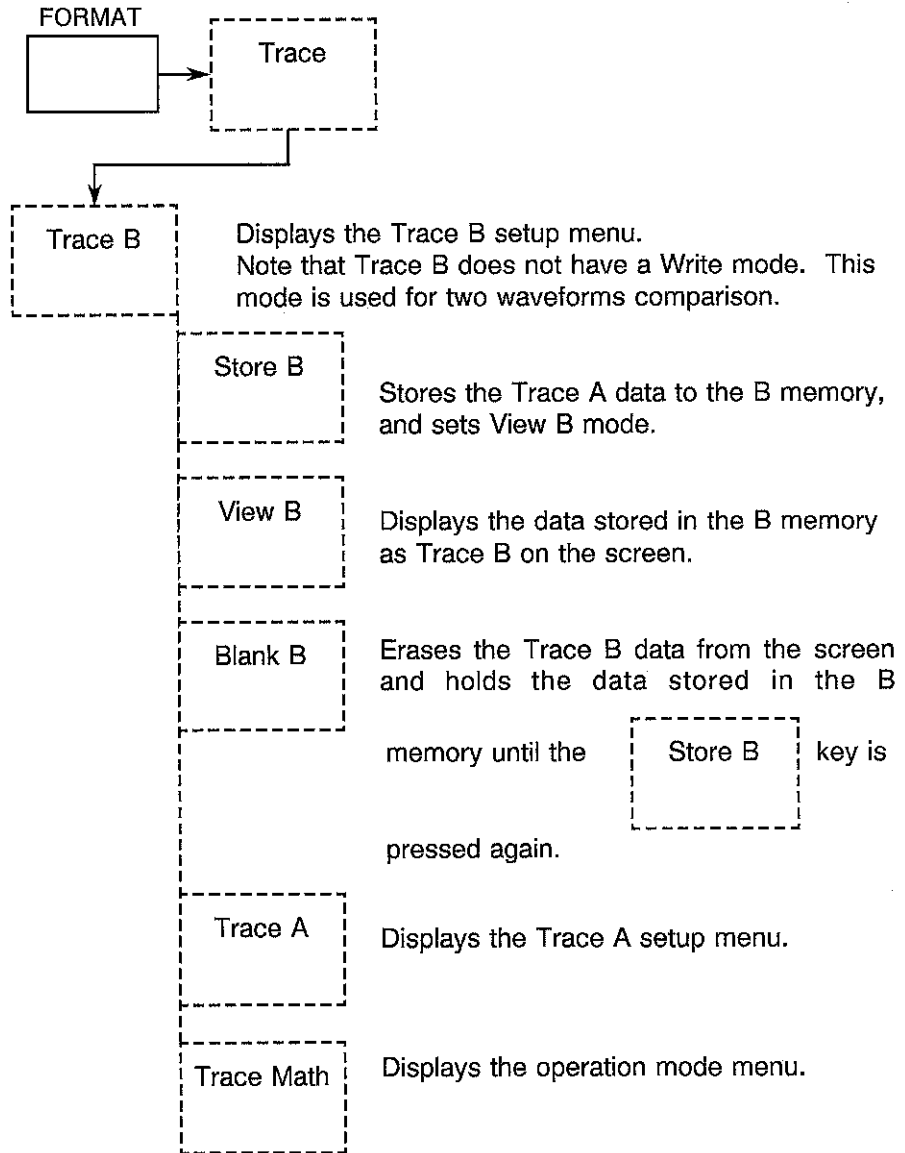

● Operation modes

Trace Math

Min Hold

A↔B

A-B→A

B-A→A

The data for each point on frequency axis are compared with new data each sweep is executed, and smaller one is stored in the memory and displayed on the screen. Therefore, the waveform becomes the time series trace of minimum values. In this mode, trace detection mode is automatically set to NEGA.

Exchanges the content of memory A with that of memory B.  
 Or exchange the content of trace A with that of trace B.

For each point, displays the result of subtracting the value of memory B from that of memory A. The content of memory B is subtracted from that of memory A or the result of sweep, and the subtraction result is stored in memory A.  
 For A VIEW or B BLANK, the content of memory B is subtracted from that of memory A, and the result is stored in memory A. When trace A is not VIEW or BLANK, the content of memory B is subtracted from the result of sweep, and the subtraction result is stored in memory A.

For each point, displays the result of subtracting the value of memory A from that of memory B. The content of memory A or the result of sweep is subtracted from the content of memory B, and the subtraction result is stored in memory A.  
 For A VIEW or A BLANK, the content of memory A is subtracted from that of memory B, and the result is stored in memory A. When trace A is not VIEW or BLANK, the content of memory B is subtracted from the result of sweep, and the subtraction result is stored in memory A.

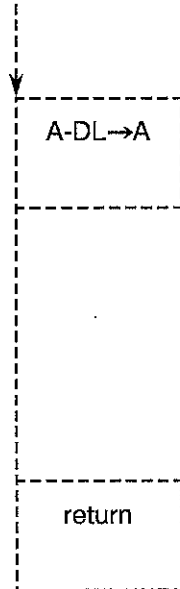

For each point, displays the result of subtracting the value of display line from that of memory A. The value of display line is subtracted from the content of memory A or the result of sweep, and the subtraction result is stored in memory A. For A VIEW or A BLANK, the value of display line is subtracted from the content of memory A, and the result is stored in memory A. When trace A is not VIEW nor BLANK, the value of display line is subtracted from the result of sweep, and the subtraction result is stored in memory A.

Returns to the preceding menu.



## ■ Explanation of Detector Mode Menu

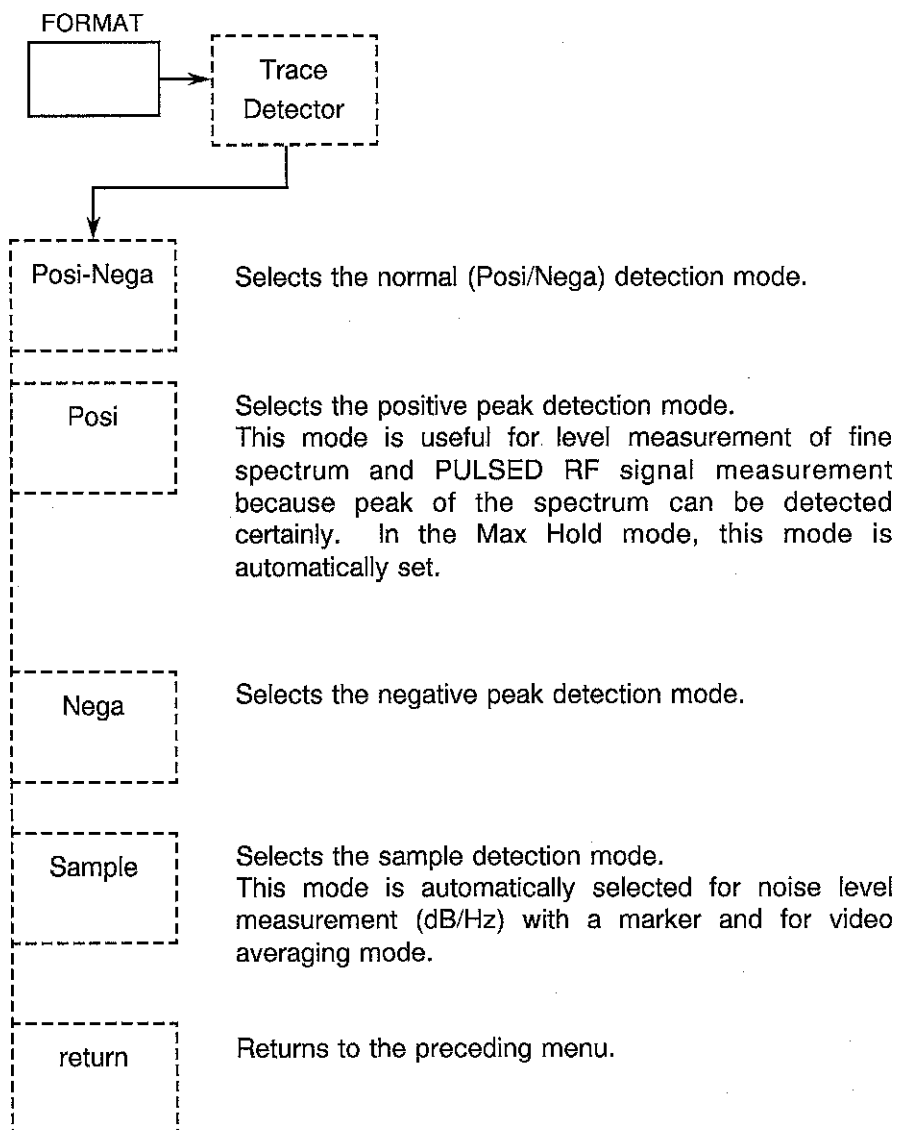

## ■ Explanation of Limit Line Menu

**Note**

*When the limit line is displayed in the CW mode, the judgment of Pass or Fail is carried out every measurement sample.*

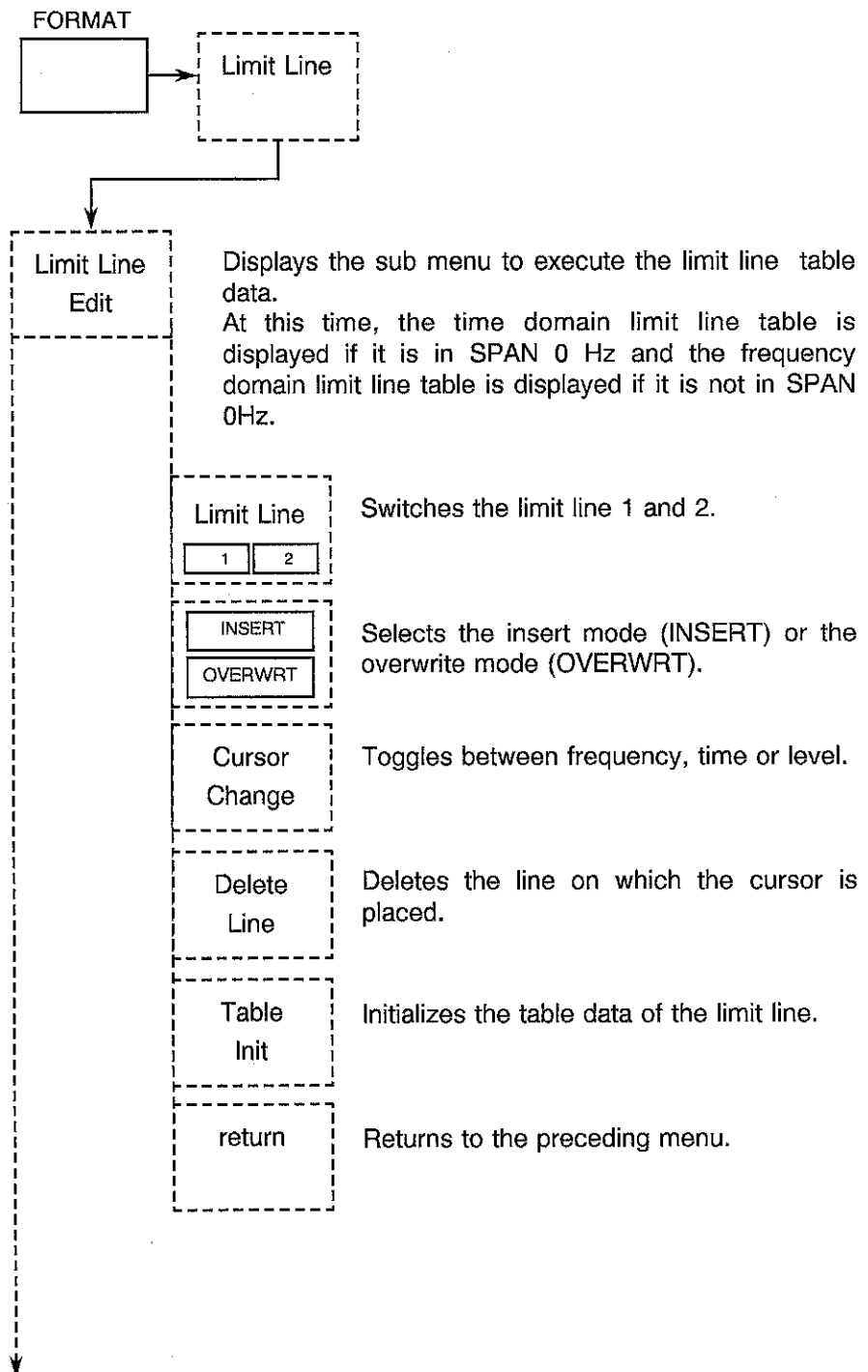

X <input type="checkbox"/> ABS <input type="checkbox"/> REL	Switches absolute data display and relative data display of the frequency data if it is not in SPAN 0Hz. Switches absolute data display and relative data display of the time data if it is in SPAN 0 Hz. The relative data display is based on DELAY TIME when DELAY SWEEP is turned ON.
Y <input type="checkbox"/> ABS <input type="checkbox"/> REL	Switches absolute data display and relative data display for the level data. The display line is a basis for marker relative data display.
Shift <input type="checkbox"/> X <input type="checkbox"/> Y	Shifts the entered frequency (or time) data or level data.
Limit Line 1 <input type="checkbox"/> ON <input type="checkbox"/> OFF	Switches ON and OFF the limit line 1.
Limit Line 2 <input type="checkbox"/> ON <input type="checkbox"/> OFF	Switches ON and OFF the limit line 2.
Copy Table	Copies a data table of the limit line.
Copy Table 1 to 2	Copies a data table of the limit line from 1 to 2.
Copy Table 2 to 1	Copies a data table of the limit line from 2 to 1.
return	Returns to the preceding menu.

## Label Function

Label input is performed for the waveform display. The documentation text can be used for a plotter output and a memory card function.

### Labeling Procedure

- 1 Press the **FORMAT** key and the **Label** key in the order.

The label input screen (Figure 7-13) is displayed and a label can be entered.

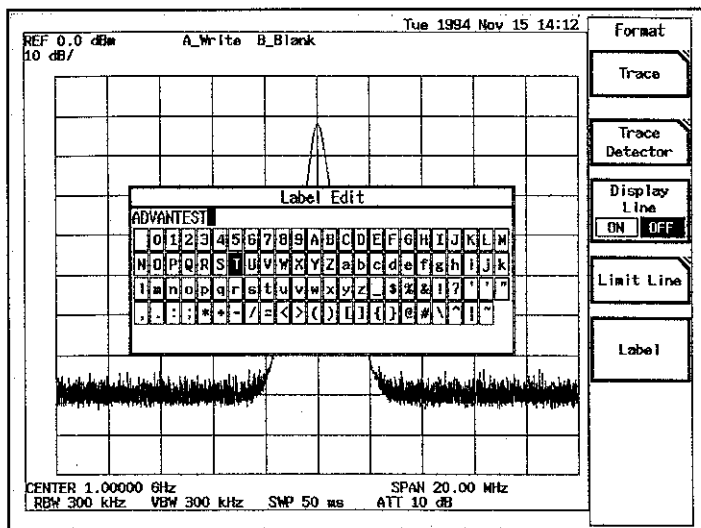

Figure 7-13 Label Input Screen

- 2 With step key and data knob, set characters.

Pressing the step key moves the cursor vertically. Turning the data knob moves the cursor horizontally. Pressing the data knob defines the input characters.

### CAUTION !

Press **B-S** key to correct or delete the input characters.

- 3 Press **ENTER** key to input characters.

### 3. Functions of MARKER Section

Normal marker and  $\Delta$  marker can be placed on the frequency being displayed, and the frequency and the level data at that point are displayed.

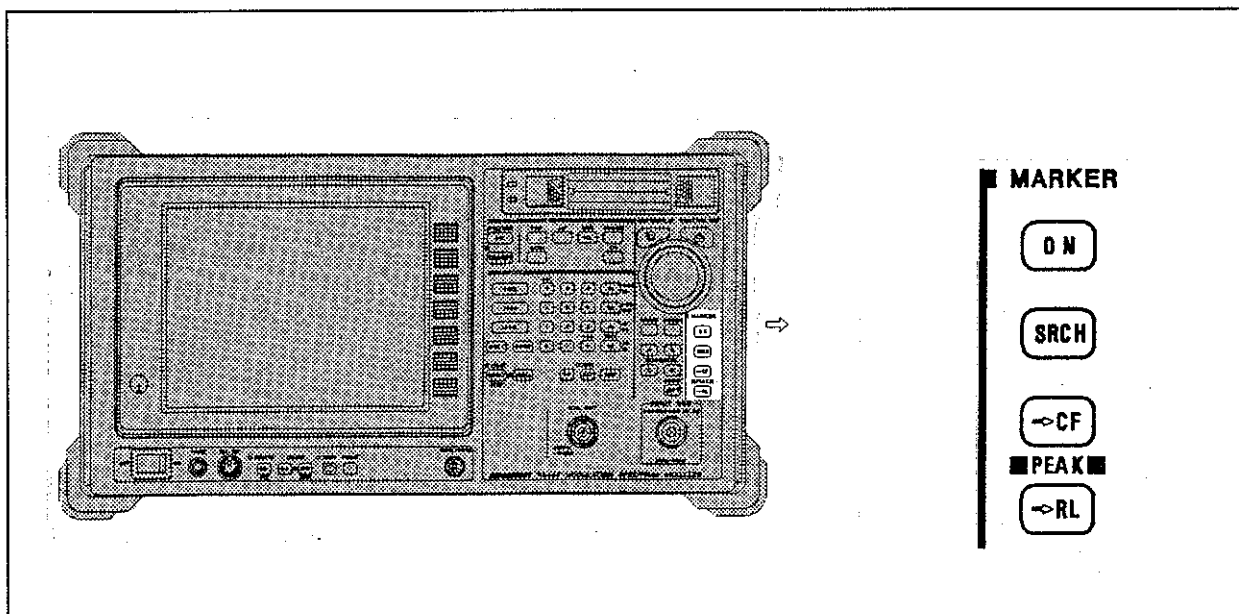
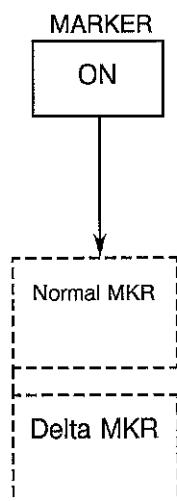

Figure 7-14 MARKER Section Key on the Front Panel

#### ■ Marker ON

##### ● Normal Marker and $\Delta$ Marker



Pressing the "ON" key turns the marker ON: the marker ( $\blacklozenge$ ) is shown on the waveform, and the frequency and level parameters at the marker position are displayed on the screen.

The marker can be moved with the numeric keys and units keys, the step keys and the data knob.

Displays the normal marker ( $\blacklozenge$ ).

Displays the  $\Delta$  marker ( $\blacktriangle$ ) at the same place as the normal marker. The relative differences between  $\Delta$  marker and normal marker in frequency and level are displayed in the marker area.

Data input for the frequency difference between the two markers can be made with the numeric keys and units keys, step keys and the data knob.

Doing so, the normal marker moves with  $\Delta$  marker fixed.

### ■ Signal Track Mode

In this mode, the peak level of the signal on which a marker is displayed is detected on each sweep, and then the center frequency is moved to that frequency. This is useful to track and analyze the signals with drifting frequency. The condition for detecting a signal is dependent on the "PEAK  $\Delta$  Y div" setting.

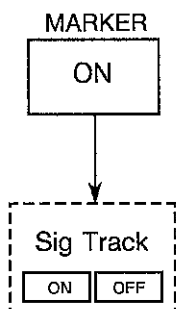

When ON is selected, the signal track mode is set. If the span is set to narrow in the signal track execution, span can be changed in steps by the AUTO ZOOM function. However, AUTO ZOOM functions only when span is changed with numeric keys and units keys.

When OFF is selected, the signal track mode is canceled.

### ■ Peak Search

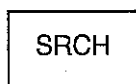

Finds the highest level of the waveform being displayed, and moves the marker there. Displays that frequency and level.

If a measurement window is ON, then the peak search is performed inside the window.

#### ● Explanation of Next Peak Search Menu

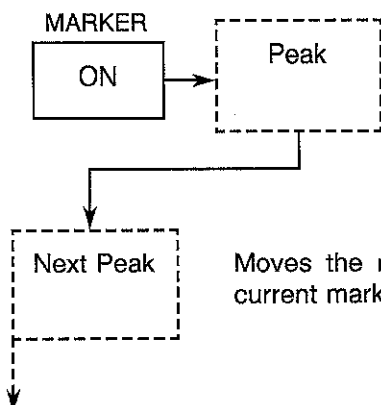

Moves the marker to the next higher peak from the current marker position.

Next Peak Left	Moves the marker to the peak with the next lower frequency than the current marker point.
Next Peak Right	Moves the marker to the peak with the next higher frequency than the current marker point.
Min Peak	Moves the marker to the lowest level of the waveform being displayed.
Next Min	Moves the marker to the next lowest level than the current marker point in increasing level order.
Cont Peak <input type="checkbox"/> ON <input type="checkbox"/> OFF	Enables continuous peak searching. When ON is selected, a peak search is done after every sweep, and the frequency and the level are displayed. When OFF is selected, the continuous peak search is canceled.
more 1/2	Displays menu on the following page.
Peak Delta Y	Sets the amplitude condition for next peak search. For further details, refer to Page 7-32.
Search <input type="checkbox"/> ALL <input type="checkbox"/> Up <input type="checkbox"/> Low	Changes the peak search level. For further details, refer to Page 7-33.
return	Returns to the preceding menu.
more 2/2	Returns to the menu on the previous page.

● Amplitude Condition for Next Peak Search

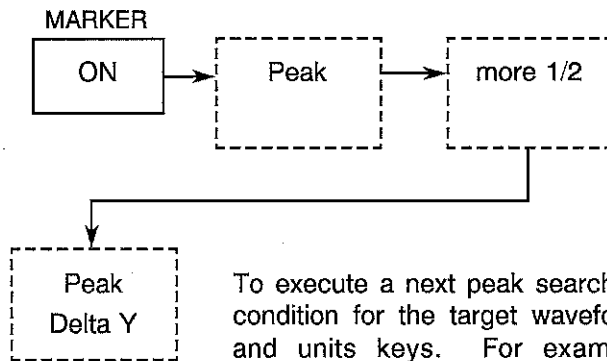

To execute a next peak search, set up the amplitude condition for the target waveform with numeric keys and units keys. For example, entering "1div" corresponds to 1 division on the horizontal axis. In case of the signal shown in Figure 7-15, it is necessary to treat each signal as a single amplitude (target for the next peak search) so that the next peak search can be executed to find the entire waveform amplitude data.

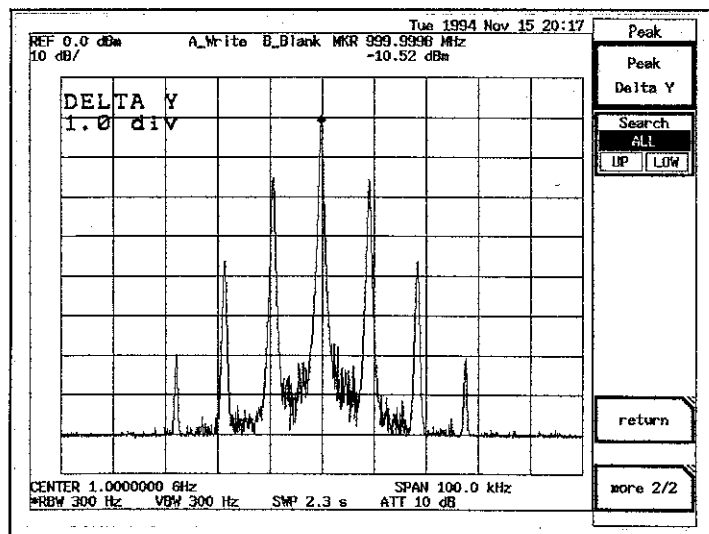

Figure 7-15 Next Peak Search Execution

Thus the target waveform for the next peak search as a  $\Delta Y$  can be set by using the amplitude value (div).



●  $\Delta Y$  Setting

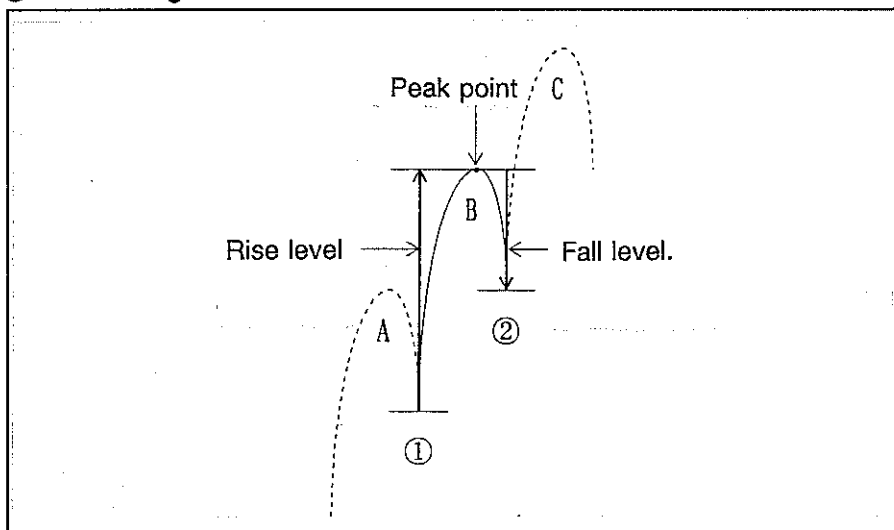

Figure 7-16  $\Delta Y$  Setting

The waveform B rises from the point ① and falls from the highest point (peak) to the point ②.

If the value for  $\Delta Y$  is set even much lower than the rise/fall levels, the waveform B will be an object for the next peak search.

If the waveform amplitude data to be measured is much higher than the level of  $\Delta Y$  which has been set, the waveform data is always an object for peak search.

● Peak Search Level Changing

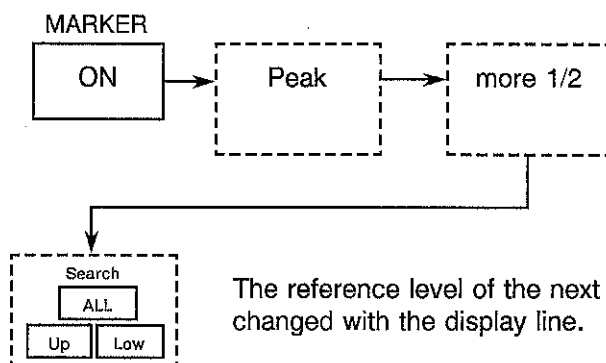

The reference level of the next peak search can be changed with the display line.

ALL : Executes a next peak search for the complete display. (Initial state)

Up : Executes a next peak search for levels above the display line. (See Figure 7-17.)

Low : Executes a next peak search for levels below the display line. (See Figure 7-18.)

To select Up or Low, adjust the level when the display line is ON.

< Display Line Setting >

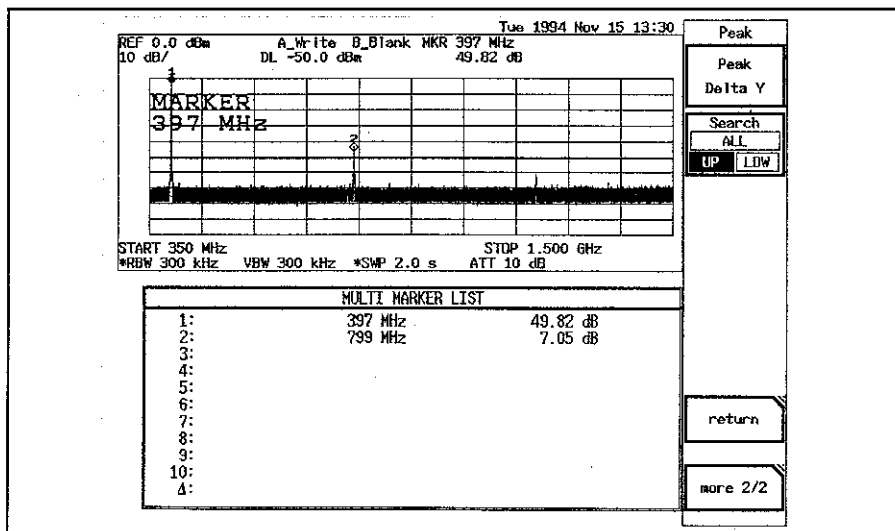
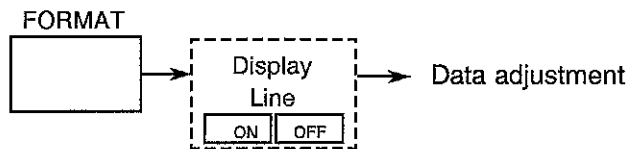

Figure 7-17 In the Case of Up Setting

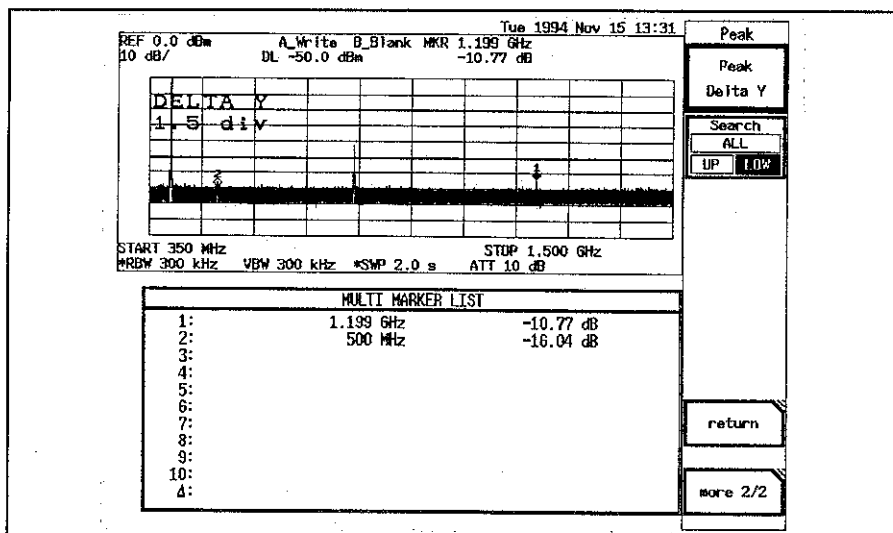
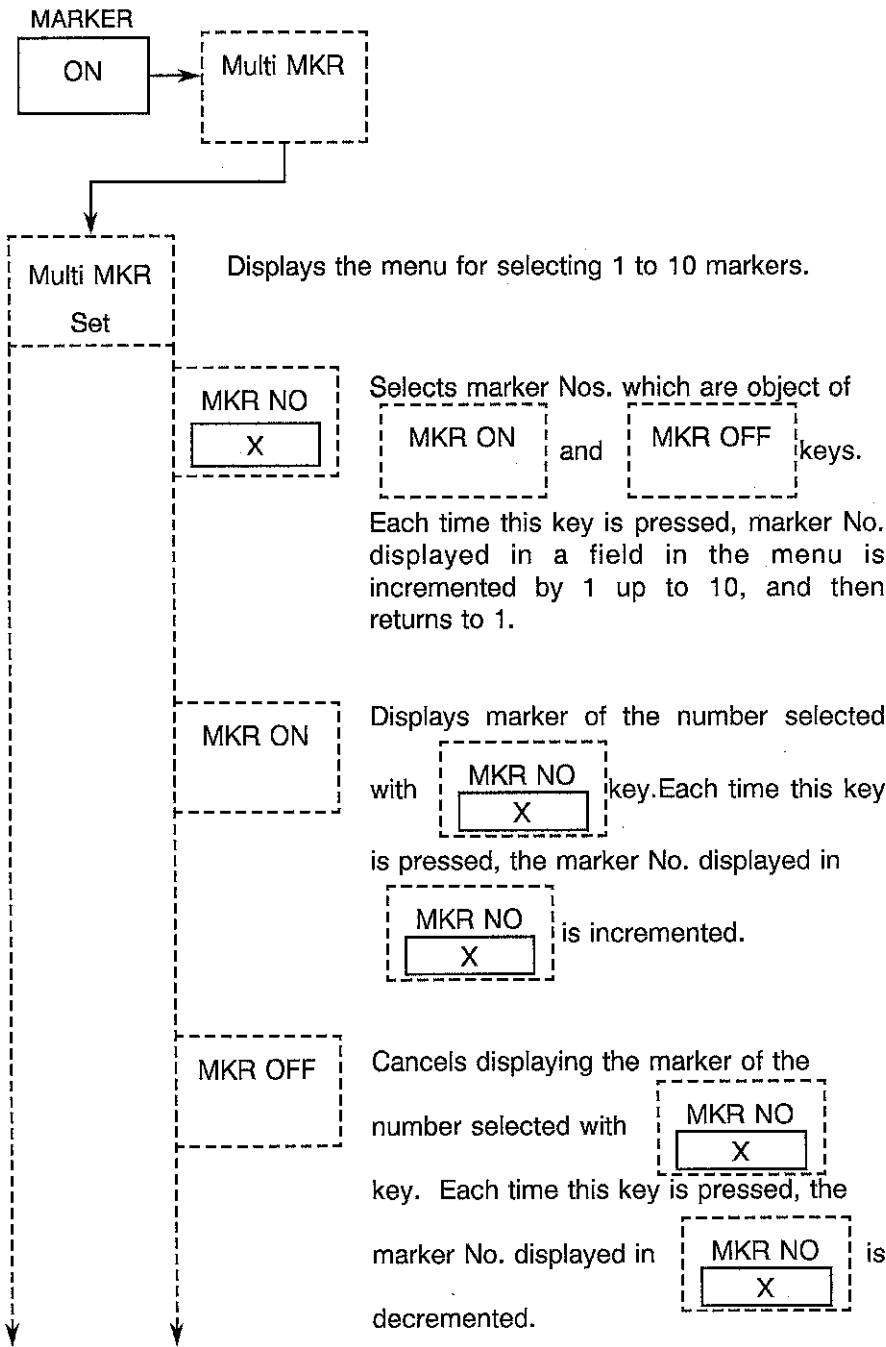

Figure 7-18 In the Case of Low Setting

■ Multi-marker mode

With multi-marker function, maximum 10 markers can be displayed. Thus, frequency and level values at multiple points can be measured at the same time.

One of the maximum 10 markers becomes active marker, which can be moved with ten-key, step key or data knob.



3. Functions of MARKER Section

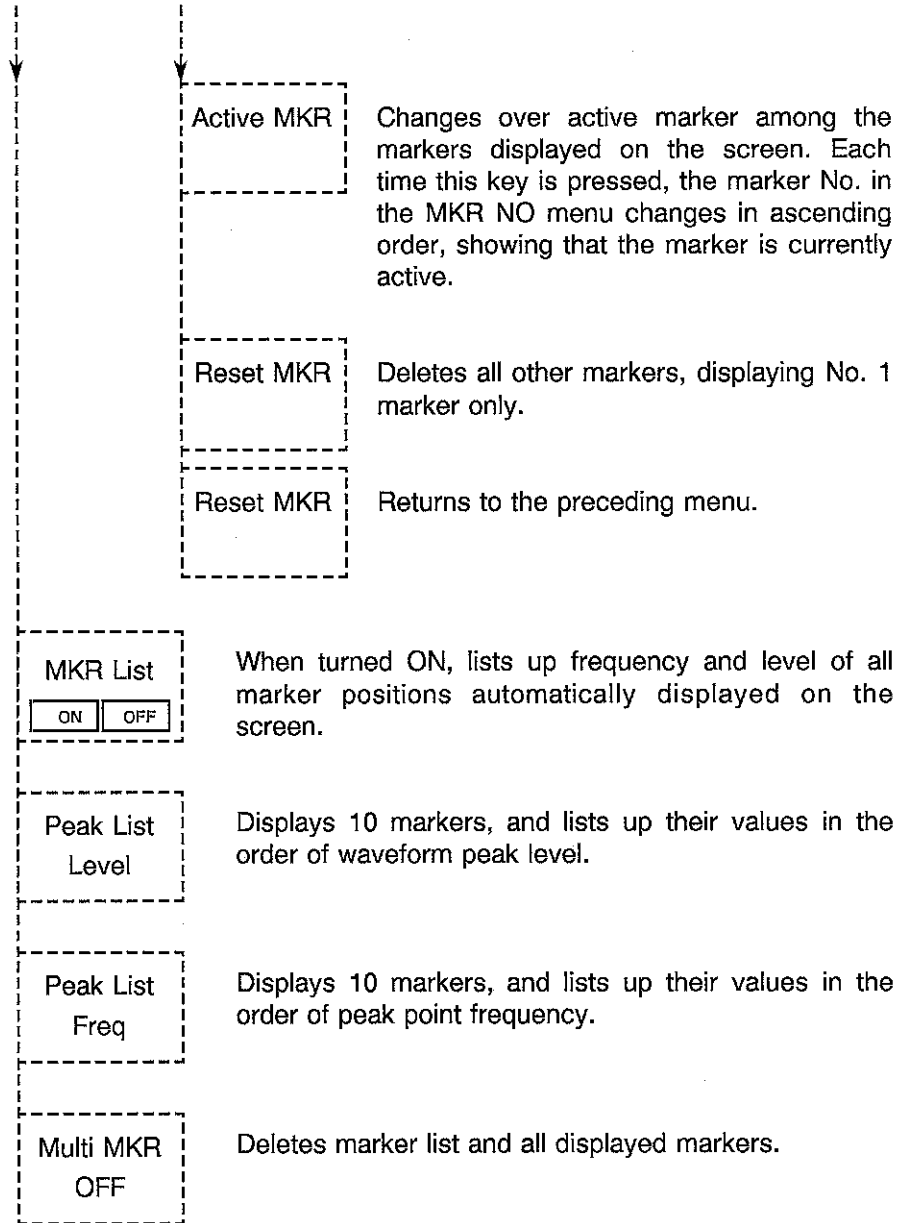

■ Marker → (Marker to)

Sets the current marker data (frequency, level, Δ, etc.) as the data for some other function.

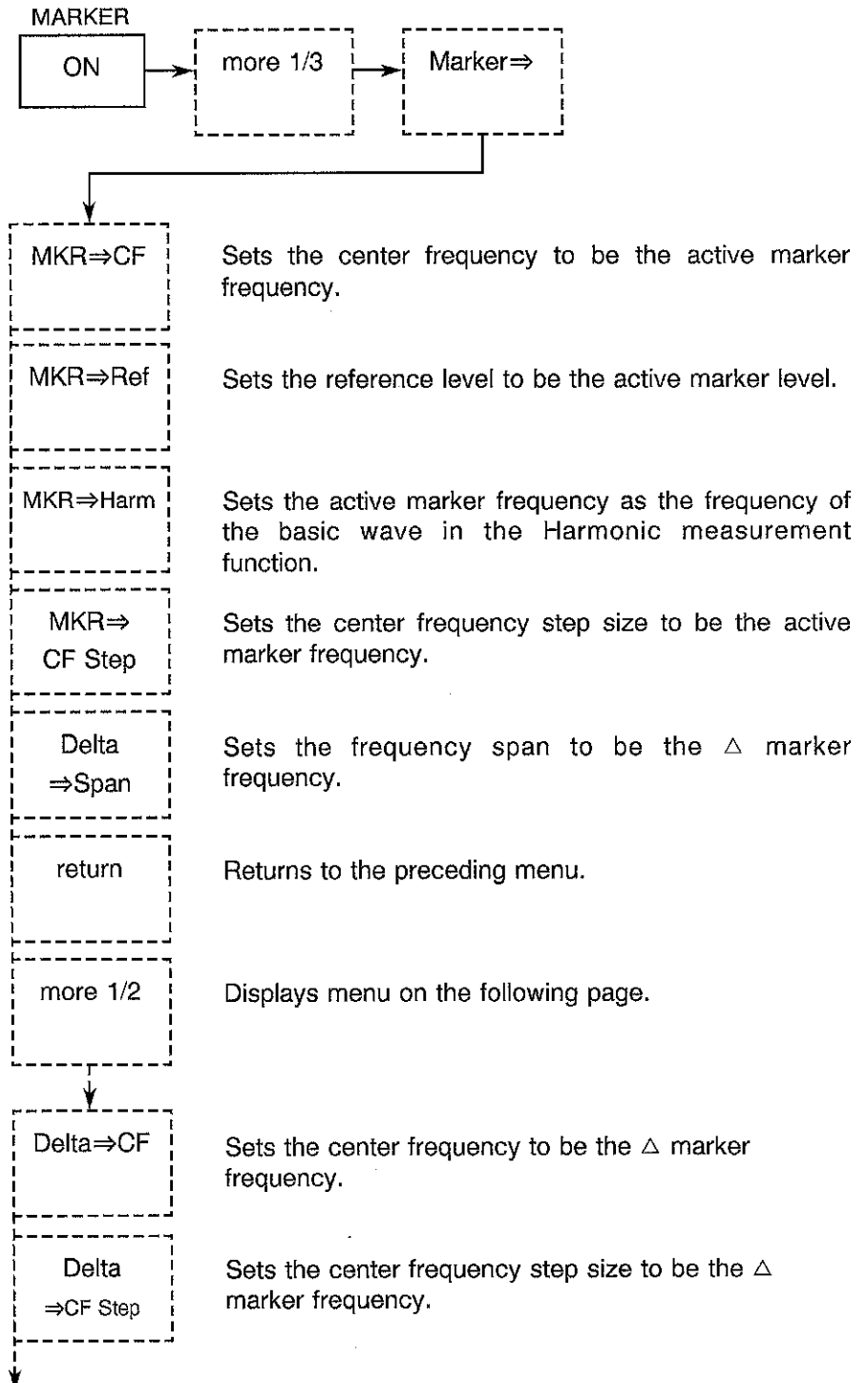

↓ MKR⇒ MKR Step	Sets the marker step size to be the active marker frequency.
Delta⇒ MKR Step	Sets the marker step size to be the $\Delta$ marker frequency.
return	Returns to the preceding menu.
more 2/2	Returns to the menu on the previous page.

● MKR⇒CF, MKR⇒REF Function

⇒CF	Moves the marker to the maximum level of the waveform being displayed, and sets the center frequency to the frequency of the marker point.
⇒RL	Moves the marker to the maximum level of the waveform being displayed, and sets the reference level to the level of the marker point.

## Other marker functions

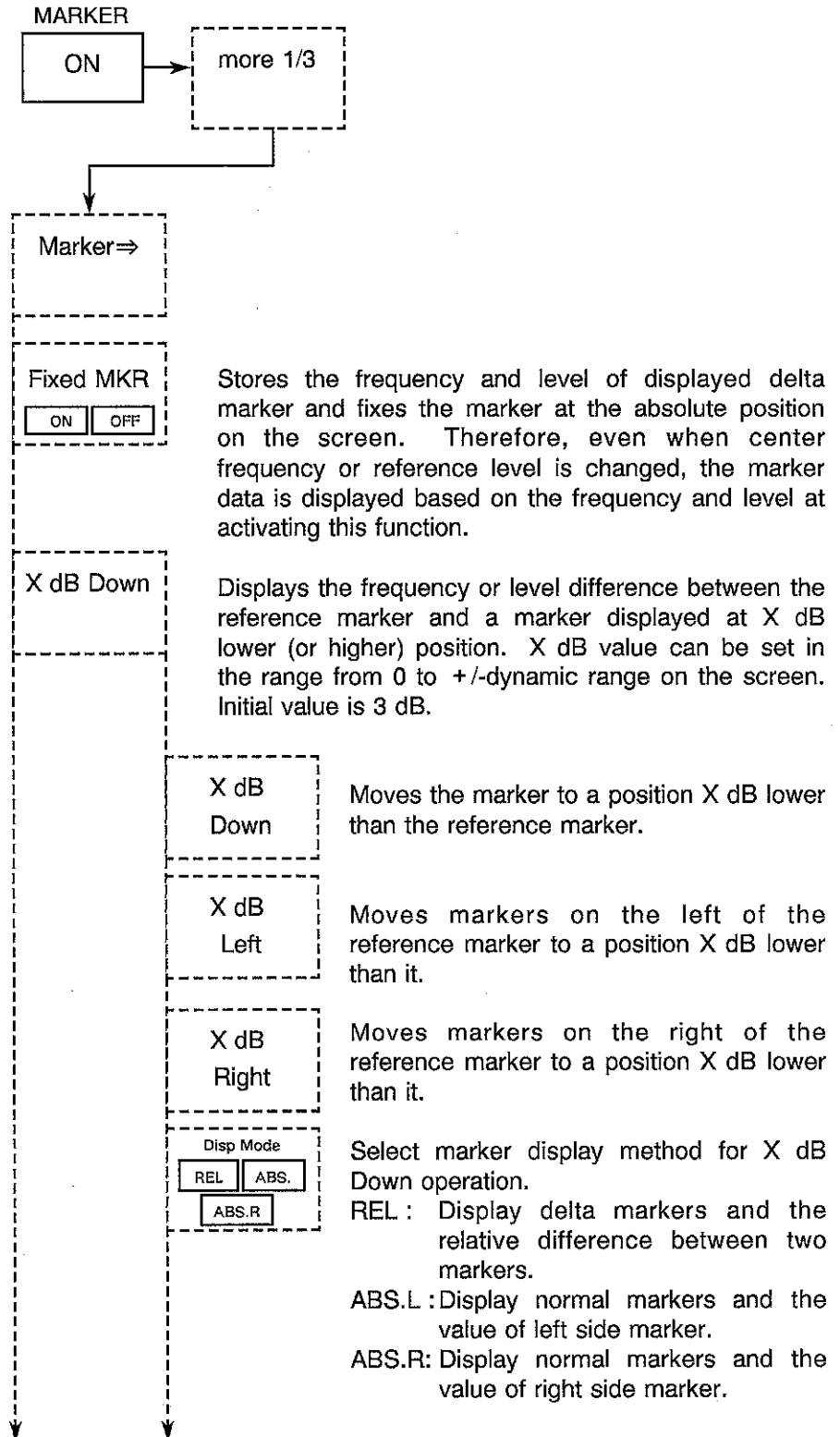

3. Functions of MARKER Section

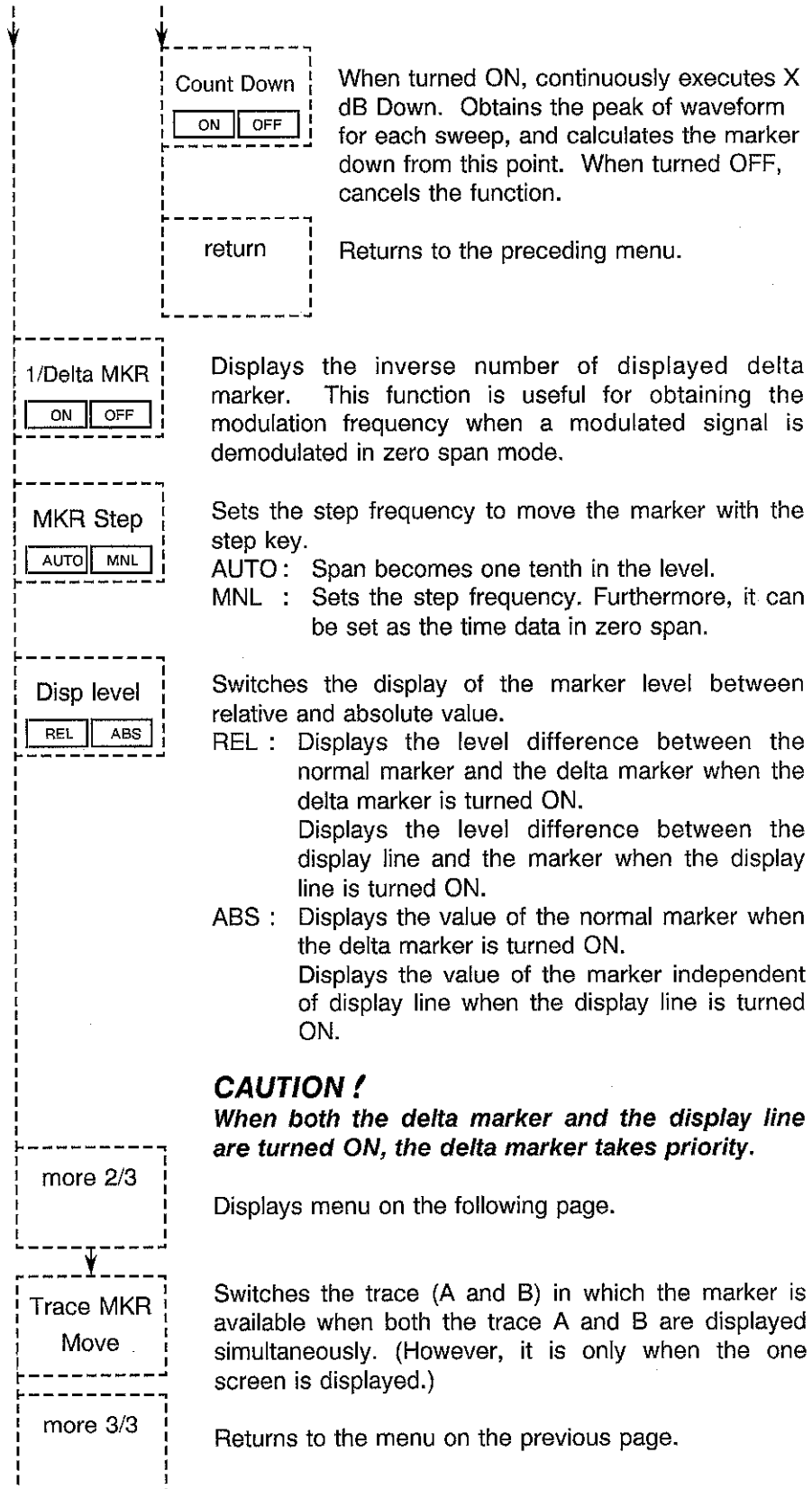

**CAUTION !**  
 When both the delta marker and the display line are turned ON, the delta marker takes priority.



## ■ Marker OFF

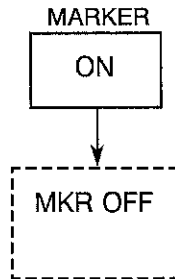

Erases all markers from the display. If there are any marker related functions active, set them OFF.

Functions which will be turned off are:

- Counter
- Sound
- Signal track
- Power Meas
- Noise/Hz
- Delta marker
- Continuous peak search
- Continuous dB down
- Multi marker list

## 4. Functions of SWEEP Mode

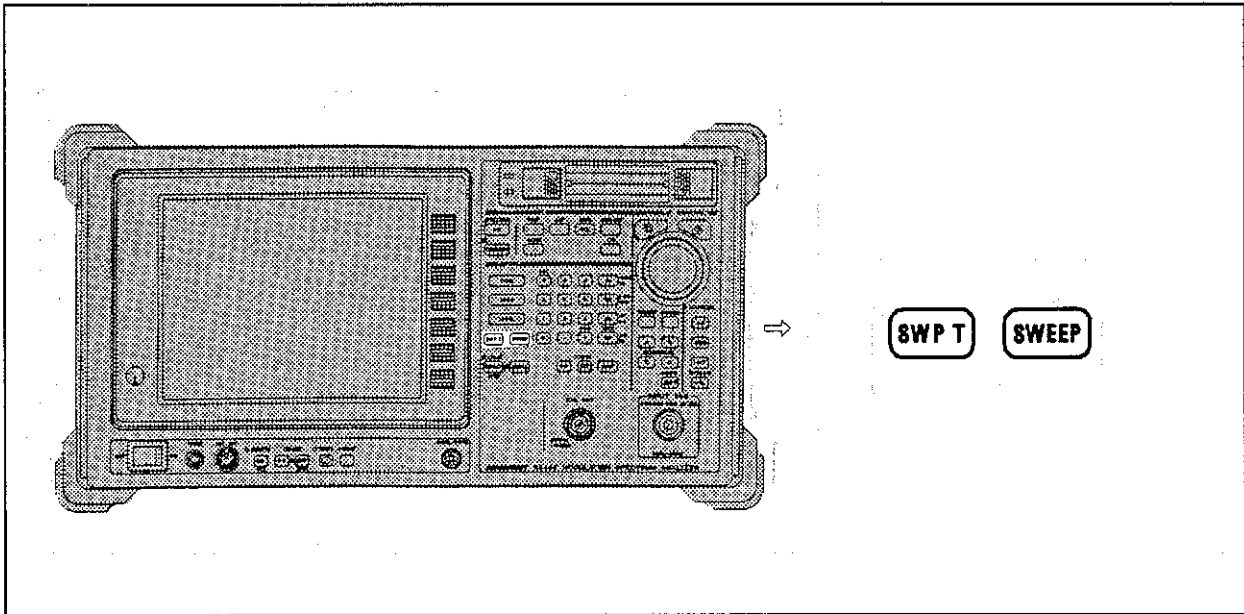
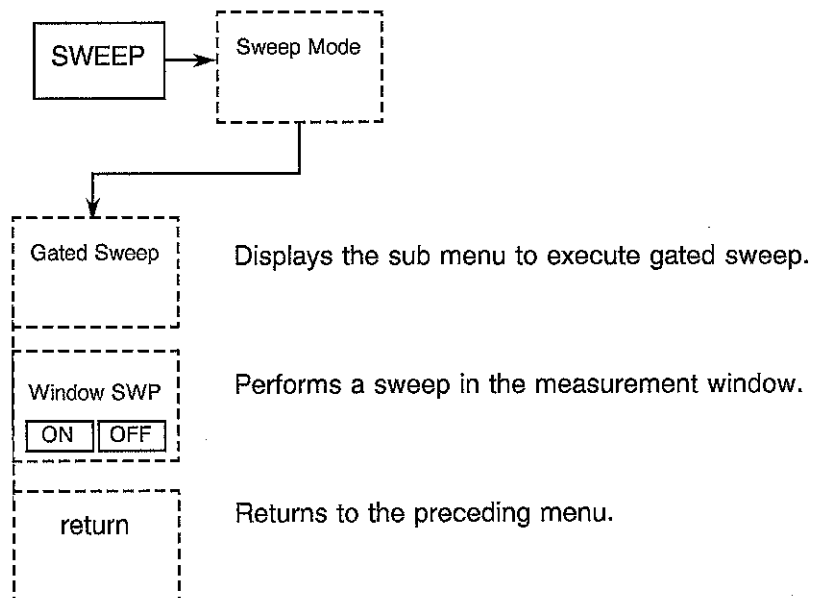

Figure 7-19 MARKER Section Key on the Front Panel

### ■ Sweep Key

#### ● Explanation of Sweep Mode Menu



## ■ Explanation of Gated Sweep Function

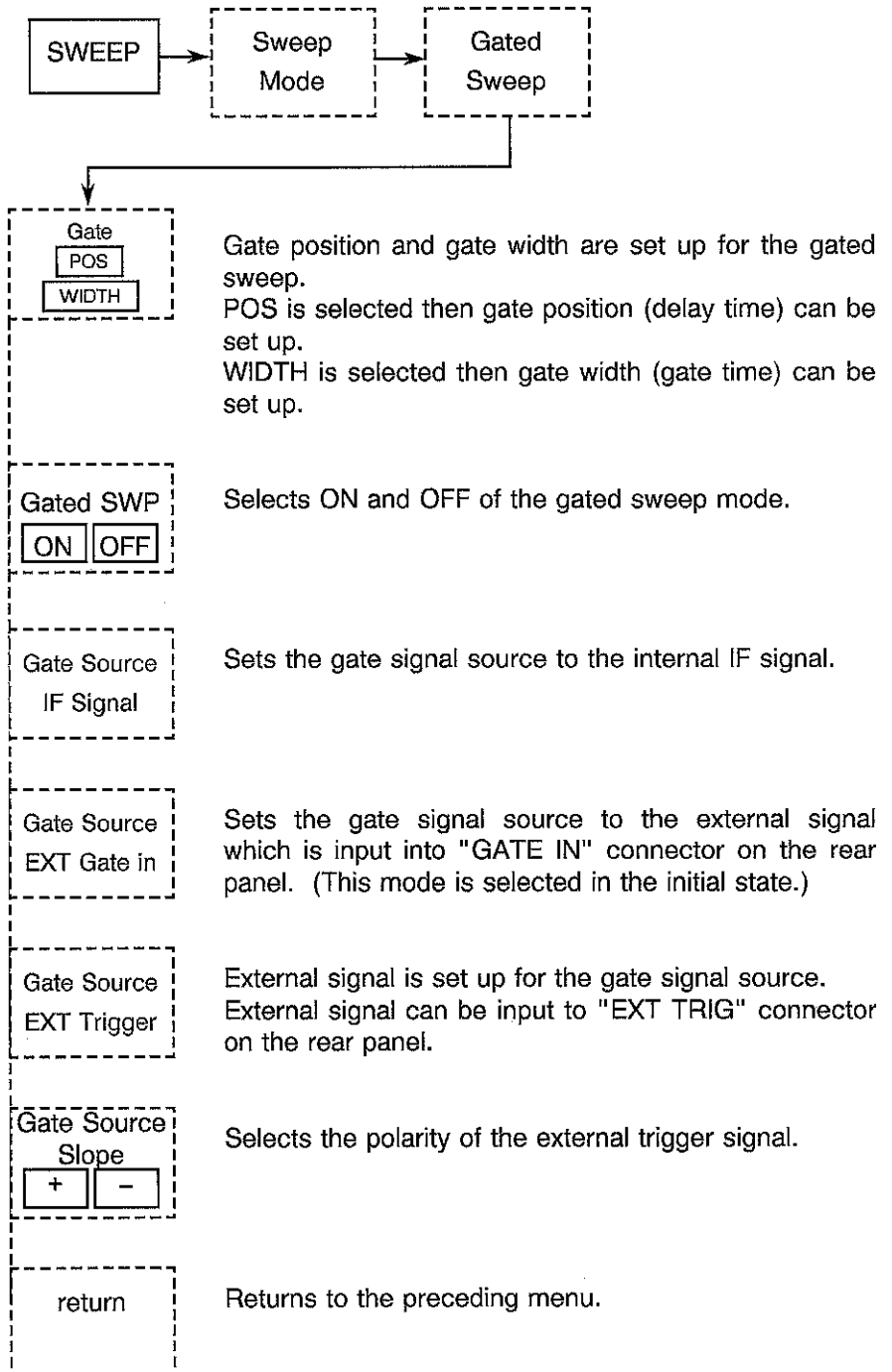

● Explanation of Trigger Menu

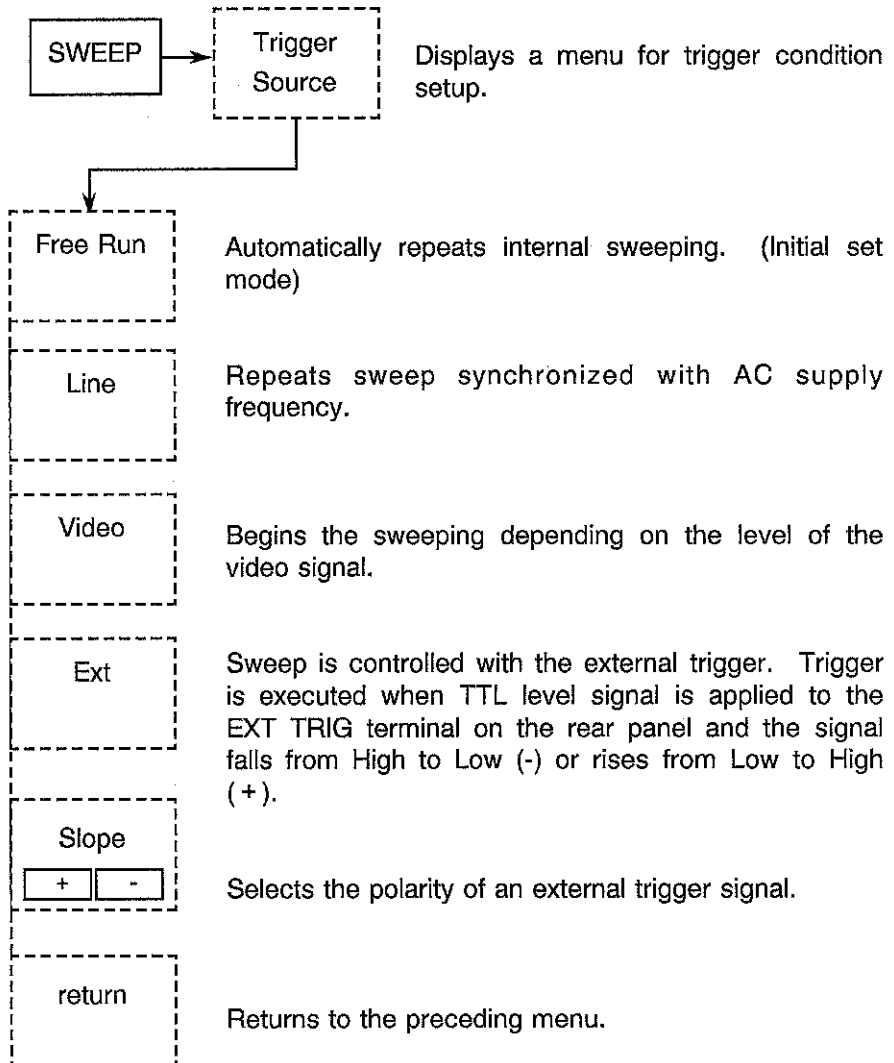

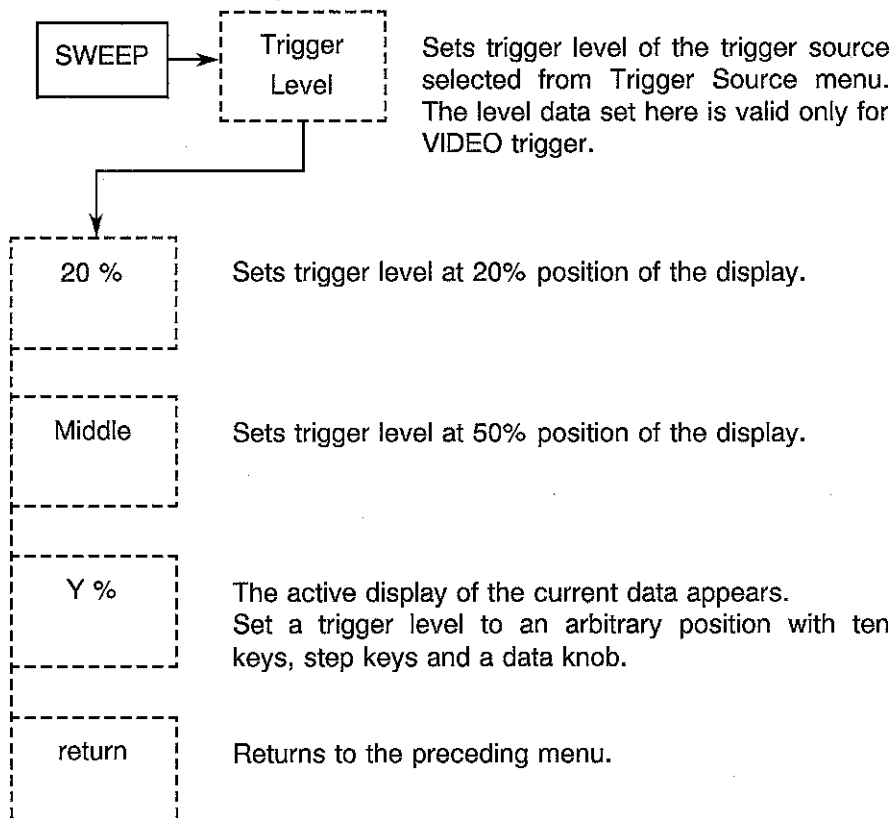
**● Explanation of Trigger Level Menu**

4. Functions of SWEEP Mode

"▶" is appeared on the scale of the left side of the screen to show the

position of the trigger when the keys of 20%, Middle, and Y% are pressed. The trigger level can be set by the data

knob, the step key and the ten keys.

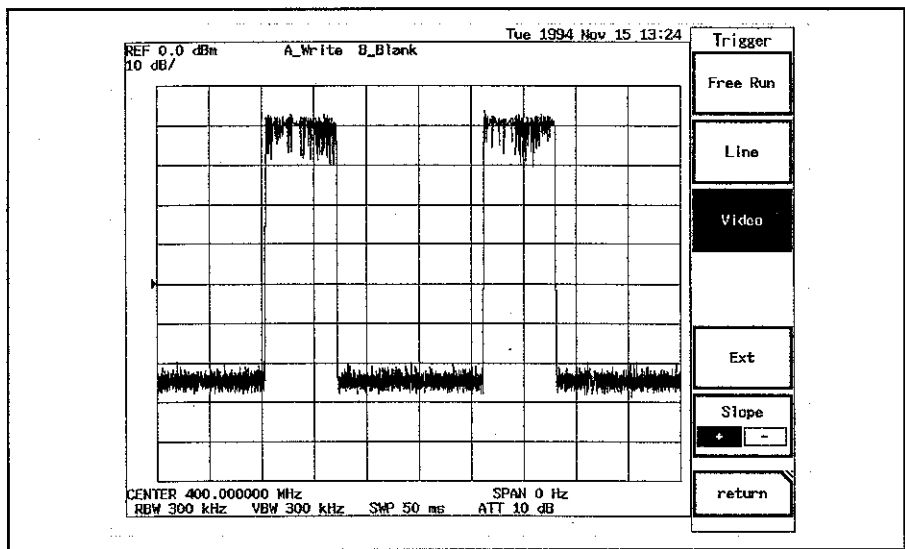

Figure 7-20 Trigger is made at the waveform being displayed

■ Explanation of START Lamp (LED)

In the case that "Trig Source" is in the Free Run setting, the START lamp is turned on when the sweeping begins and it is turned off when the sweeping stops except in the case of Free Run setting. During the gated sweeping, it is turned on during the gate is on and it is turned off when the sweeping is stopped.

## ■ Sweep Time

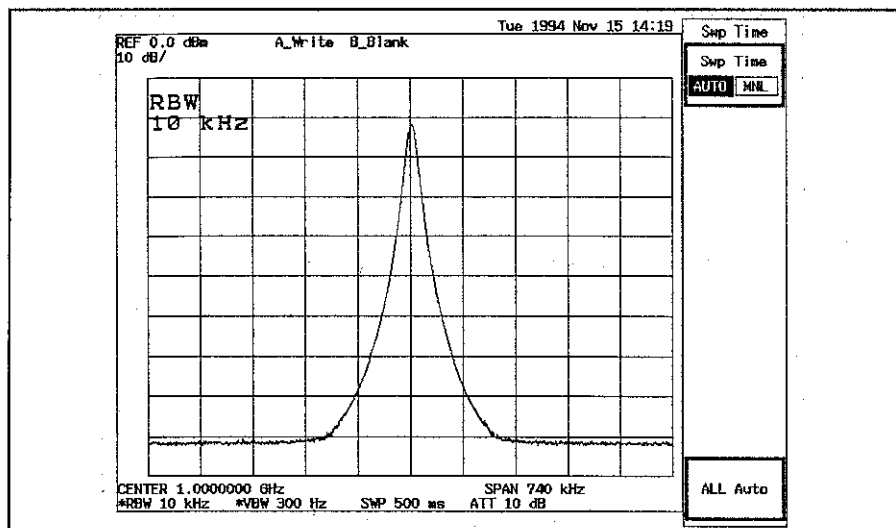

Figure 7-21 SWP = AUTO (500 ms)

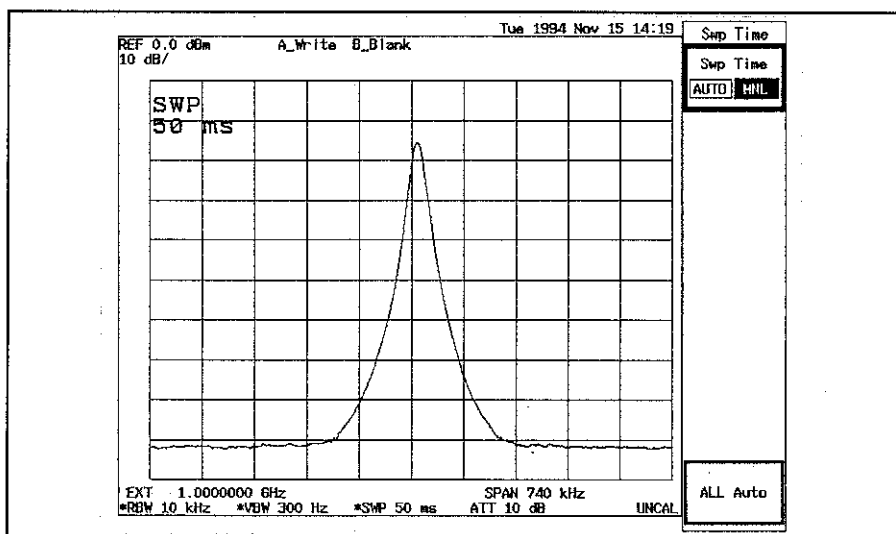
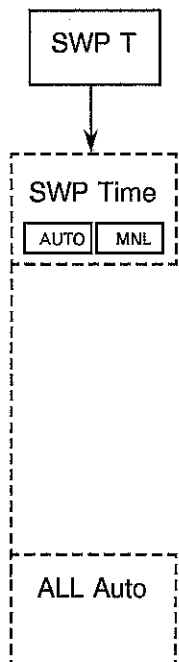

Figure 7-22 SWP = 50 ms

When sweep is too fast to display the signal (setting time of the filter), the level display has a error and the UNCAL message appears on the center of the screen. In this case, increase the sweep time.

● Sweep Time Setup Menu



SWP can be set between 50ms and 1000s. (Waveform of Transient mode is between 50μs and 2s.) At AUTO initializing, sets the range automatically depending on for Frequency span, RBW, VBW, etc. Relationship among frequency span, RBW, VBW and SWP in AUTO setting

$$\text{Frequency span} / \{ \text{RBW} \times \text{Min}(\text{RBW}, \text{VBW}) \times 0.5 \} = \text{SWP}$$

Pressing this softkey sets all coupled functions (RBW, VBW and SWEEP TIME) to AUTO mode with a reference of the current span setting.

■ Sweep Mode Switching

SINGLE

Forcibly resets the sweeping even if it is in progress, and stops sweeping until the next pressing of this key. In the case the trigger condition is Free Run, sweep is performed once at the time of pressing this key. In the other case, sweep is performed once if the trigger condition is satisfied after pressing of this key. If this key is used to execute MEASUREMENT function, the specified measurement is executed once.

START  
REPEAT  
STOP

Switches the sweep mode to Continuous or Stop. When START is set, sweep is performed continuously in the trigger condition of Free Run. In the case of the other trigger condition, sweep is performed at every time the trigger condition is satisfied. When STOP is set, sweeping is reset even if it is in progress. If this key is used to execute MEASUREMENT function, the specified measurement is executed repeatedly.



## 5. Functions of MEASUREMENT Section

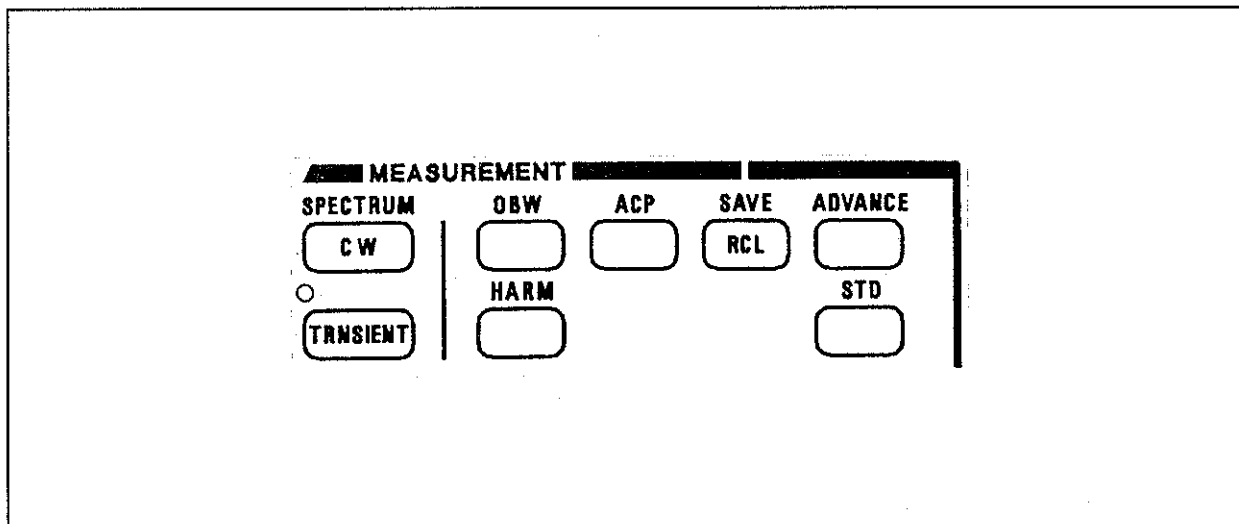

Figure 7-23 Panel Keys in MEASUREMENT Section

### ■ Explanation of OBW (Occupied Bandwidth) Key

Pressing  key enters OBW measurement mode, halting sweep.

This is the condition waiting for OBW measurement related parameters being input or measurement start command being input.

When currently set parameters need not be changed, press  or  key to start measurement.

When measurement has been started with  key, measurement is continued after the end of a measurement.

When measurement has been started with  key, operation stops after the end of a measurement.

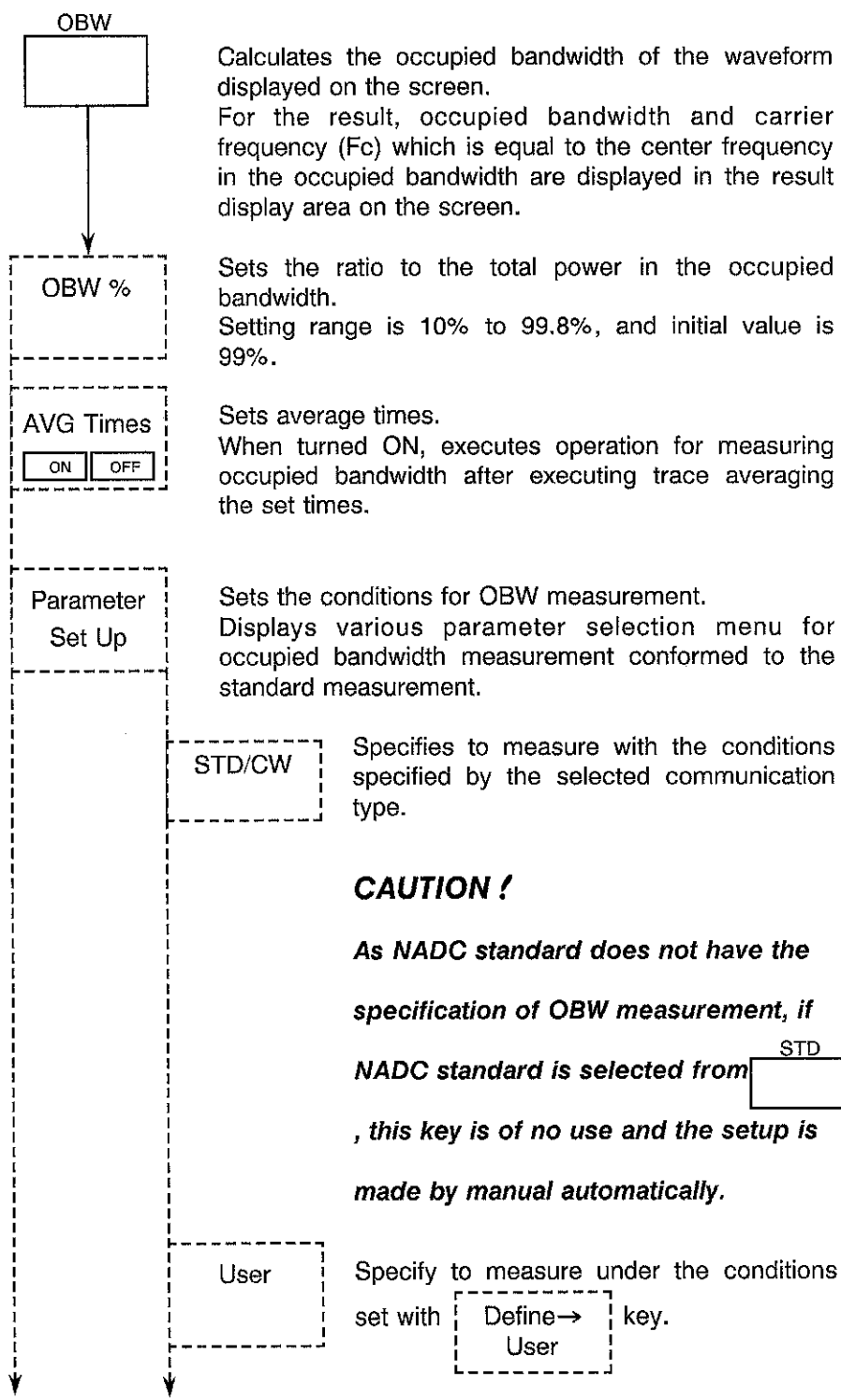

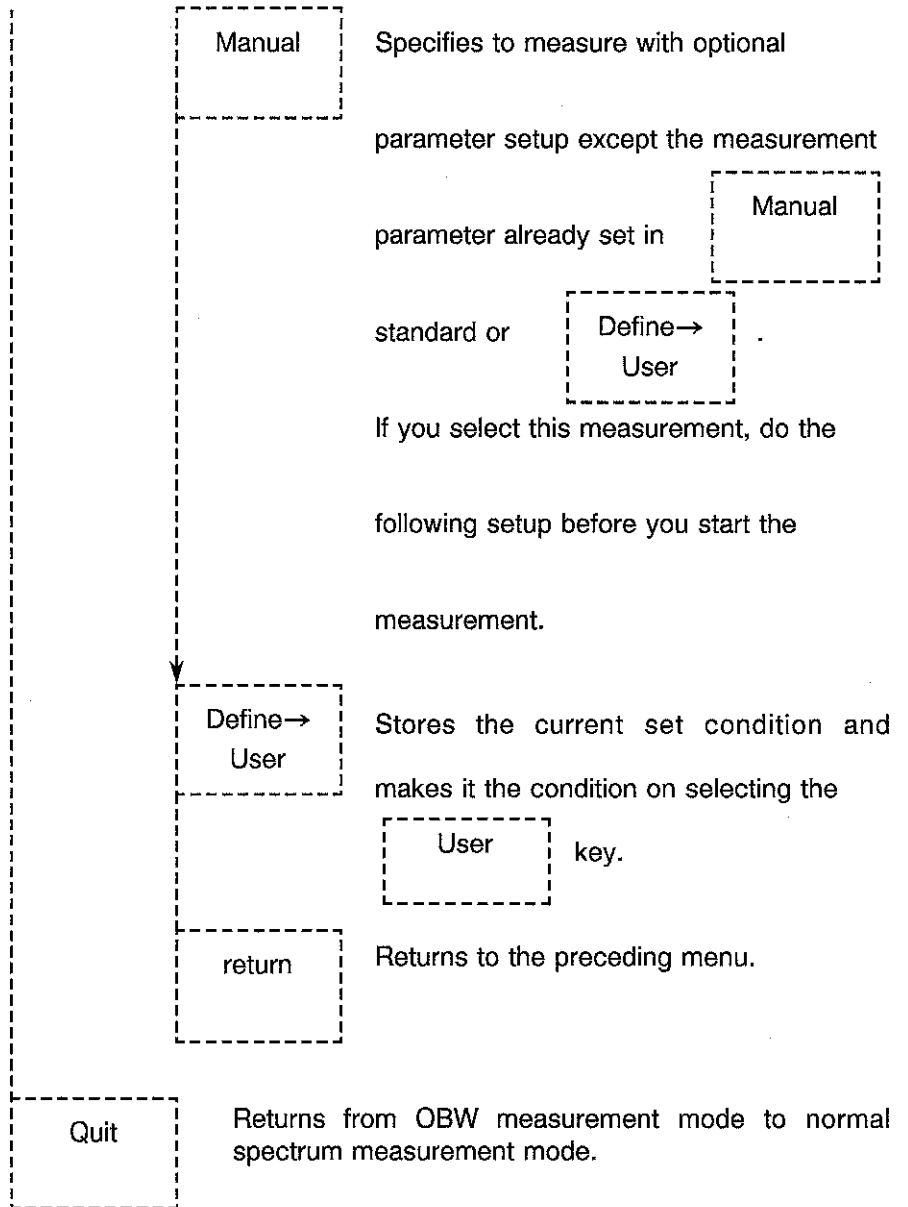

### ■ Explanation of ACP (Adjacent Channels Leakage Power) Key

Pressing <sup>ACP</sup> key enters ACP measuring mode, halting sweep.  
When

currently set parameters need not be changed, press  REPEAT or  SINGLE key to start measurement.

When measurement has been started with  REPEAT key, measurement is continued after the end of a measurement.

When measurement has been started with  SINGLE key, operation stops after the end of a measurement.

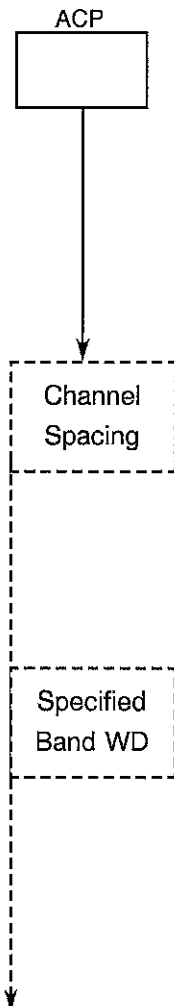

Calculates the total power from measured data displayed on the screen, and integrates power in specified bandwidth to obtain the ratio to the total power.

For out-of-spec measurement, 2 measuring methods are available: "Full mode" to measure based on the measured data which is displayed on a single screen and "Sepa mode" to measure based on the data obtained by dividing screen for specified channel and upper and lower channels.

Sets the distance between channels.

**CAUTION !**

*When STD/CW is selected from Parameter Set Up menu, the channel spacing of specified standard is displayed.*

*Now the channel space can be changed, but the standard channel space is reset by pressing STD/CW key.*

Sets specified bandwidth.

**CAUTION !**

*When STD/CW is selected from Parameter Set Up menu, the standard bandwidth of specified standard is displayed.*

*Now the standard bandwidth can be changed, but the standard channel space is reset by pressing STD/CW key.*

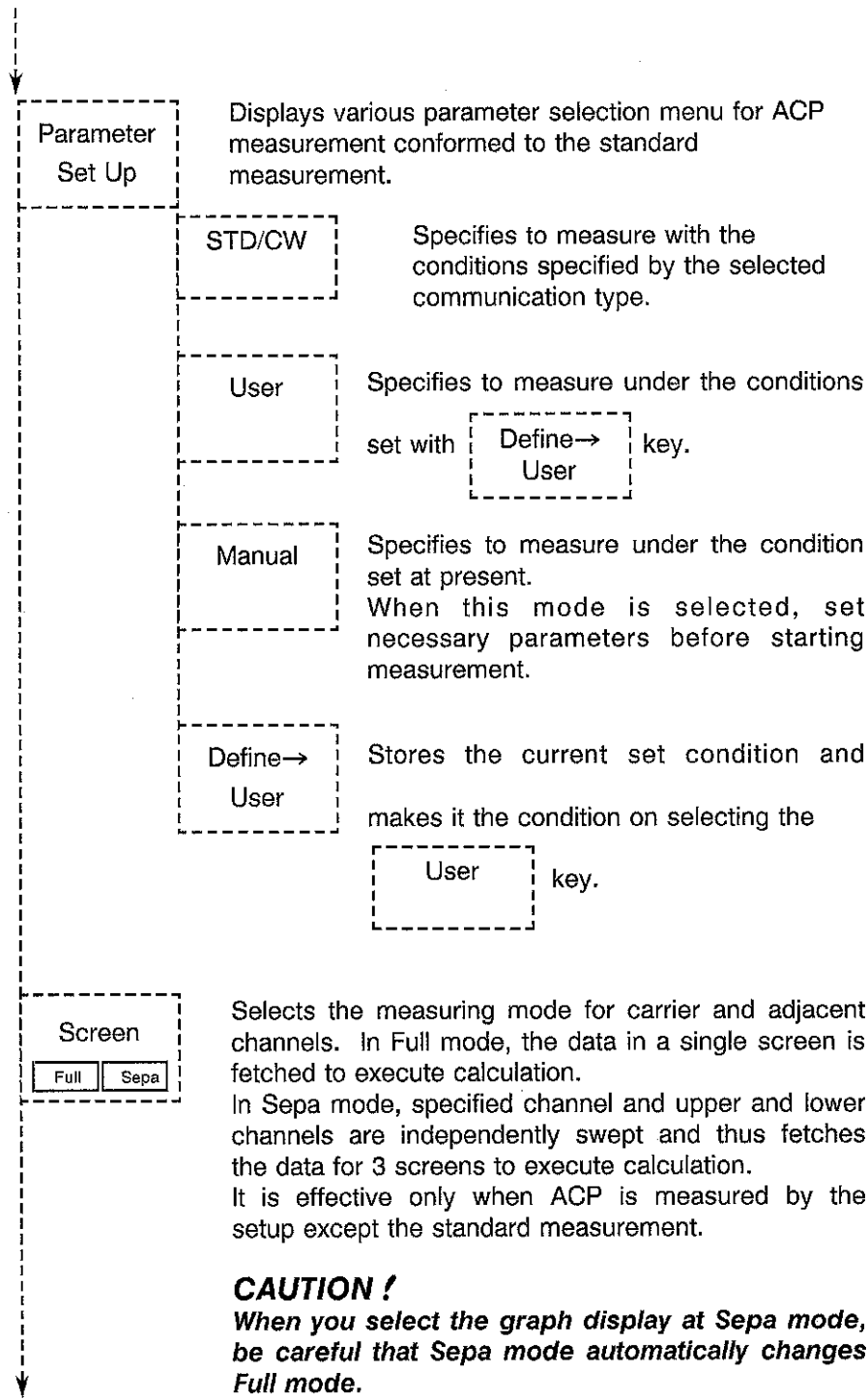

5. Functions of MEASUREMENT Section

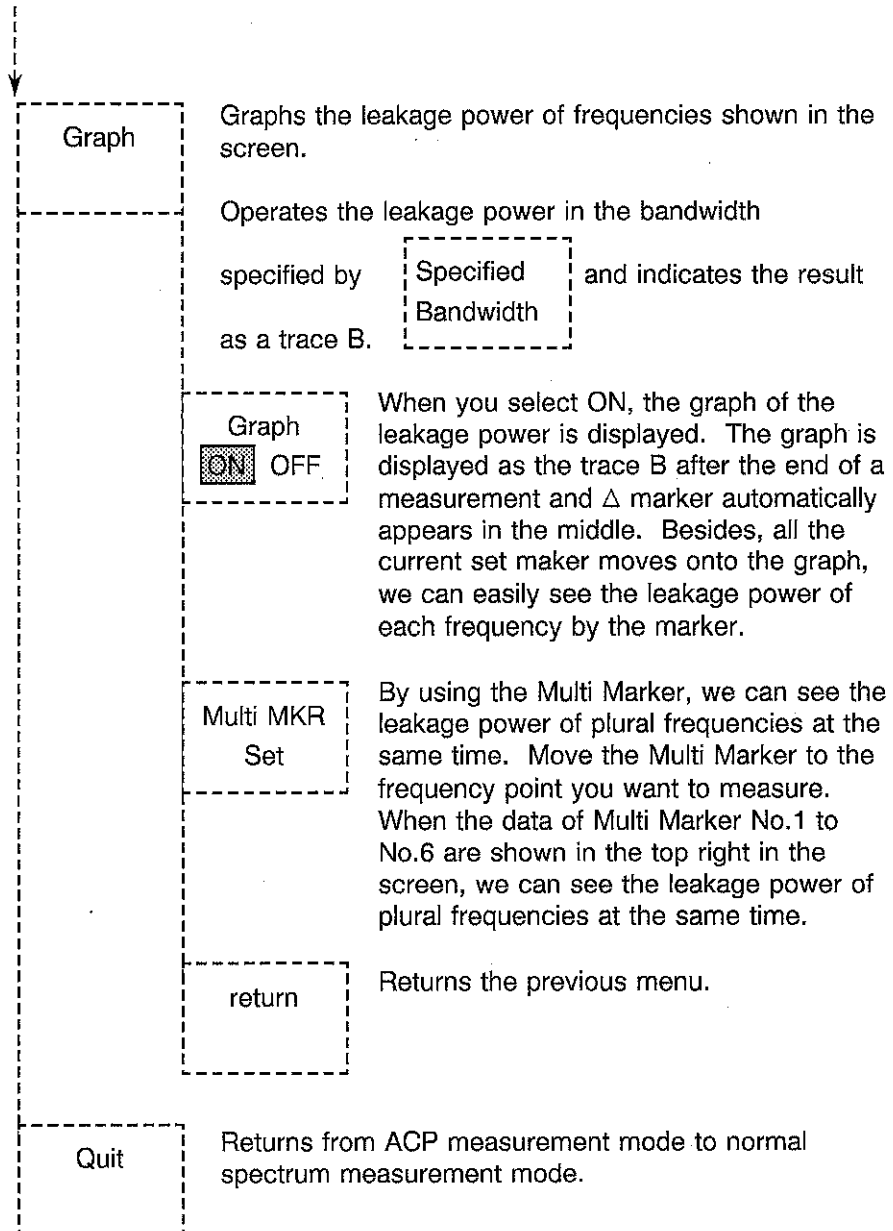

## ■ HARMONICS (higher harmonics) measuring function

Pressing  key enters higher harmonics measuring mode, halting sweep.

Entering higher harmonics measuring mode automatically sets start/stop frequency according to the parameters preset at selecting the mode.

When currently set parameters need not be changed, press  or  key to start measurement.

When measurement has been started with  key, measurement is continued after the end of a measurement.

When measurement has been started with  key, operation stops after the end of a measurement.

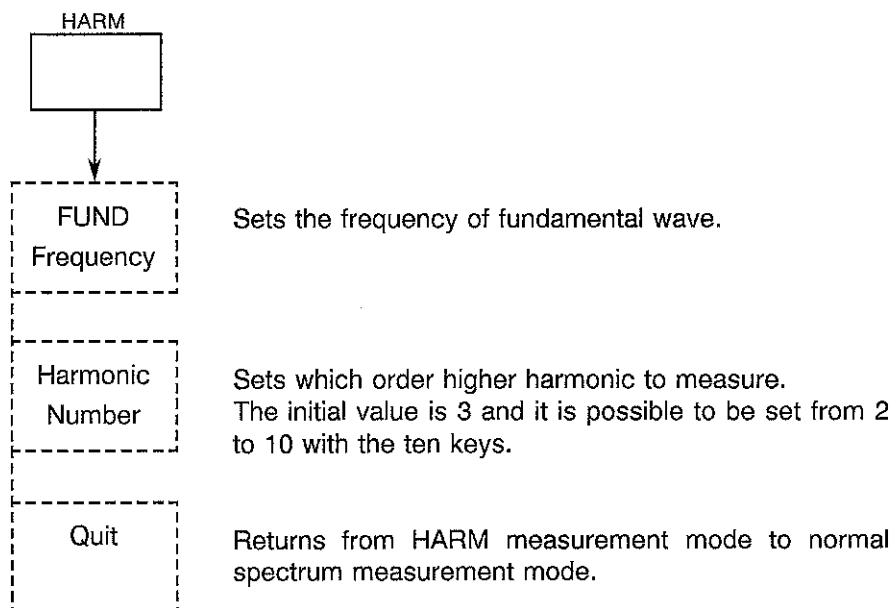

### ■ Function of CW key

This key is used analyzing continuous wave signal by conventional spectrum analysis.

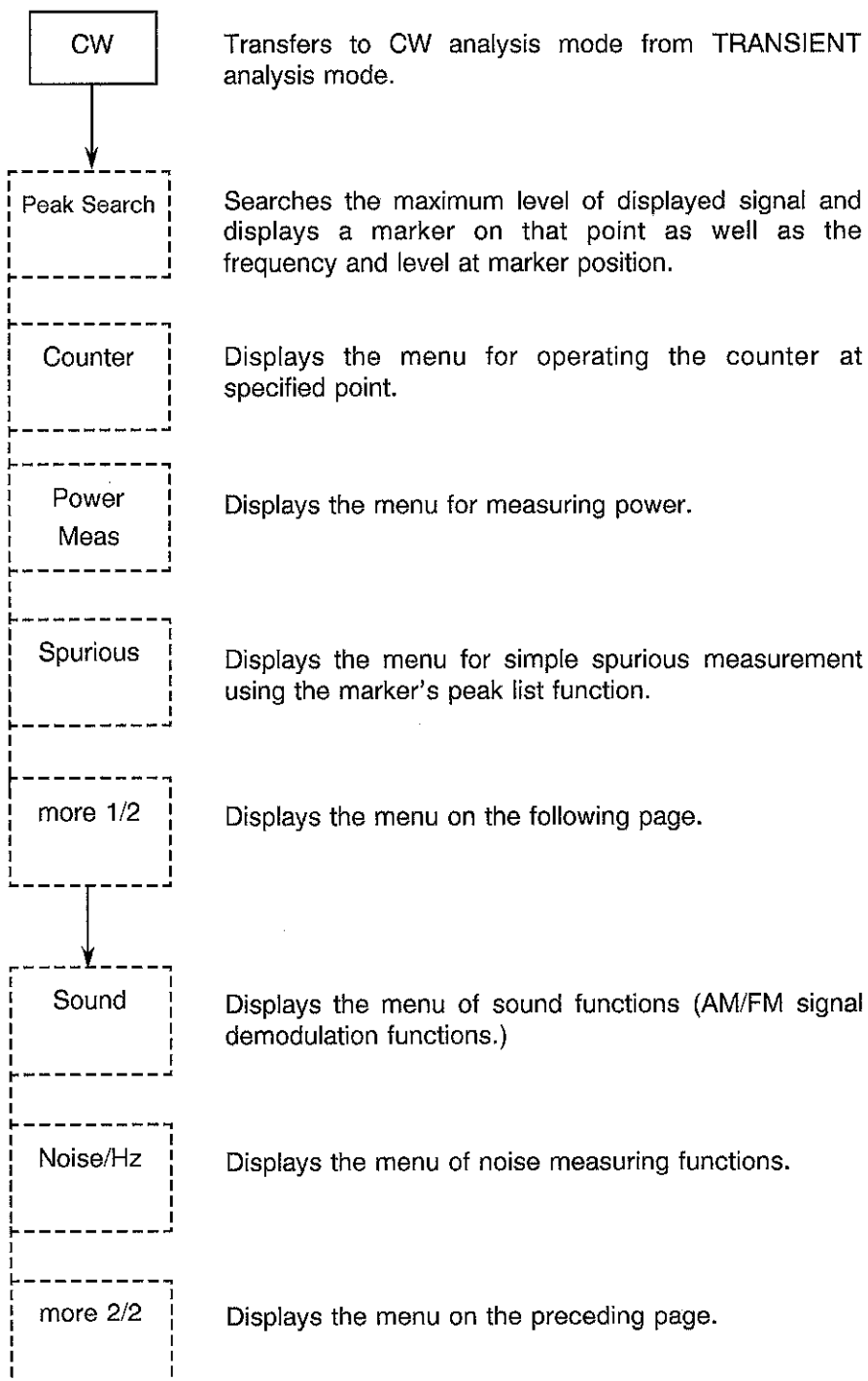



● **Counter function**

Counter function accurately measures the frequency of signal at a point where the marker is positioned. This function measures not the frequency of the marker itself but the frequency of the signal on which the marker is positioned. Therefore, it is unnecessary to move the marker on the peak of spectrum. However, displayed amplitude value corresponds to the marker position.

In normal marker mode, the frequency for marker position is displayed by calculating the marker position on frequency axis from center frequency. On the other hand, in counter mode, the frequency is directly measured with the frequency reference accuracy.

With software menu maximum 1 Hz resolution can be set. Increasing the resolution of the counter leads to longer gate time and longer sweep time.

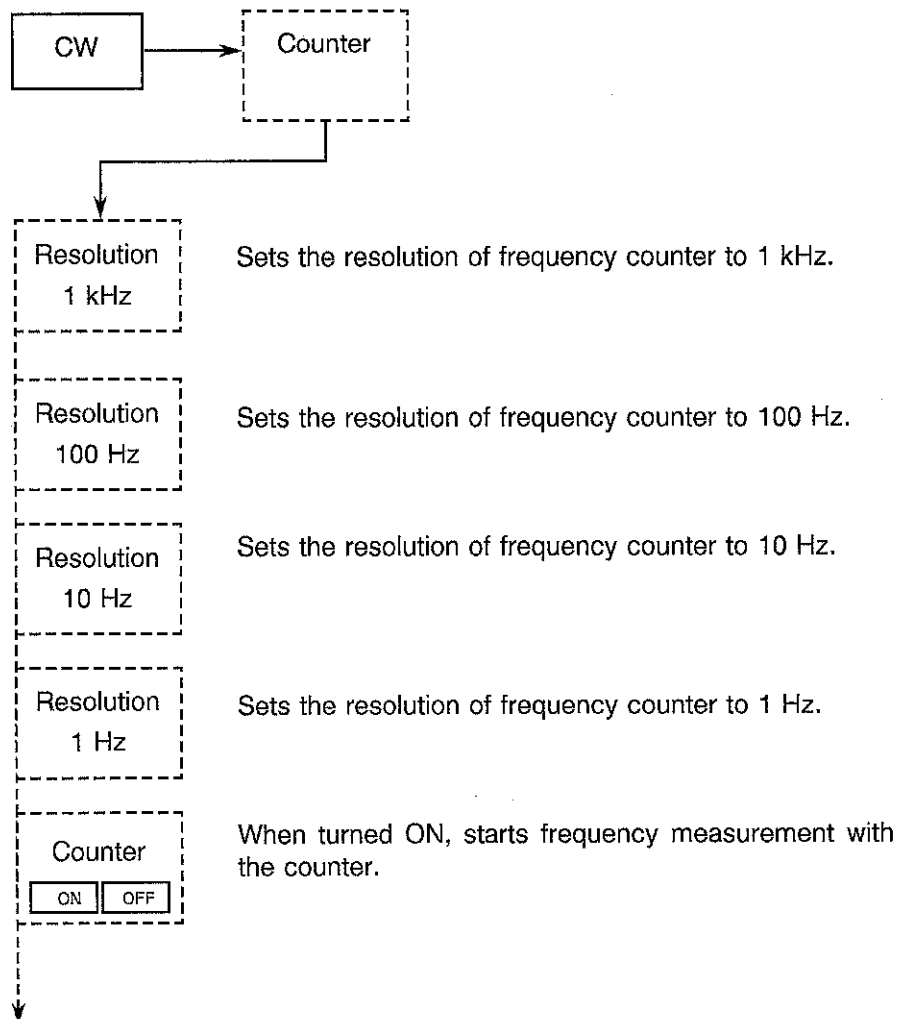

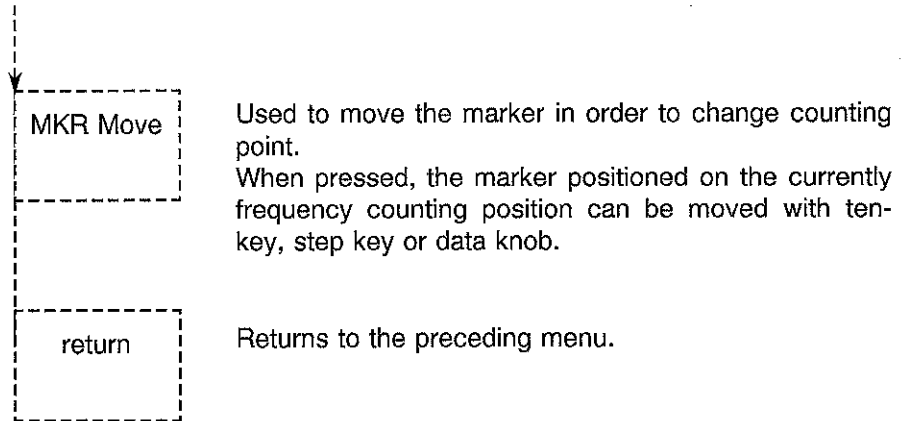

**CAUTION !**

1. *In the following cases, frequency counter mode may not display correct value.*
  - *When span > 1 GHz*
  - *When the difference in noise level from marker point value is 25 dB or less*
2. *Frequency counter mode cannot be used with SIGNAL TRACK mode.*

● Measurement of power

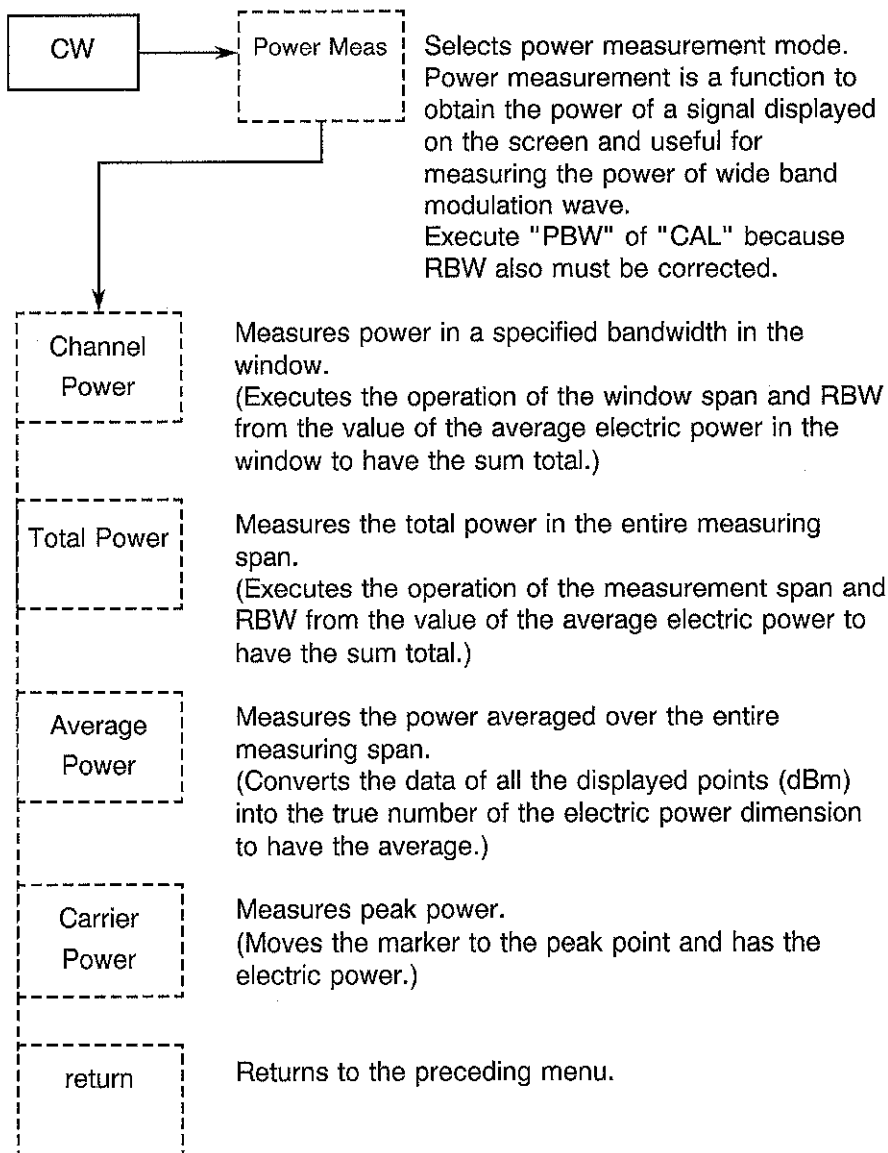

● Spurious measurement

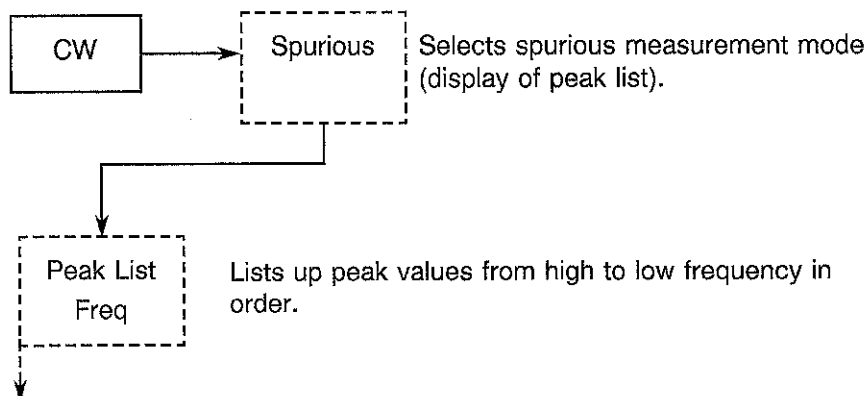

5. Functions of MEASUREMENT Section

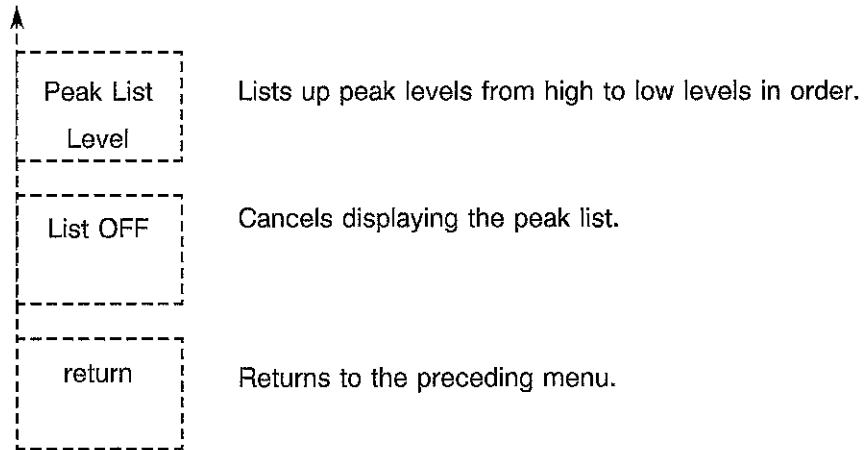

● Sound function

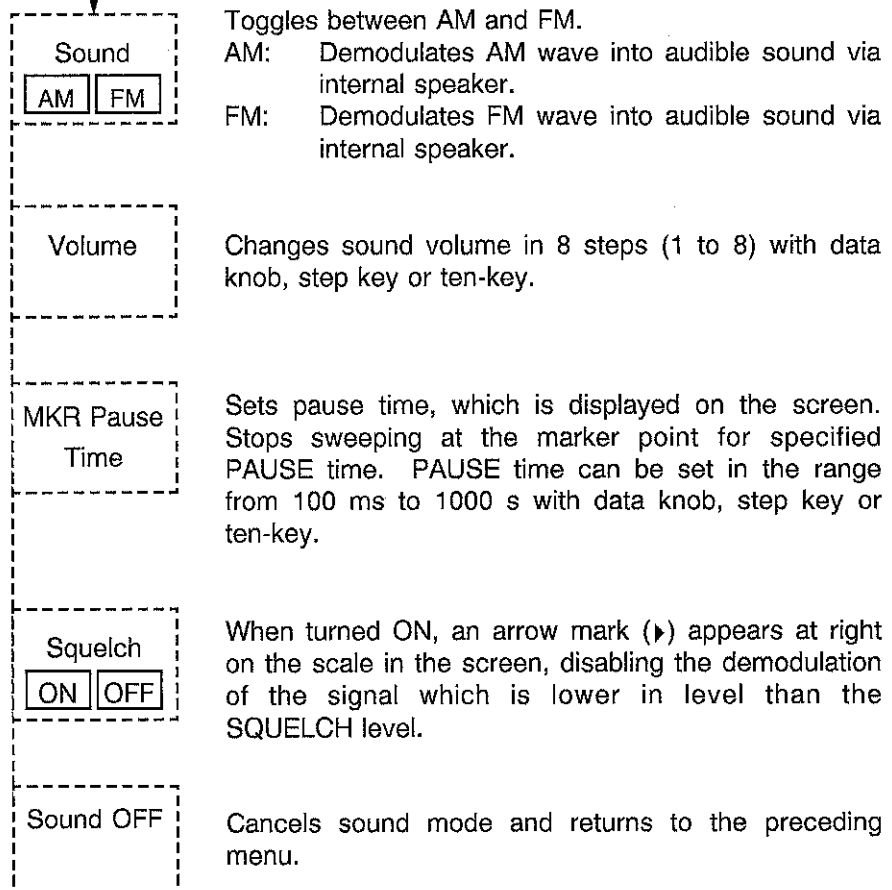
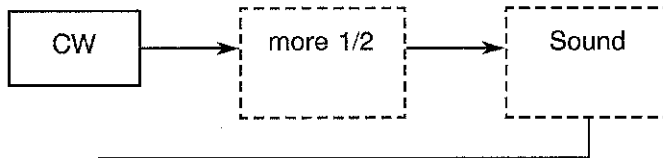

● Noise/Hz measurement

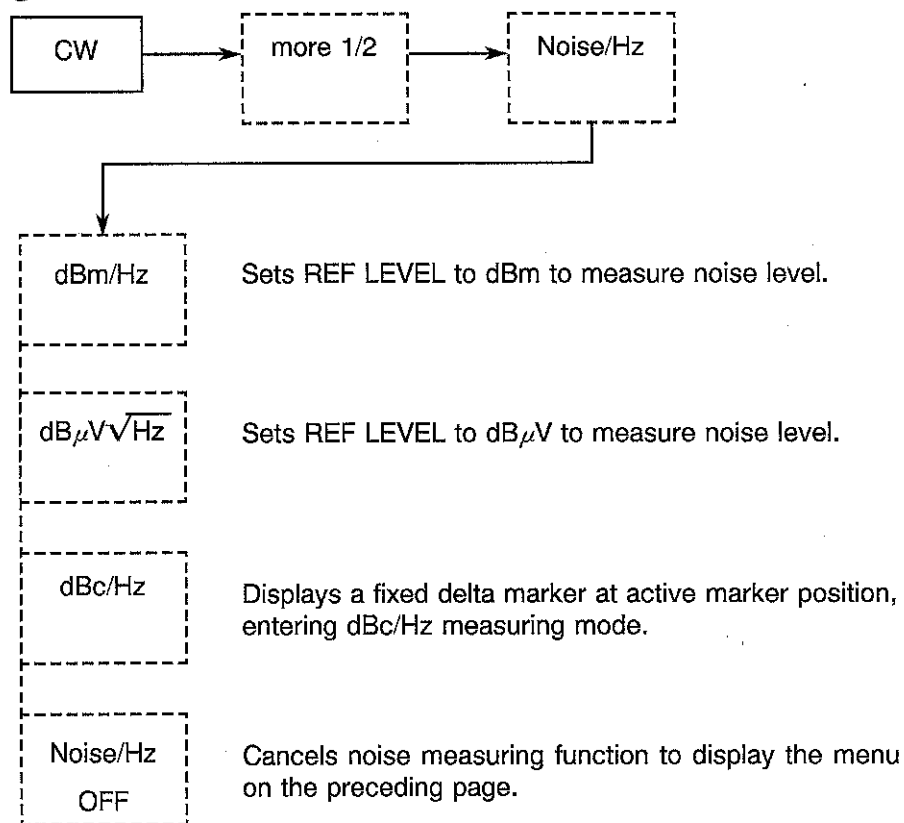

■ **Function of TRANSIENT key**

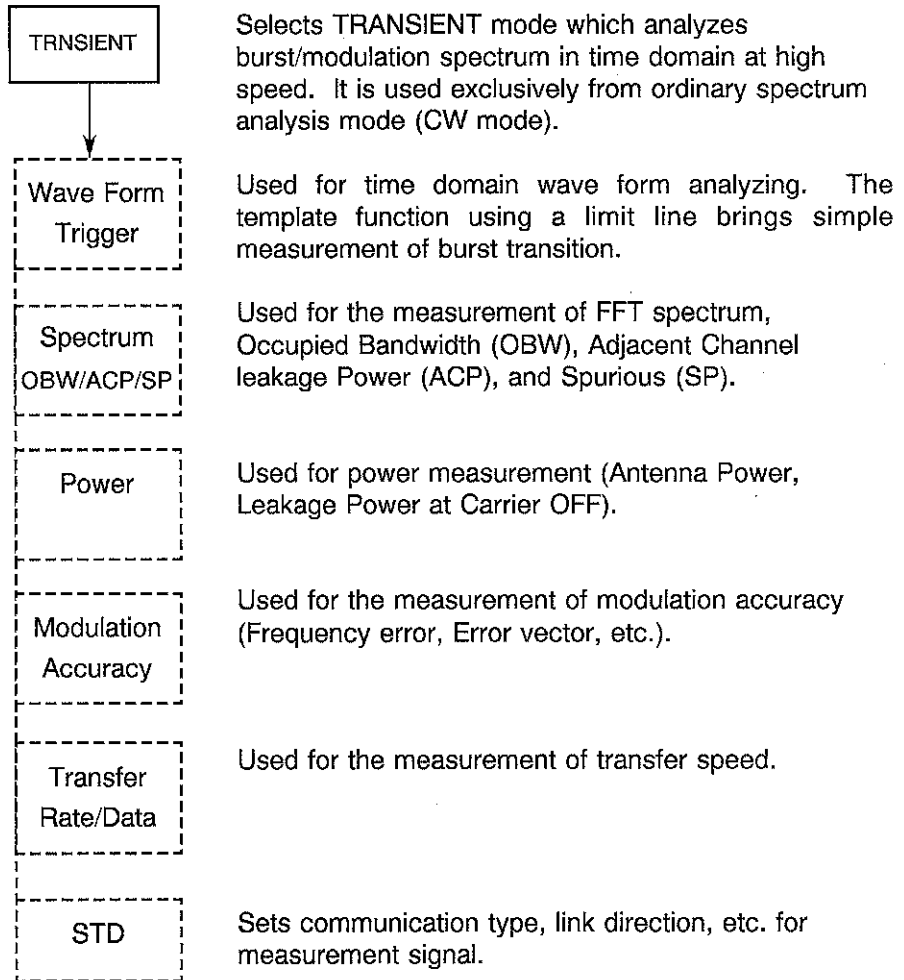

**CAUTION !**

*In TRANSIENT mode, soft key is used for operation basically. The following keys which can be used for ordinary spectrum measurement (CW mode) cannot be used.*

**OBW, ACP, HARM, SPAN, SWEEP, INPUT  
SCREEN A/B/C/D, FORMAT, WINDOW  
→CF/→RL**

*Also the following keys are limited to use only for the setup (the corresponding soft key menu is not displayed) with numerical value, knobs, and arrow mark keys.*

**FREQ, LEVEL, ATT (\*)  
(\*): ATT can be used only when the setup is MNL.**

*Now SINGLE/REPEAT keys are used for the start/stop in each measurement. (When the measurement item is changed, the measurement always stops.)*

● Time domain wave form analyzing function

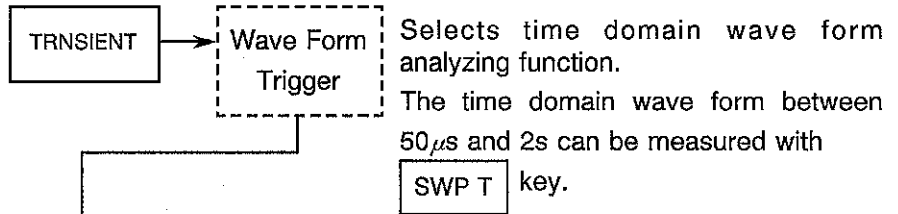

A template meeting each specification is automatically displayed and the Pass/Fail test of the burst waveform starts.

**Note:** When the limit line is off or a user-defined limit line is selected without any user-defined table data, a template is not displayed.

The transition and level of time domain waveform do not necessarily coincide with the standard template's (limit line's) value. For an effective usage of this function, adjust both the burst waveform and the horizontal (X-axis) and vertical (Y-axis) position of the template.

"Shift X" of "Trigger Position" or "Limit Line" is useful for the horizontal adjustment and "Shift Y" of "Limit Line" is useful for the vertical adjustment.

Once this setting is completed, you can measure without this adjustment.

If the standard (PDC/PHS/NADC) is changed, however, it is necessary to adjust them and RBW again.

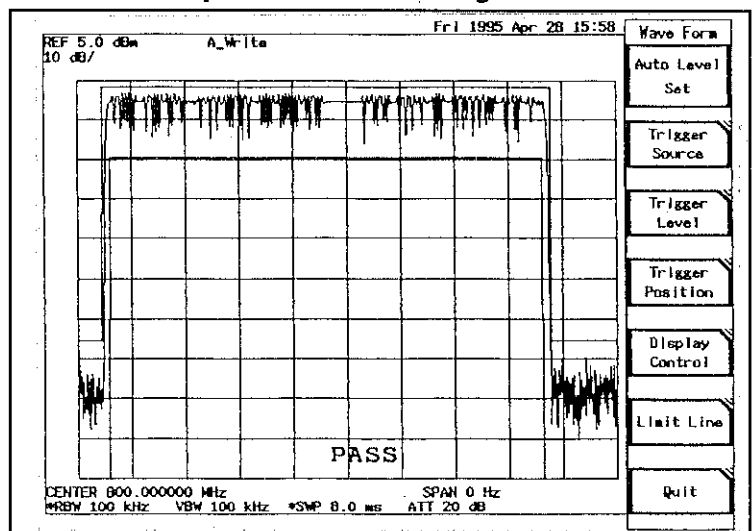
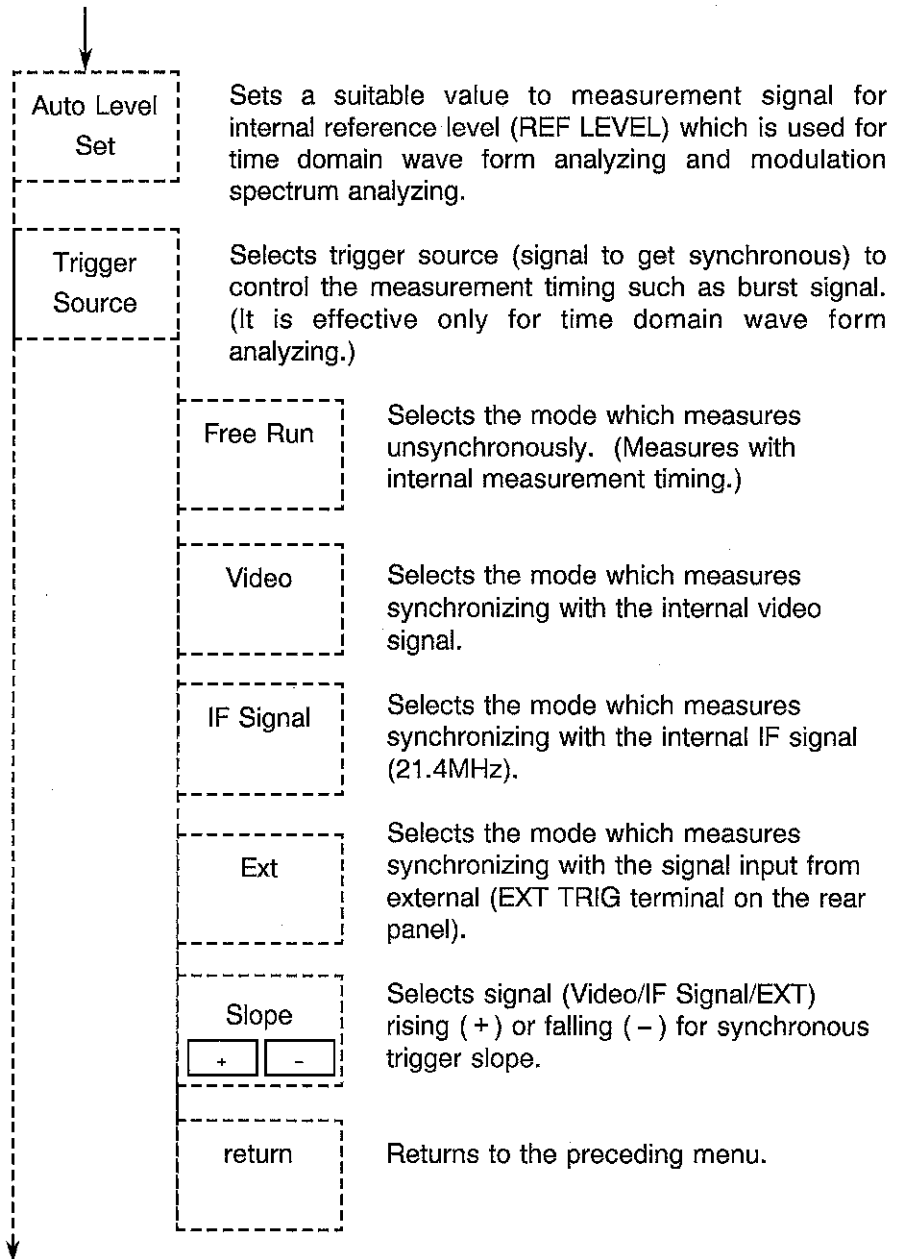
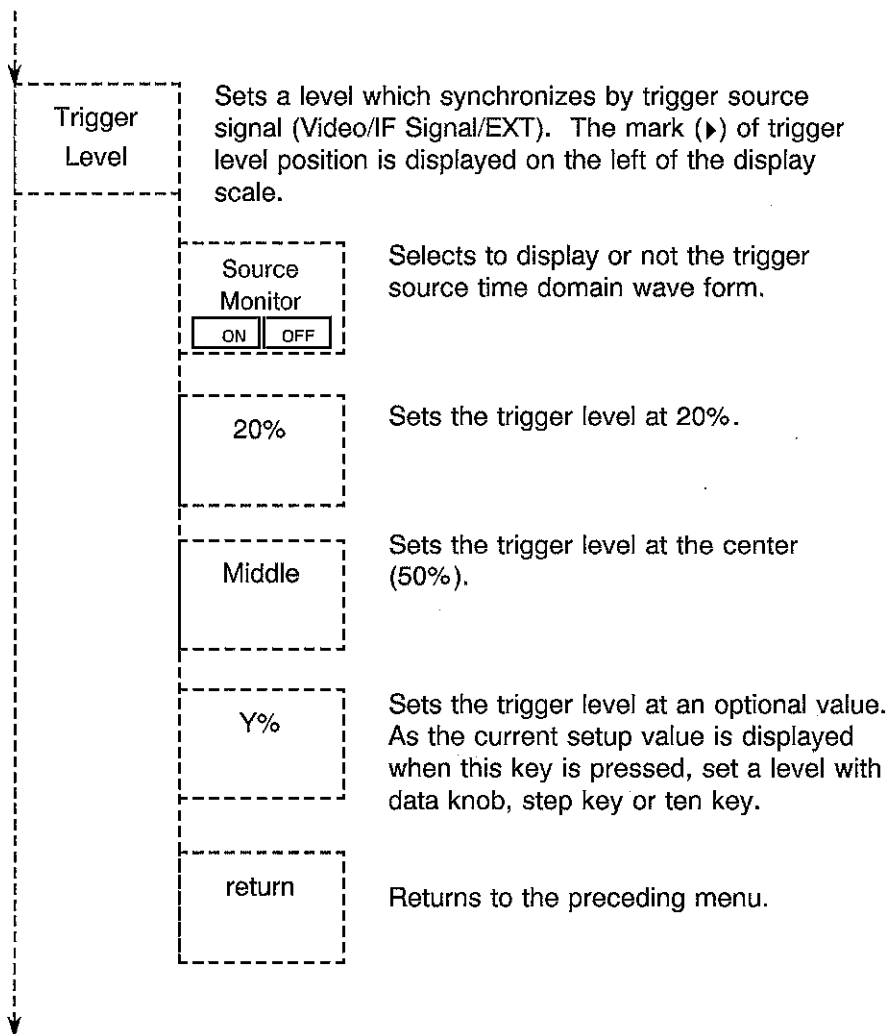

Figure 7-24 Time domain wave form measurement screen

5. Functions of MEASUREMENT Section







5. Functions of MEASUREMENT Section

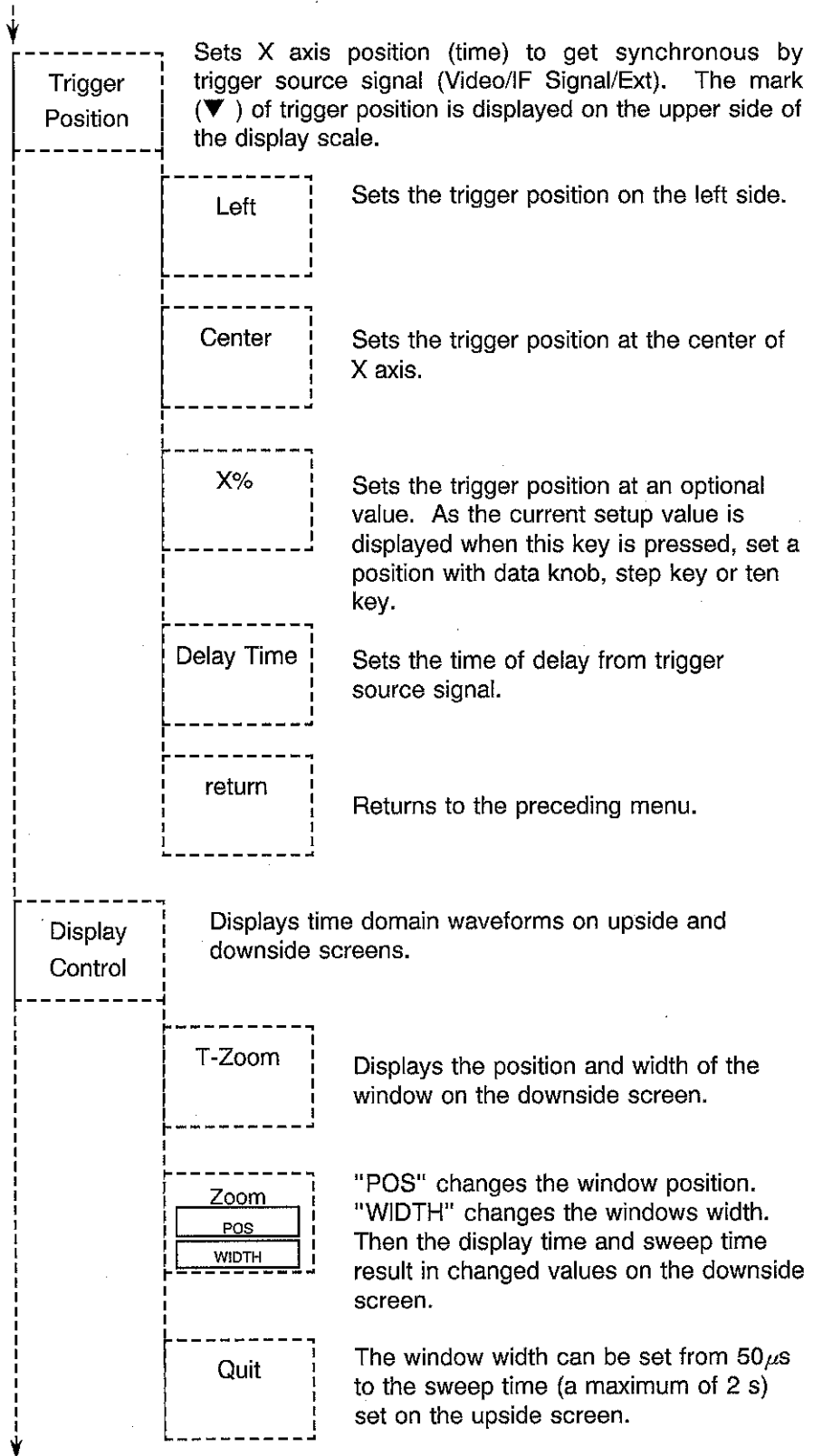

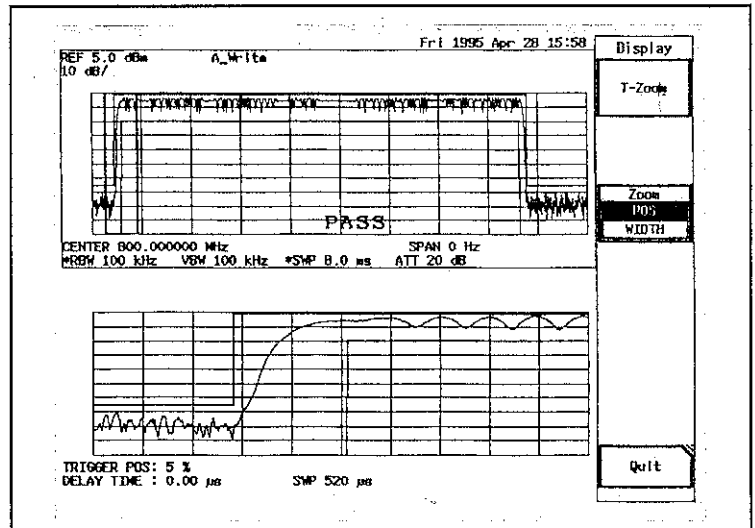
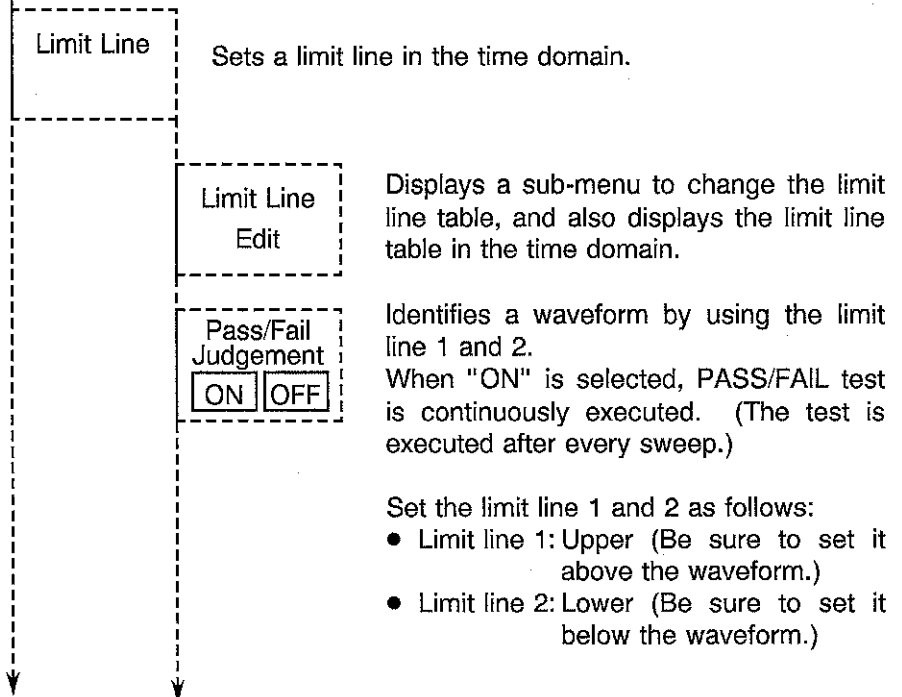

Figure 7-25 Time domain wave form measurement screen (dual screen)



PASS/FAIL test

- (1) Pass conditions
- When the limit line 1 and 2 is displayed, all measuring points of a waveform must be between the upper and lower level.
  - When only the limit line 1 is displayed, all measuring points of a waveform must be below the upper level.
  - When only the limit line 2 is displayed, all measuring points of a waveform must be above the lower level.
  - If no limit line is set, the measurement passes.
  - Measuring points pass on the limit line.

- (2) Failure conditions  
 A measuring point causes failure if it exceeds the limit line. (If pass condition is not satisfied, the measurement fails.)

- (3) Case of using Zoom window  
 When Zoom window is displayed with Display Control key, PASS/FAIL test is executed only for the window.

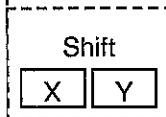

Shift the time data (X) or the level data (Y), that are already set.

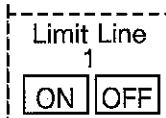

Switches the limit line 1 to ON/OFF.

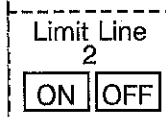

Switches the limit line 2 to ON/OFF.

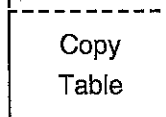

Displays a menu for coping data tables of limit lines.

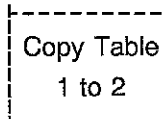

Copies a data table of limit lines for 1 to 2.

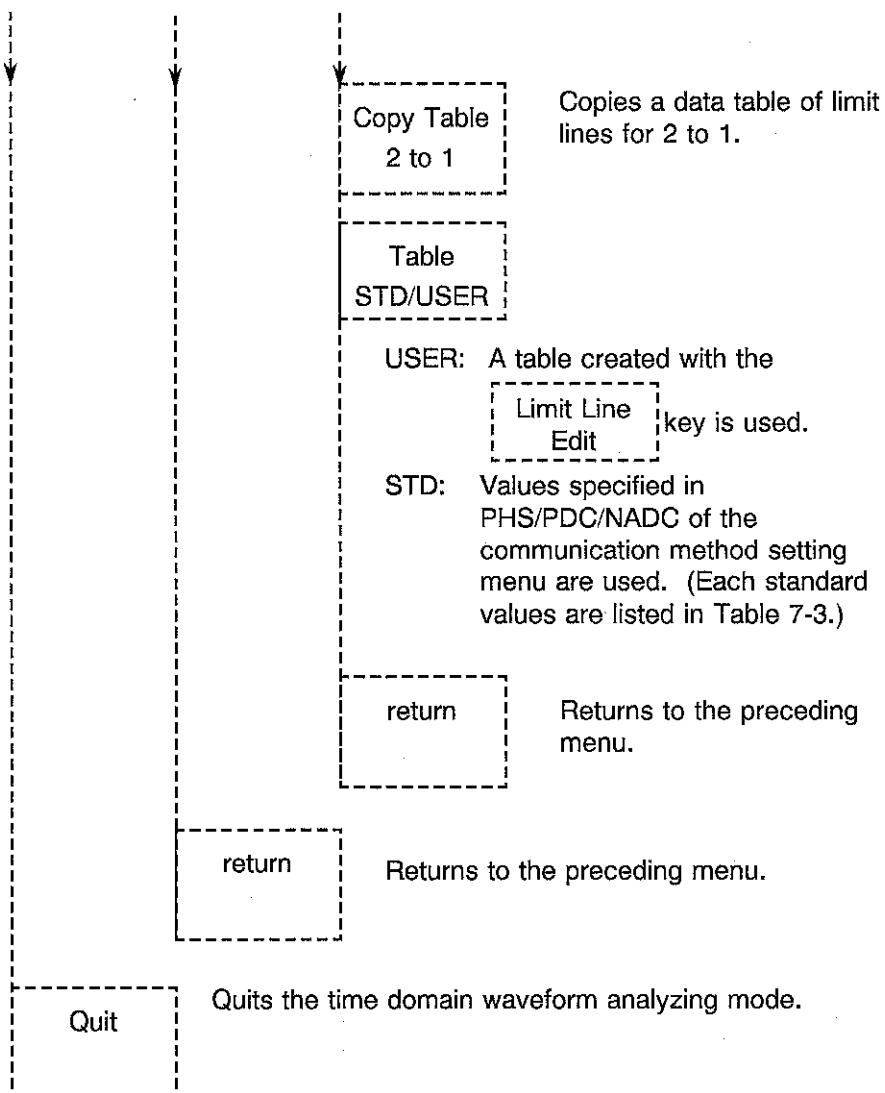

Table 7-3 Standard values

When STD is selected from STD/USER, select values from the following on the basis of a standard (PDC/PHS/NADC) selected from the standard menu.

PDC upper limit line						
	(1)	(2)	(3)	(4)	(5)	(6)
time	-5.0s	0.15ms *1	0.15ms *1	6.817ms *2	6.817ms *2	5.0s
level	-30.0dBm	-30.0dBm	34.0dBm	34.0dBm	-30.0dBm	-30.0dBm
PDC lower limit line						
	(1')	(2')	(3')	(4')	(5')	(6')
time	-5.0s	0.269ms *3	0.269ms *3	6.698ms *4	6.698ms *4	5.0s
level	-200dBm	-200dBm	16.0dBm	16.0dBm	-200dBm	-200dBm
PHS upper limit line						
	(1)	(2)	(3)	(4)	(5)	(6)
time	-5.0s	0.02ms	0.02ms	0.619ms	0.619ms	5.0s
level	-37.0dBm	-37.0dBm	23.0dBm	23.0dBm	-37.0dBm	-37.0dBm
PHS lower limit line						
	(1')	(2')	(3')	(4')	(5')	(6')
time	-5.0s	0.033ms	0.033ms	0.606ms	0.606ms	5.0s
level	-200dBm	-200dBm	5.0dBm	5.0dBm	-200dBm	-200dBm
NADC upper limit line						
	(1)	(2)	(3)	(4)	(5)	(6)
time	-5.0s	0.2ms	0.2ms	6.866ms	6.866ms	5.0s
level	-30.0dBm	-30.0dBm	33.0dBm	33.0dBm	-30.0dBm	-30.0dBm
NADC lower limit line						
	(1')	(2')	(3')	(4')	(5')	(6')
time	-5.0s	0.323ms	0.323ms	6.743ms	6.743ms	5.0s
level	-200dBm	-200dBm	10.0dBm	10.0dBm	-200dBm	-200dBm

**Note:** If "RCR-STD27C" is selected from the STD menu, the following values are set.

- \*1 : 0.2ms
- \*2 : 6.867ms
- \*3 : 0.343ms
- \*4 : 6.717ms

● **OBW/ACP/Spurious measurement function**

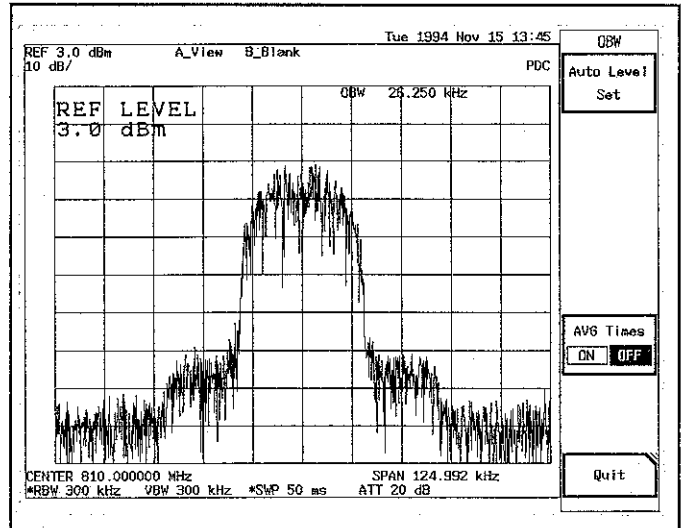
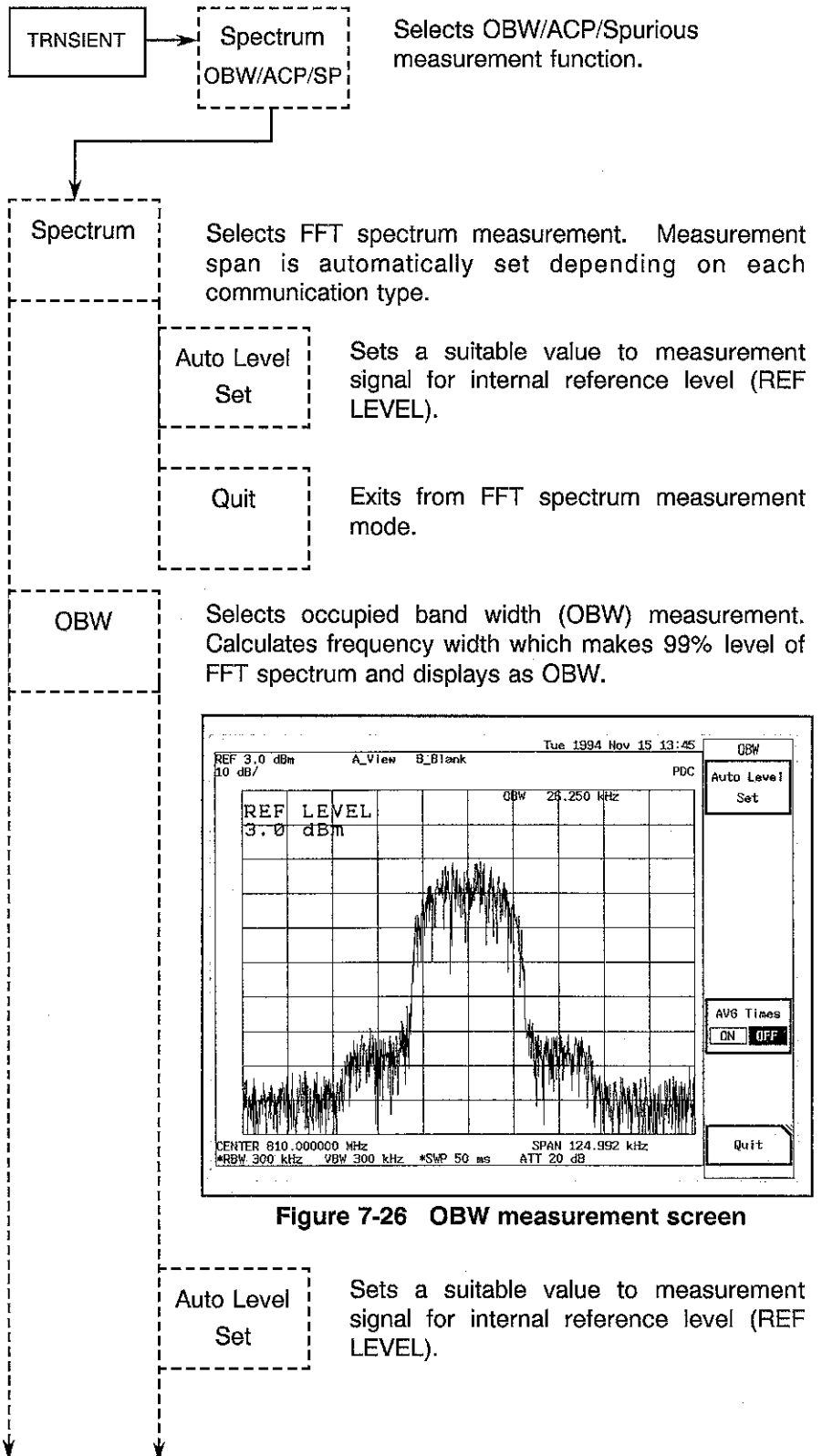
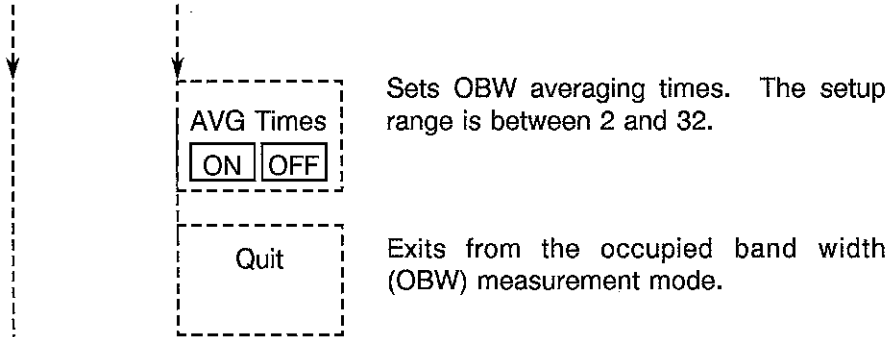

Figure 7-26 OBW measurement screen

5. Functions of MEASUREMENT Section



ACP  
 Selects adjacent channel leakage power measurement. Displays peak power and average power in the bandwidth specified by offset frequency from the carrier specified by each communication type.

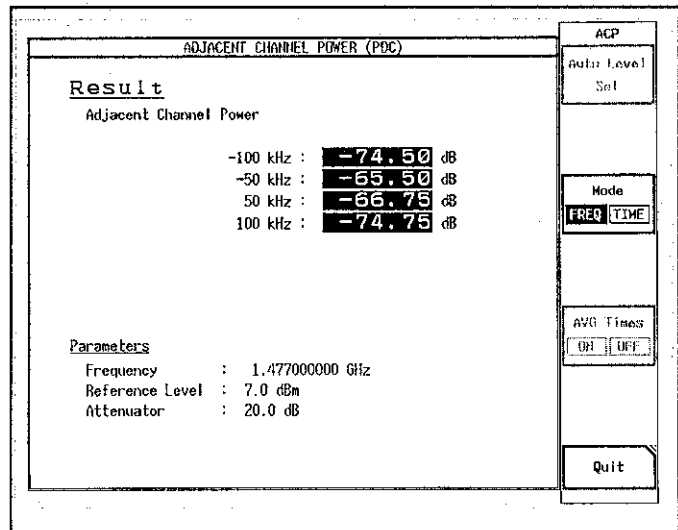
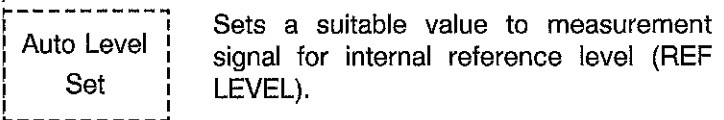

Figure 7-27 ACP measurement screen





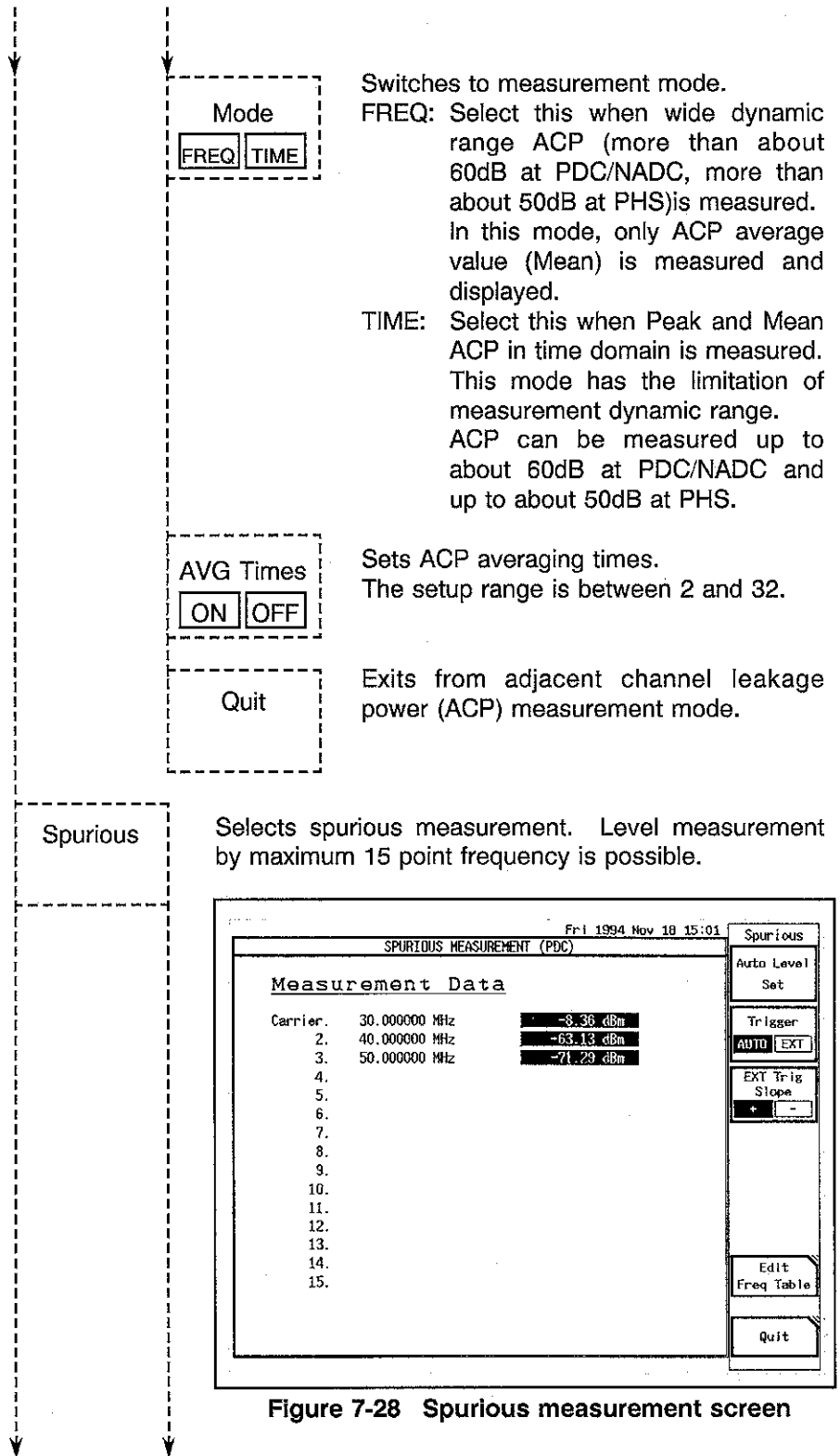
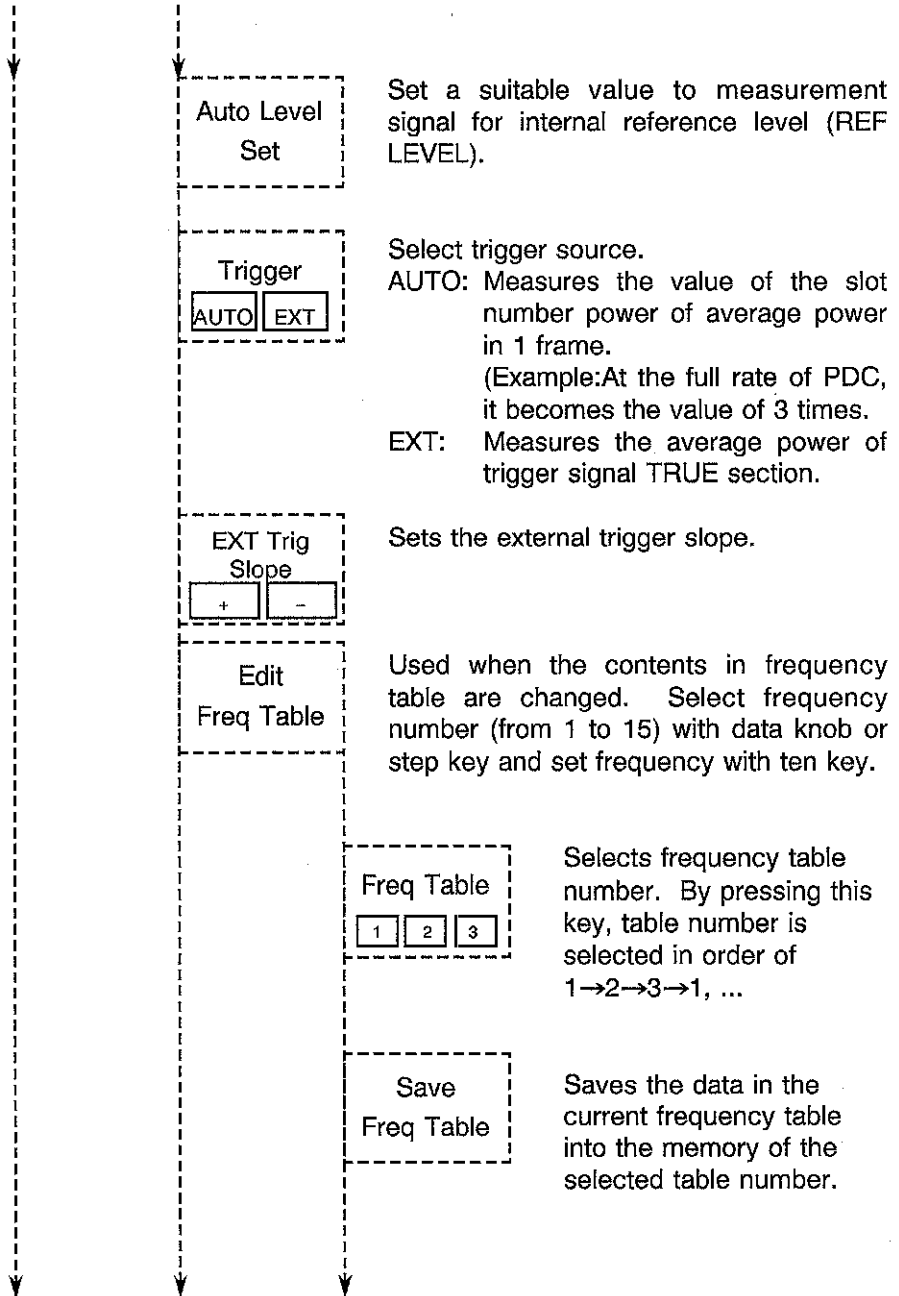
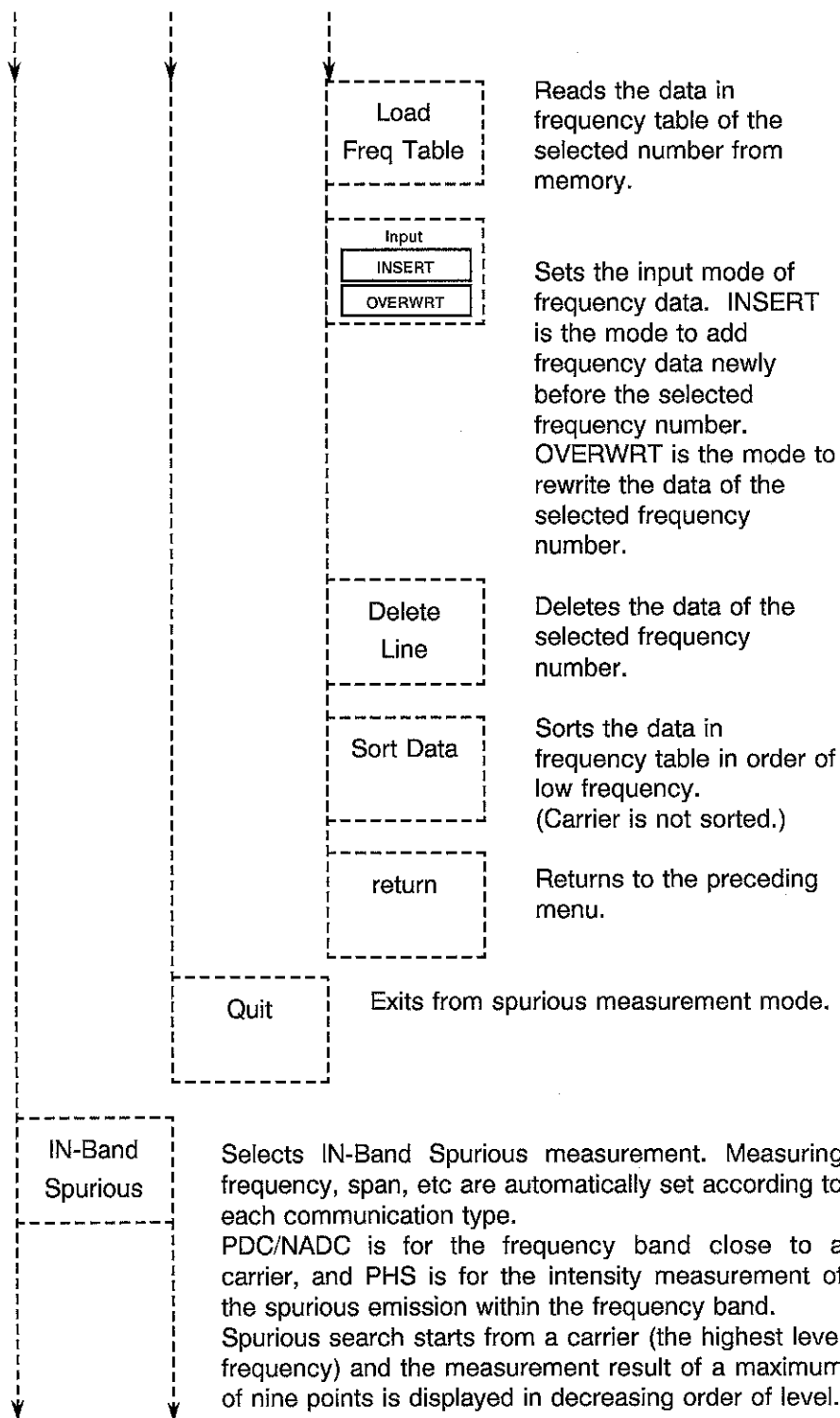

Figure 7-28 Spurious measurement screen

5. Functions of MEASUREMENT Section





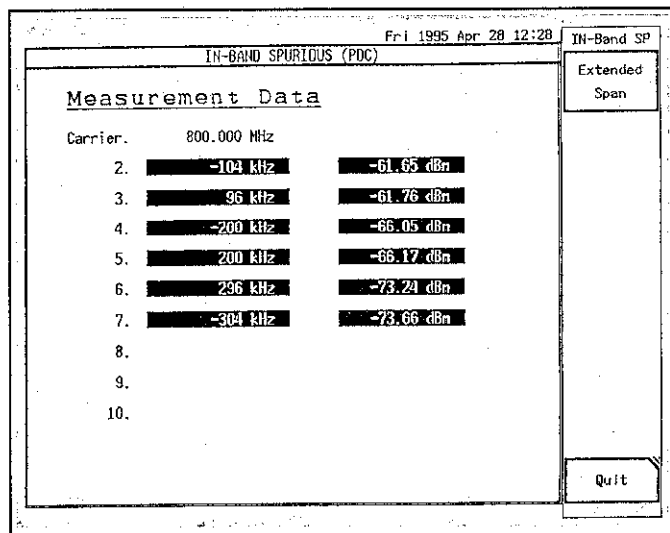

Figure 7-29 IN-BAND Spurious screen

Extended Span

Extends the sweep span.  
 Twice extension span is add to the standard span. The extended span can be set to 0 to 100MHz.  
 When 0Hz is specified, a standard span is used.  
 When the extension span is 0 Hz  
 (PDC/NADC)  
 Sweep span = Standard (2MHz)  
 (PHS)  
 Sweep span = Standard (24MHz)  
 When the extension span is 1.5MHz  
 Sweep span = Standard + 3MHz

Quit

Quits the IN-Band spurious mode.

return

Returns to the preceding menu.

**CAUTION !**

1. Frequency number 1 is always the carrier frequency.
2. Spurious measurement range is -30dBm when Auto Level Set in STD menu is OFF.
3. When signal under measurement is the burst signal, if the sweep span of the extension span is too wide then there may be case where the signal level cannot be measured correctly. Where possible, set the sweep span within the 1MHz.

● **Using "In Band Spurious"**

In "In Band Spurious" mode measurements, the spectrum analyzer first searches for the peaks whose levels are 5.0 dB or higher performing sweeps within a given band, and then displays a list of the frequencies and the levels of those peaks found.

The measurement conditions for each communication system are shown in the table below.

		Sweep Time	SPAN	RBW	VBW
PDC	Uplink	10s (Full rate) 20sec (Half rate)	4MHz	10kHz	3kHz
	Downlink	270ms	4MHz	10kHz	3kHz
PHS	Burst	2.5s	24MHz	10kHz	3kHz
	Continuous	1.6	24MHz	10kHz	3kHz
NADC	Uplink	10s (Full rate) 20sec (Half rate)	4MHz	10kHz	3kHz
	Downlink	270ms	4MHz	10kHz	3kHz

For continuous signals, set Sweep Time to AUTO.

**CAUTION !**

*The above setup does not comply with MKK technical standards because the spurious is defined using 100 kHz (the PDC system) and 300 kHz (the PHS system) for the RBW.*

*The above settings are used to detect CW signals (without modulation) within the measurement bandwidth.*

(This page has been intentionally left blank.)

● Power measurement function

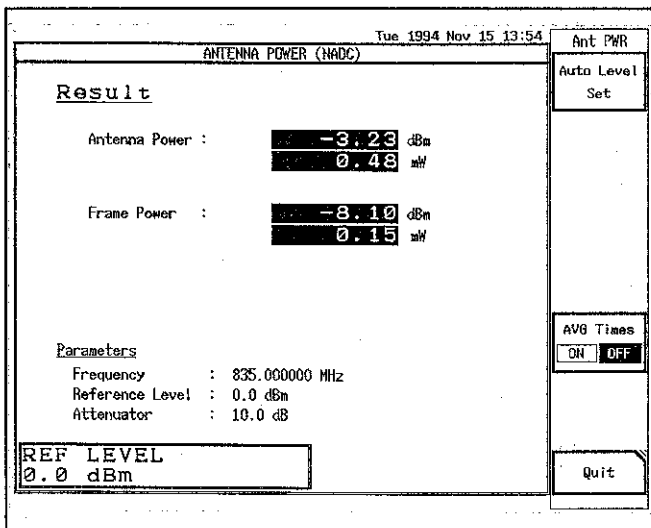
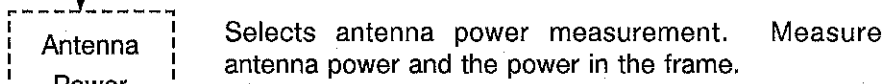
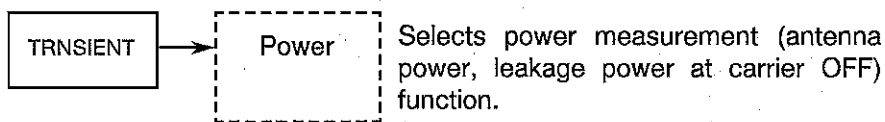
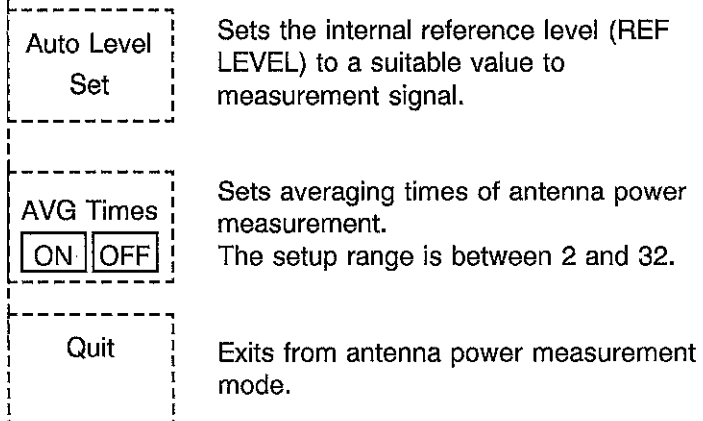

Figure 7-30 Antenna power measurement screen



Carrier  
OFF Power

Selects Carrier OFF leakage power measurement.

**CAUTION!**  
 The measurement range of Carrier OFF leakage power is under -30dBm.

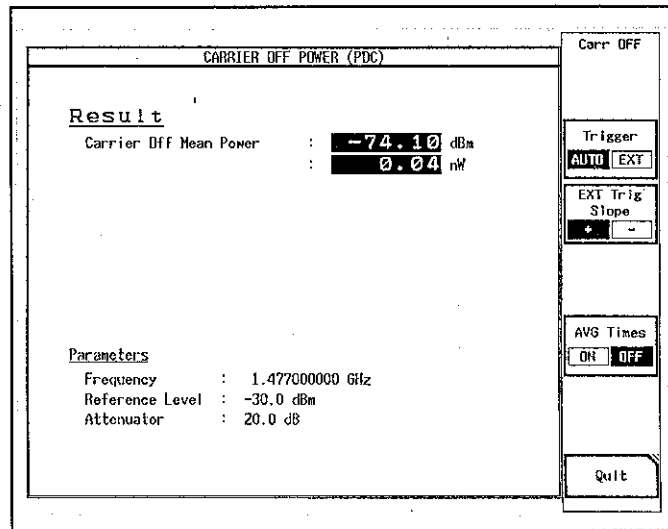

Figure 7-31 Leakage power measurement screen at Carrier OFF

Trigger

Selects to measure in OFF section (AUTO) detected in measurement timing or to measure in OFF section (EXT) specified by external trigger point. (Set EXT when external wide band trigger is used at PHS.)

EXT Trig Slope

Selects external trigger slope.

AVG Times

Sets averaging times of leakage power measurement at carrier OFF. The range is between 2 and 32.

Quit

Exits from Carrier OFF leakage power measurement mode.



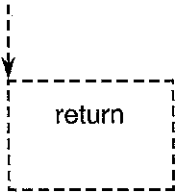

Returns to the preceding menu.

● Modulation accuracy measurement function

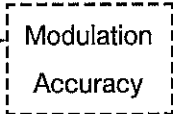

Selects modulation accuracy measurement function. Measures 6 item parameters of carrier frequency error, phase error, vector error, etc. and display.

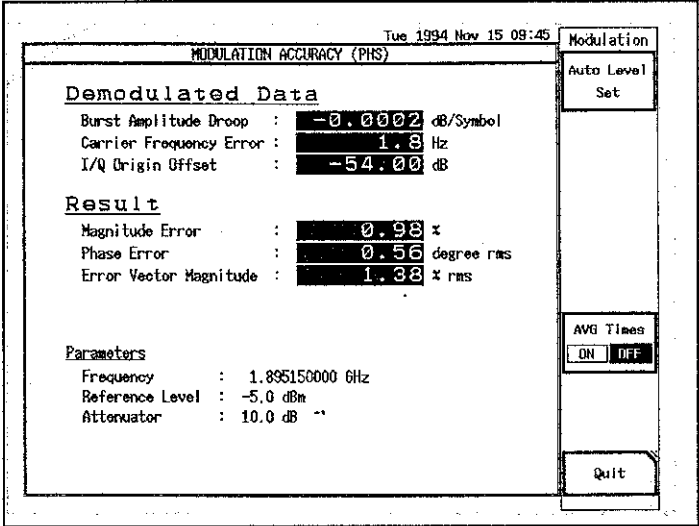
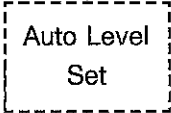
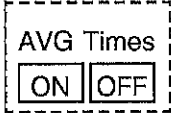

Figure 7-32 Modulation accuracy measurement screen



Sets the internal reference level (REF LEVEL) to a suitable value to measurement signal.



Sets the averaging times of modulation accuracy measurement. The setup range is between 2 and 32.

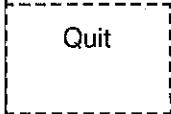

Exits from the modulation accuracy measurement mode.

● Transmission velocity measurement

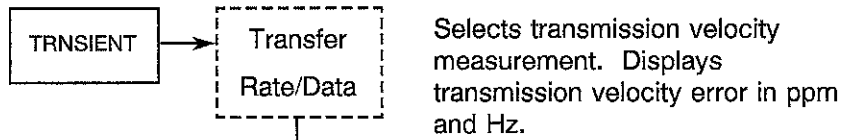

Selects transmission velocity measurement. Displays transmission velocity error in ppm and Hz.

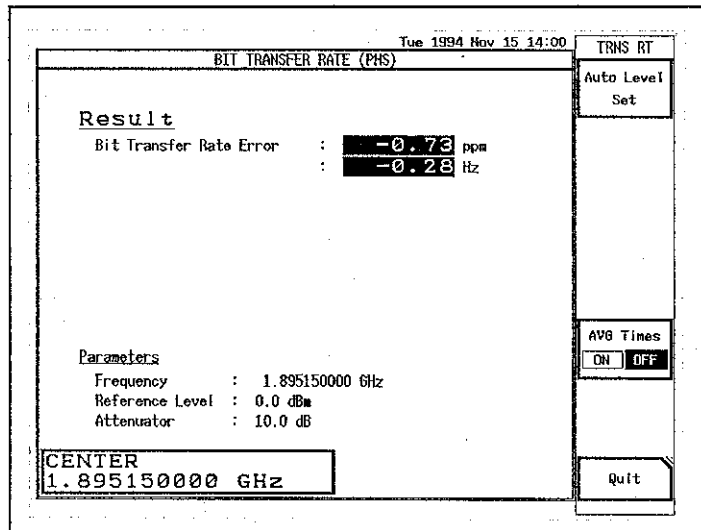
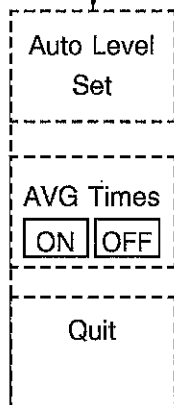

Figure 7-33 Transmission velocity measurement screen



Sets the internal reference level (REF LEVEL) to a suitable value to measurement signal.

Sets the averaging times of transmission velocity measurement. The setup range is between 2 and 32.

Exits from the transmission velocity measurement mode.

## Explanation of communication system setup

By pressing **TRNSIENT** **STD** in order, communication system setup menu is displayed.

Sets communication type and link of the signal under measurement.

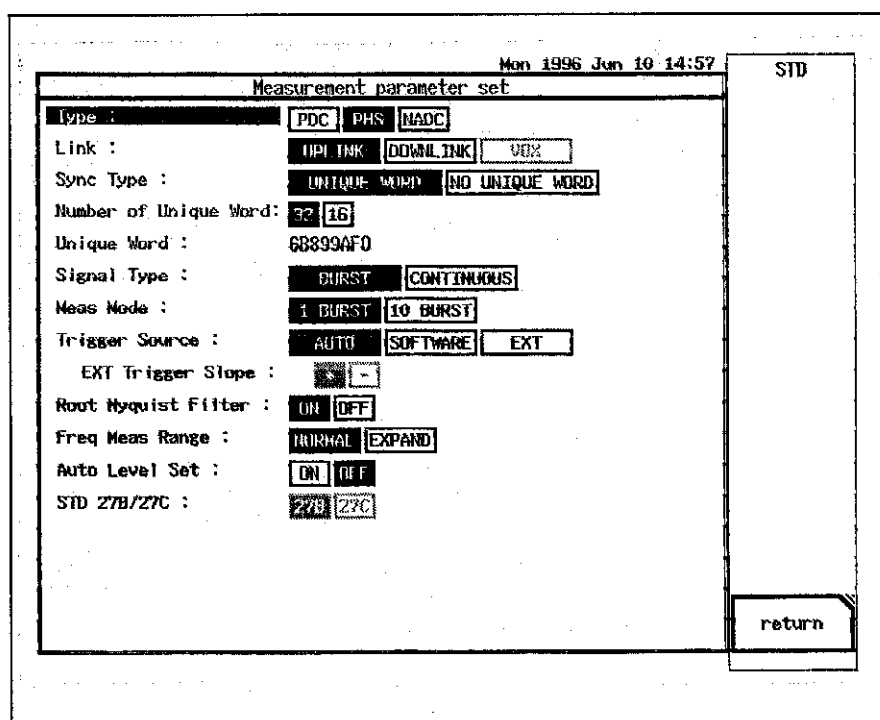

Figure 7-34 Communication type setup menu

In the type of setup items, set a communication type out of PHS / PDC / NADC.

Depending on this setup, the following setup items is changed.

### **CAUTION !**

*If only the type items are set when it's measured in CW mode, the setup conditions can be selected conformed to the corresponding communication type.*

● When PHS is set,

Type : PHS

Link Direction : Set the direction of communication channel.  
 UPLINK ; Uplink channel.  
 DOWNLINK ; Downlink channel.

SYNC Type : Set for modulation accuracy and symbol rate measurement.  
 UNIQUE WORD ; Get synchronous by using Unique Word.  
 NO UNIQUE WORD ; Measure without using Unique Word.

Number of Unique Word : Set bit number of Unique Word.  
 Set only when UNIQUE WORD is selected at SYNC Type.  
 32 ; Set to 32 bit.  
 16 ; Set to 16 bit.

Unique Word : Displays Unique Words which are fixed by the setup combination of Link Direction and Number of Unique Word.

Link Direction	Number of Unique Word	Unique Word
UPLINK	16	0X E149
	32	0X 6B899AF0
DOWNLINK	16	0X 3D4C
	32	0X 5DEF2993

Signal Type : Continuous : Set for continuous wave in test.  
 Usually the signal of PHS is burst wave.  
 Burst : Usually, set Burst.

● When PDC/NADC is set,

- Type : PDC/NADC
- Link Direction : Set the direction of communication channel.  
UPLINK ; Uplink channel.  
DOWNLINK ; Downlink channel.  
VOX ; VOX control (only for PDC)
- SYNC Type : Set for modulation accuracy and symbol rate measurement.  
SYNC WORD ; Get synchronous by using Unique Word.  
NO SYNC WORD ; Measure without using Unique Word.
- Codec : Set signal rate.  
FULL RATE ; Set to full rate.  
HALF RATE ; Set to half rate.
- SYNC Word : Set only when SYNC WORD is selected for SYNC Type.  
PDC S1 to S3 and S7 to S9 can be set at FULL RATE, and at HALF RATE, S1 to S12 can be set.  
NADC Sync 1 to Sync 6 can be set.
- STD 27B/27C: It is effective only when PDC is set.  
Select the standard template for Wave Form Trigger.  
27B ; A template pursuant to RCR STD-27B is set.  
27C ; A template pursuant to RCR STD-27C is set.

● When PHS/PDC/NADC is set,

- MEAS Mode : 1 Burst ; Evaluate with 1 burst at modulation accuracy measurement.  
10 Burst ; Using 10 symbol of burst rising, evaluate the modulation accuracy with the average of 10 burst.

**CAUTION !**

*The 10 burst cannot be selected for the continuous wave.*

- Trigger Source : AUTO ; Take the data in with internal timing.  
For burst, trigger inside to take the data in.  
EXT ; Take the data in with the external trigger.

Ext Trigger Slope :  
Set only when EXT is selected for Trigger Source.  
+ ; Take the data in when external trigger signal rises.  
- ; Take the data in when external trigger signal falls.

Root Nyquist filter :  
Specify if root nyquist filter is used or not when modulation accuracy is measured.  
ON ; Measures with filter.  
OFF ; Measures without filter.

Freq. Meas Range :  
This is effective for the measurement of the modulation accuracy, Transfer Rate, raise and fall of the burst signal.  
  
Expand ; Measurement frequency range is expanded.  
Normal ; Measurement frequency range is not expanded.

**CAUTION !**

***When you measure the non-modulated signal, use Normal.***

Auto Level Set : Select mode ON/OFF which sets internal reference level to a suitable value to the signal under measurement automatically.  
ON ; Sets reference level to a suitable value automatically. Always checks the level before starting each parameter measurement and sets a suitable value.  
(This function does not work at leakage power measurement at carrier OFF.)  
OFF ; Fixes reference level at the setup value. Set the level manually or with "Auto Level Set" soft key.

# 6. Save Function

## CAUTION !

In the TRANSIENT mode, the List  
Reg/File key is invalid except waveform screens (Wave Form screen/Spectrum screen, etc).

### ■ Save function menu

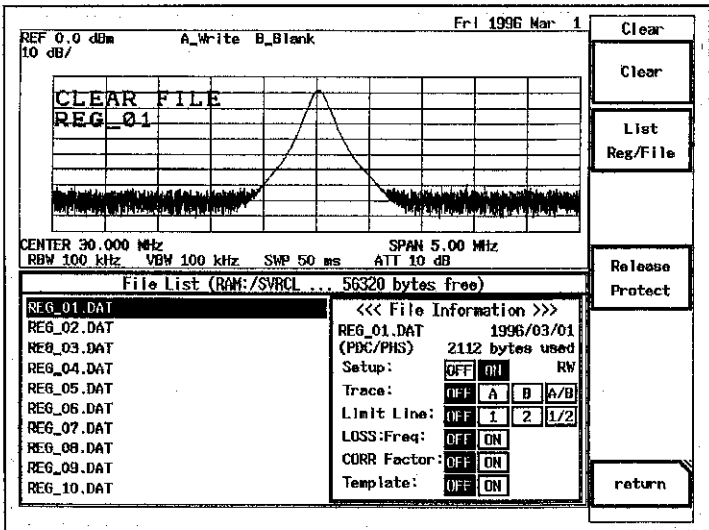
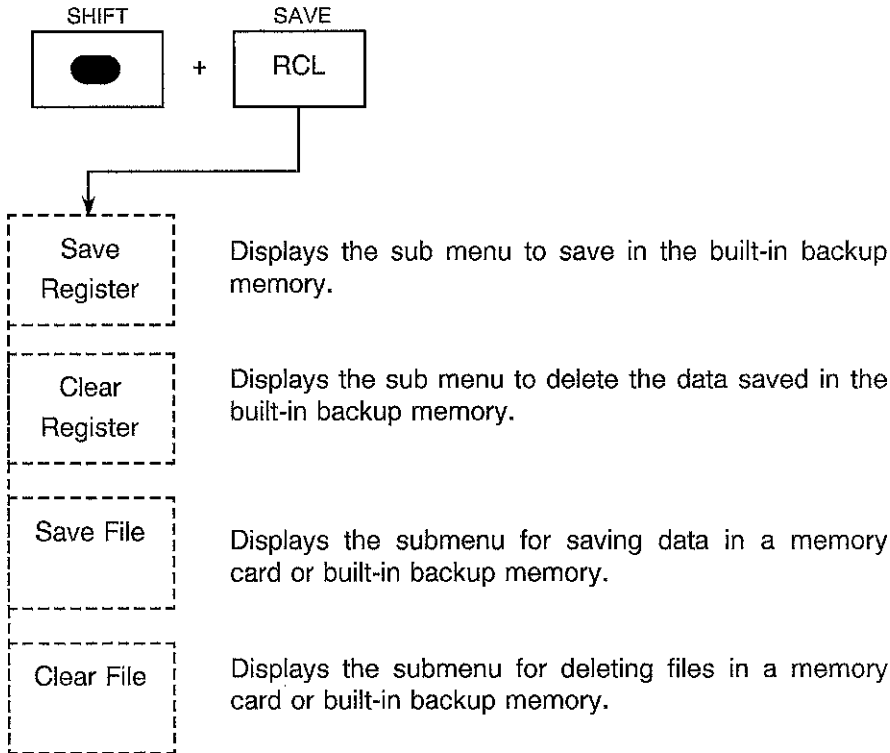

Figure 7-35 Displayed drive list

6. Save Function

List  
Reg/File

Displays the list of the files (or the registers).  
 Displays the file name, title, size, date, write protection and the sort of the saved data.  
 Selects a file (or register) with the step key or with the data knob referring to this list.

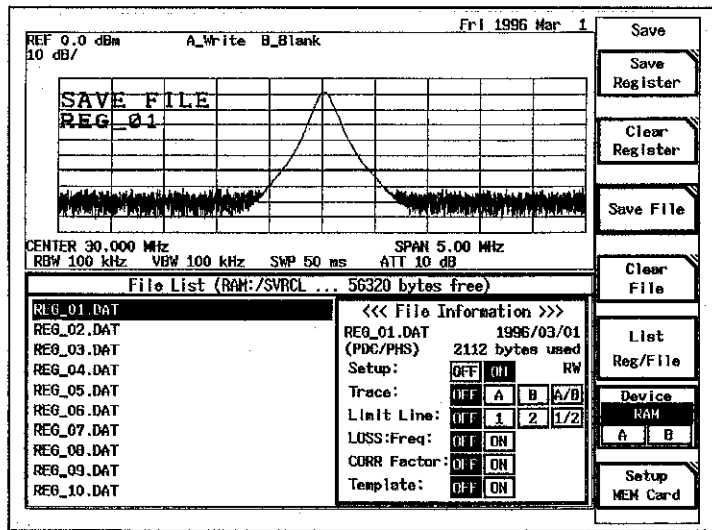

Figure 7-36 Displayed drive list

Device  
RAM  
A B

Selects a drive for saving data (built-in backup memory or memory card (A or B)).

Setup  
MEM Card

Displays the submenu for formatting a memory card or other operations.



● Save Register menu

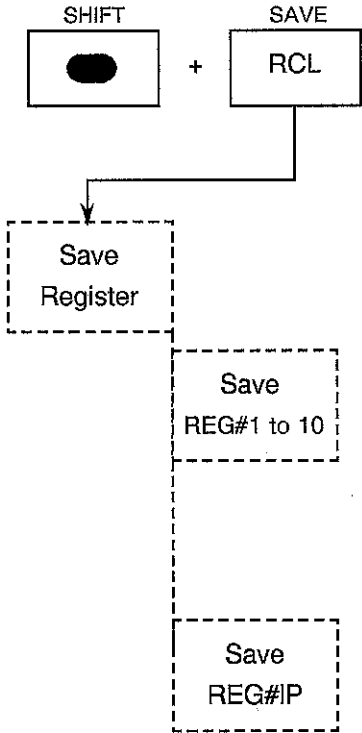

Saves the current set conditions and other data in a register (#1 to #10) allocated in the software menu. The object items of saving are automatically determined according to the condition at saving. (The register is one kind of the files allocated in the built-in backup memory.)

In order to change the content of IP (instrument preset) to the currently set conditions, saves data in IP register.

● Clear Register menu

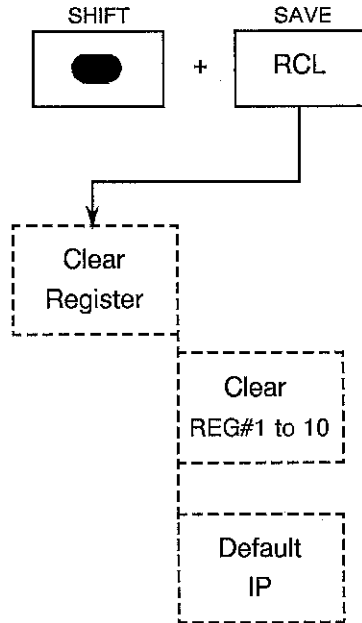

Deletes the contents in the register (#1 to #10) allocated in the software menu.

Initializes the contents of IP (Instrument Preset) to the set condition at shipment.

6. Save Function

● Save File menu

**CAUTION !**

Each software key in Save File is available on the files in the device selected with "Device RAM/A/B" key.

However, in the case that RAM (the built-in backup memory) is selected, the file name cannot be changed by Rename key.

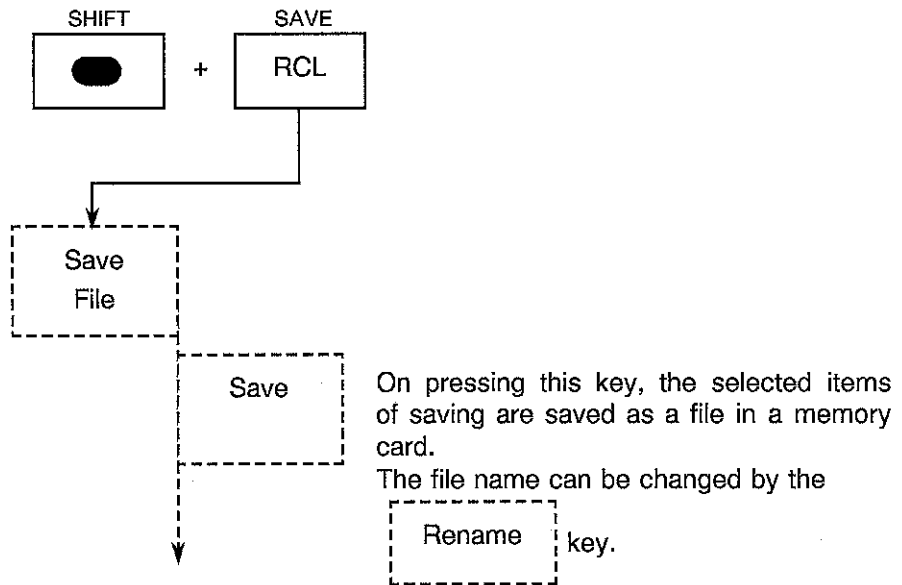

List  
Reg/File

Displays the list of the files (or the registers).  
Displays the file name, title, size, date, write protection and the sort of the saved data.  
Selects a file (or register) with the step key or with the data knob referring to this list.

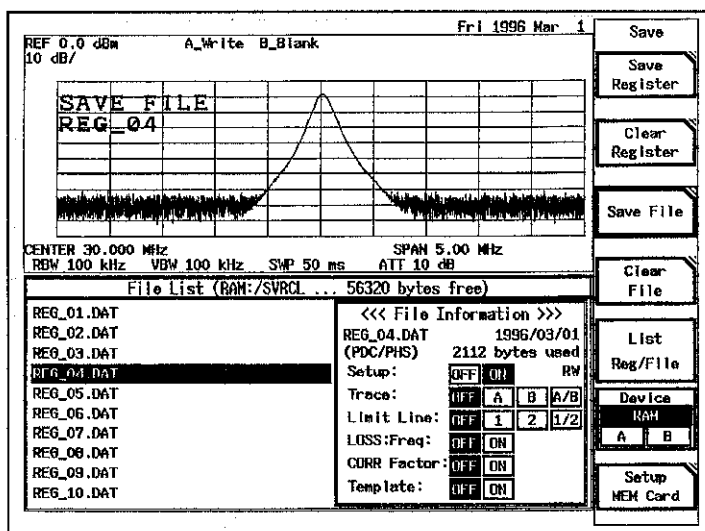

Figure 7-37 Displayed drive list

Enter  
Title

Sets a heading (title) for the saved data so as to be distinguished from other data.

Write  
Protect

Enable/disable write protection for specified file.

Rename

Changes the specified file name.  
Pressing this key, key board dialog box for file name input is displayed in the center of the screen. Select characters with data knob or step key and input the characters by pressing the knob. Up to 8 characters of file name can be input and set with ENTER key.

6. Save Function

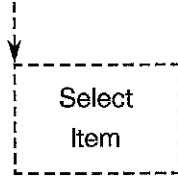

Selects which set conditions and measured data to save with Dialog Box.

This function is used to arbitrarily set conditions, although in general these are automatically selected according to set conditions. To avoid duplication of data, this function is used to save only set conditions. For data, this function is used when data is saved only once and, after that, no longer saved.

The following conditions can be selected:

- Set conditions
- Waveform data A or B (view trace)
- Correction data (normalize trace)
- User defined limit lines 1 and 2 (limit line ON)
- User defined correction data ※1  
(Conv.LOSS vs Freq.ON)
- Correction factor data
- Transient user definition template ※2

※1 : Available for only R3272.

※2 : This is not available for PDC/PHS/NADC measurement.  
(Option is necessary such as GSM measurement.)

● Clear File menu

**CAUTION !**

Each software key in Clear File is available on the files in the device selected with "Device RAM/A/B" key. However, in the case that RAM (the built-in backup memory) is selected, the operation by the "Clear" key is not deleting the files but deleting the data in the files.

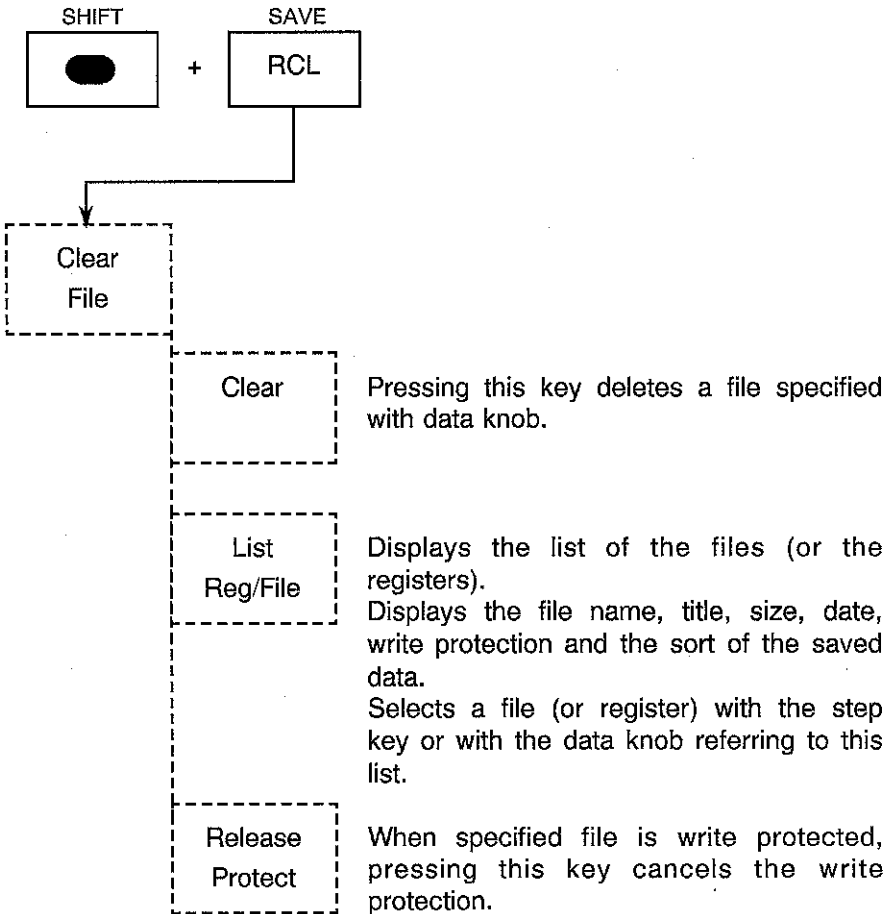

6. Save Function

● Select Item menu

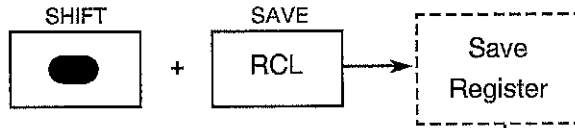

Select Item

On pressing this key, the following dialog box is displayed and the items of saving can be selected. Each item is determined by pressing the data knob after selecting ON and OFF by turning the data knob. And each set items are changed with the step key.

Setup Save Item				
Data Format :	<input type="button" value="BIN"/>			
Setup :	<input type="button" value="OFF"/>	<input type="button" value="ON"/>		
Trace :	<input type="button" value="OFF"/>	<input type="button" value="A"/>	<input type="button" value="B"/>	<input type="button" value="A/B"/>
Limit Line :	<input type="button" value="OFF"/>	<input type="button" value="1"/>	<input type="button" value="2"/>	<input type="button" value="1/2"/>
LOSS:Freq :	<input type="button" value="OFF"/>	<input type="button" value="ON"/>		
CORR Factor :	<input type="button" value="OFF"/>	<input type="button" value="ON"/>		
Template :	<input type="button" value="OFF"/>	<input type="button" value="ON"/>		

Default

In general, selects which item to save according to set conditions. The select conditions are as follows:

- Set conditions : ON
- Waveform data A and B : view trace side
- User defined limit lines 1 and 2 : limit line ON
- Conv.LOSS vs Freq.ON user defined correction data : LOSS vs Freq.ON ※1
- Correction factor data : Correction ON
- Transient user definition template : OFF ※2

※1 : Available for only R3272.  
 ※2 : This is not available for PDC/PHS/NADC measurement.  
 ( Option is necessary such as GSM measurement.)

return

Returns to the preceding menu.

# 7. Recall Function

## CAUTION !

In the TRANSIENT mode, the  
Form screen/Spectrum screen, etc).

List  
Reg/File

key is invalid except waveform screens (Wave

### ■ Recall function menu

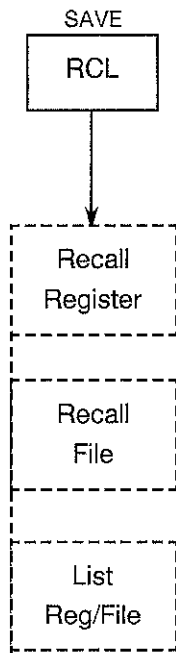

Displays the sub menu to recall in the built-in back up memory.

Displays the sub menu for recalling data from a file in a memory card.

Displays the list of the files (or the registers).  
Displays the file name, title, size, date, write protection and the sort of the saved data.  
Selects a file (or register) with the step key or with the data knob referring to this list.

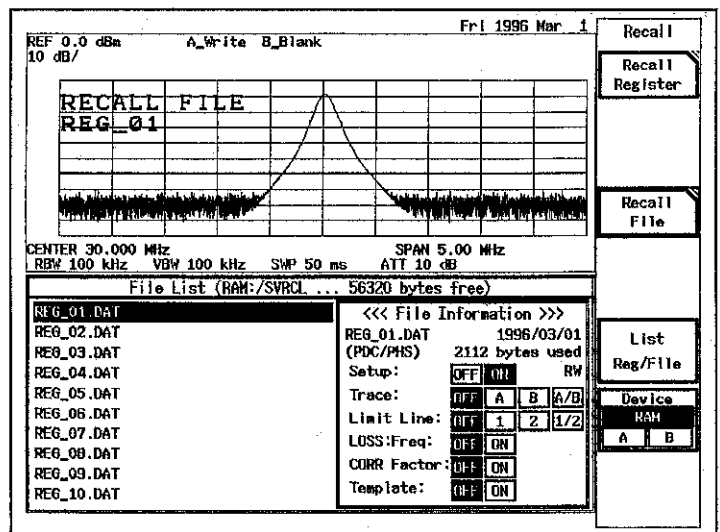
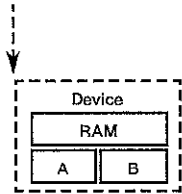

Figure 7-38 Displayed drive list

7. Recall Function



Selects the embedded backup memory or the memory card (A/B) as a drive to save.

● Recall Register menu

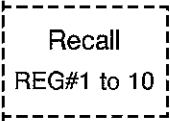
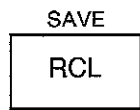

Recalls the current set conditions and other data from the register (#1 to #10) allocated in the software menu.

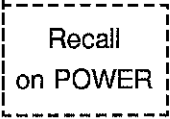

Recalls the setting condition made just after switching on the instrument.



● Recall File menu

**CAUTION !**

*Recall File is available on the files in the device selected with "Device RAM/A/B" key.*

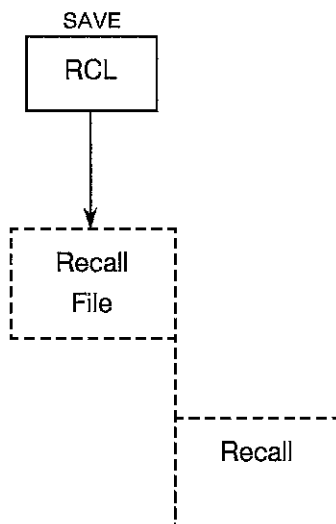

Pressing this key after selecting a file from the file list with data knob recalls set conditions and measured data from the specified file.

## 8. Calibration Function

### ■ Recall function menu

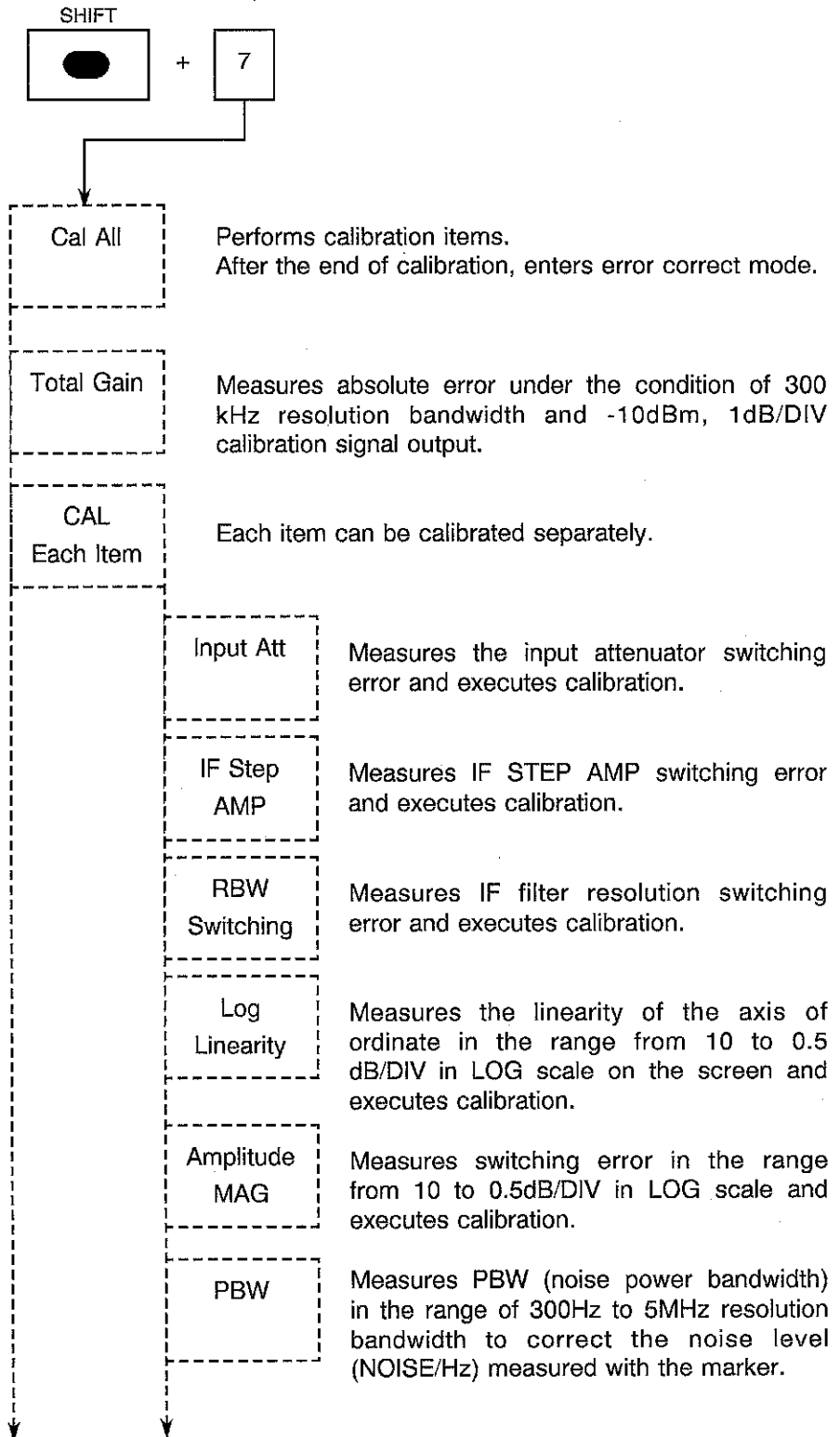

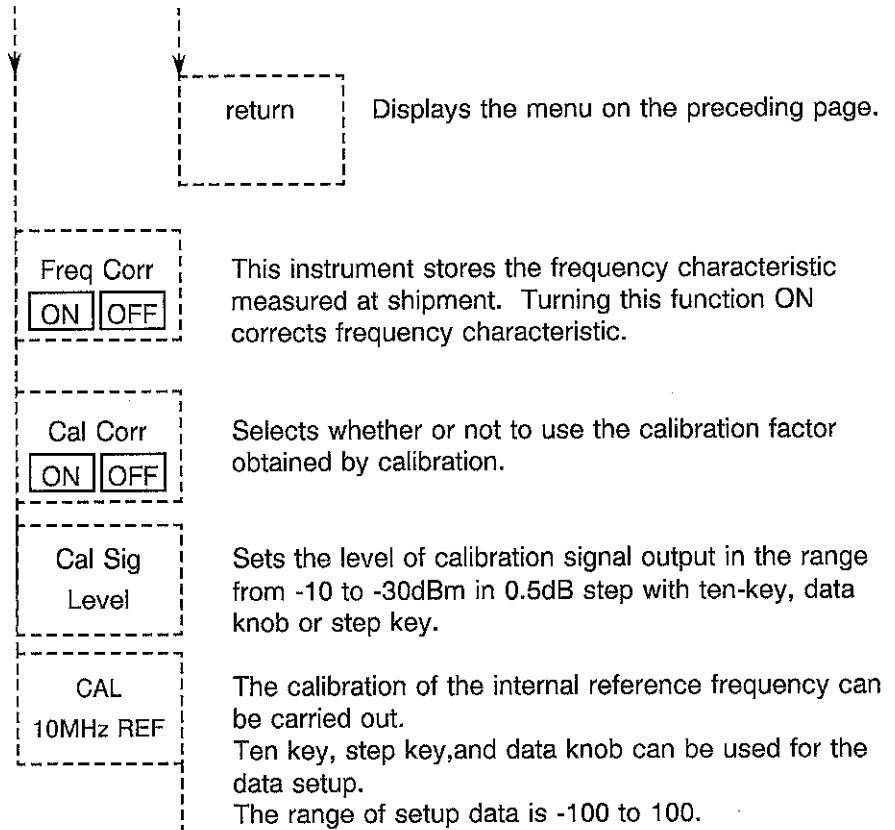

**REFERENCE →**

***How to calibrate the internal frequency reference source***

***To calibrate the internal frequency reference source, connect the frequency comparing device with the analyzer and the external 10 MHz reference signal source as follows.***

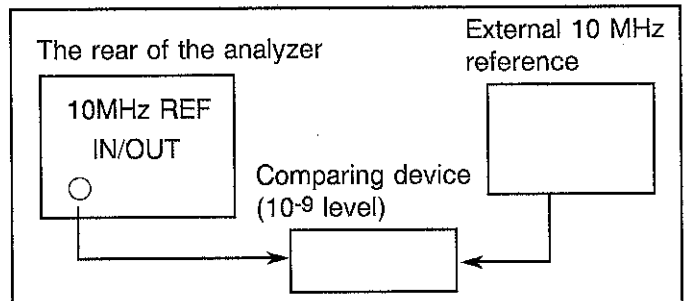

Press

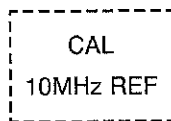

***and change the data from -100 to 100 until the internal reference signal become equal to the external 10 MHz reference signal.***

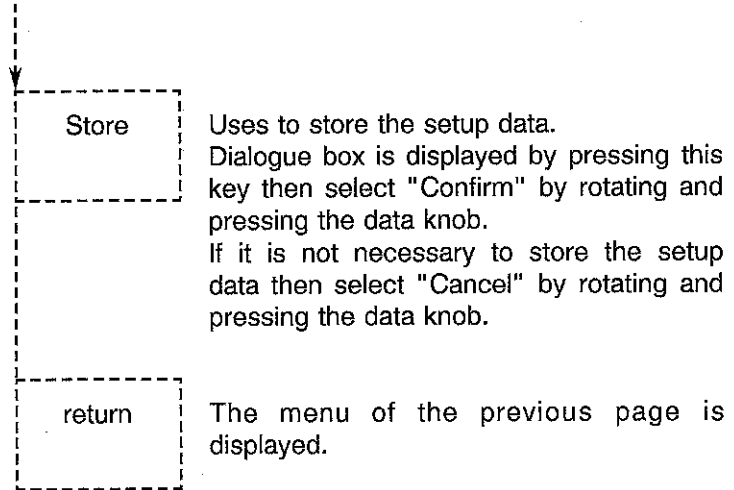

**CAUTION !**

*Sometimes there is a switching noise in the equipment on executing the calibration; it is caused by the switching of the internal attenuator.*

*Use the attached BNC cable(150mm) as the input cable.*

# 9. System Functions

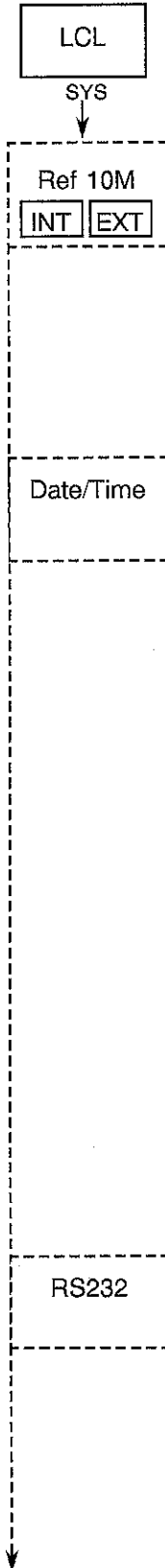

Selects whether internal (INT) or external (EXT) reference frequency (10 MHz) to use. When EXT is selected, external signal input through the REF IN/OUT terminal on the rear panel is used. (Frequency error and level of input signal must be  $5 \times 10^{-6}$  or less and in the range from -5 to +5 dBm, respectively.) When external reference frequency is selected, the characters of "EXT" is displayed at the left side on the screen.

Sets date and time. Select an item with arrow key and change data with ten-key or data knob. Each data is set by pressing the knob or ENTER key after changing the data. The date and the time become available immediately after the changing.

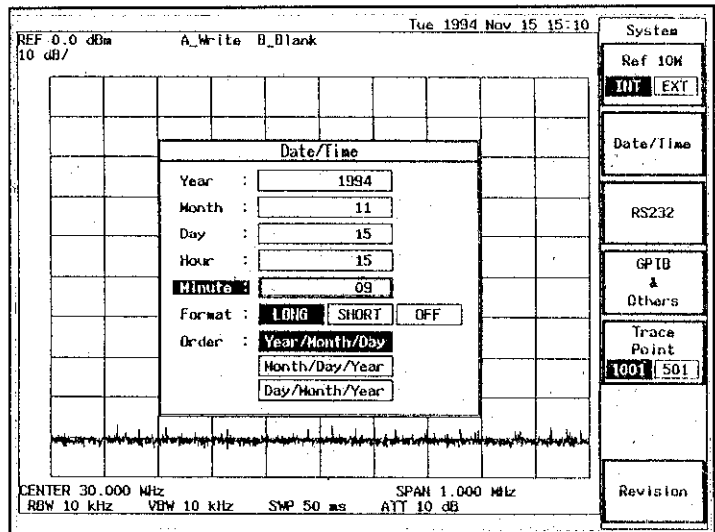
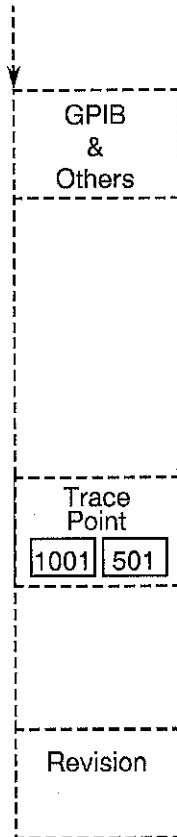

Figure 7-39 Setting the date and time

Sets conditions for RS-232.



Sets address for GPIB. Addresses from 0 to 30 are available. Moreover, the target device can be set at the time of pressing COPY key.

**CAUTION !**

*If the power is turned off after the setting is changed but the dialog Box is being displayed, the setting is ignored.*

Selects the number of points for trace data. Initial value is 1001.

**Note:** *Sometimes the current trace data is displayed temporarily by the number of its point when the number point is switched.*

Displays the software revision of this instrument.

## 10. Window Function

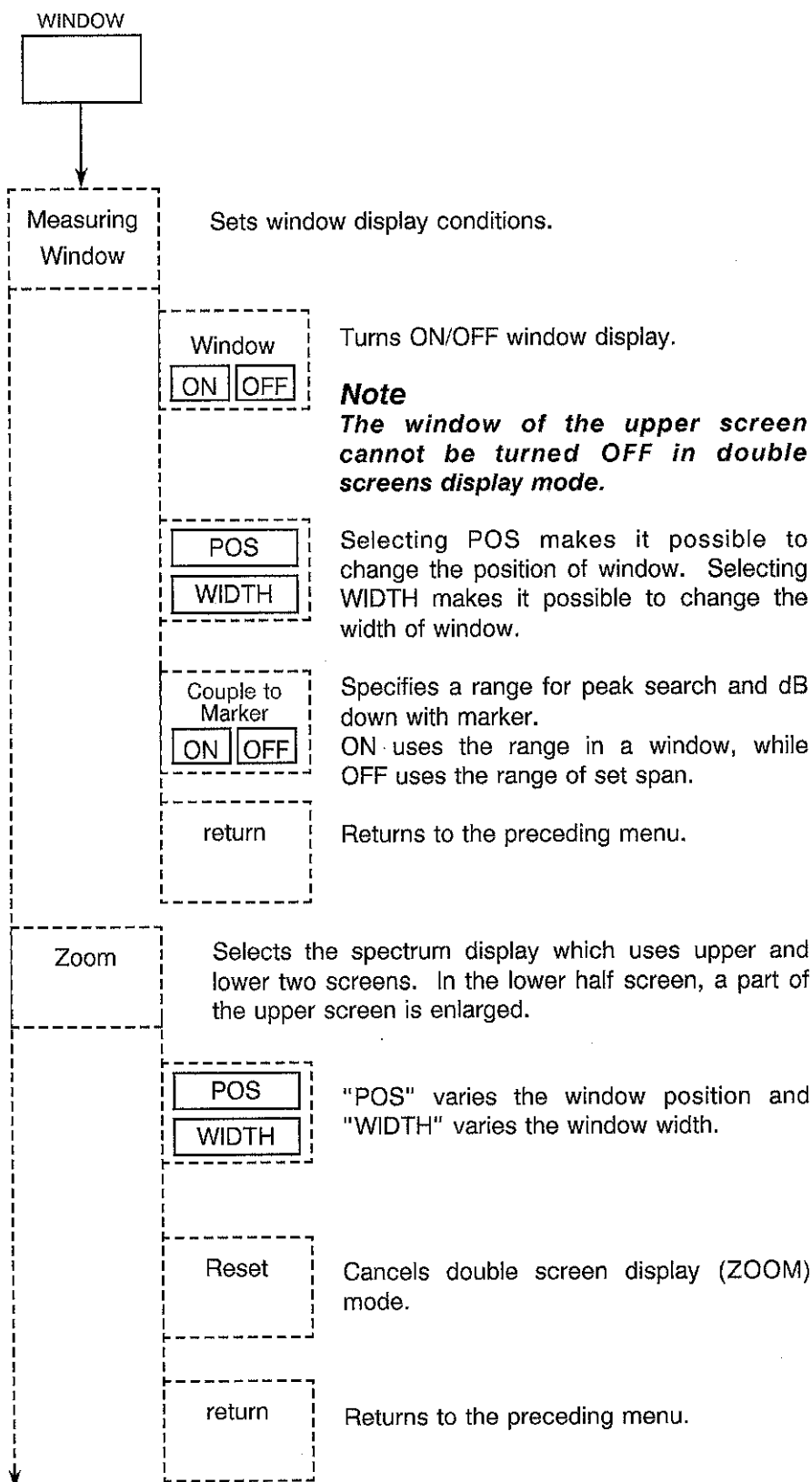

10. Window Function

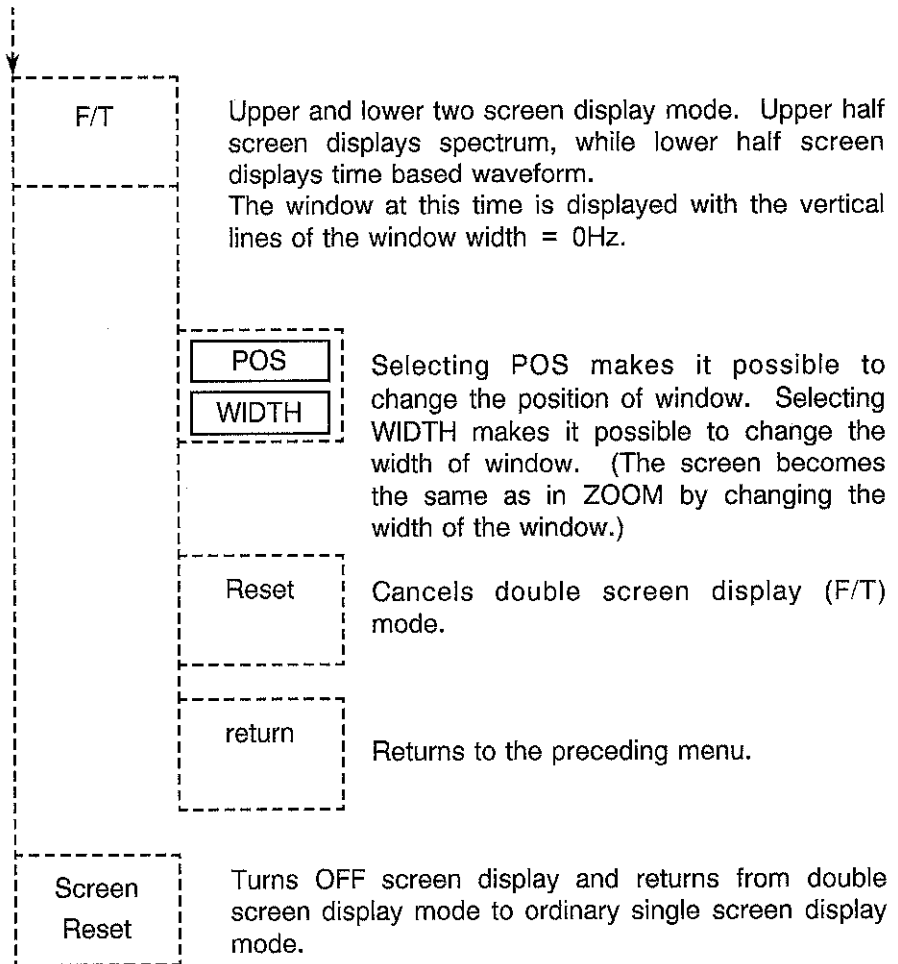

Executes the selection of the active screen in double screen display mode.

**SCREEN**

On pressing **A**, the upper screen becomes active.

On pressing **B**, the lower screen becomes active.

**Note**

*A frame is displayed around the scale on the active screen.*



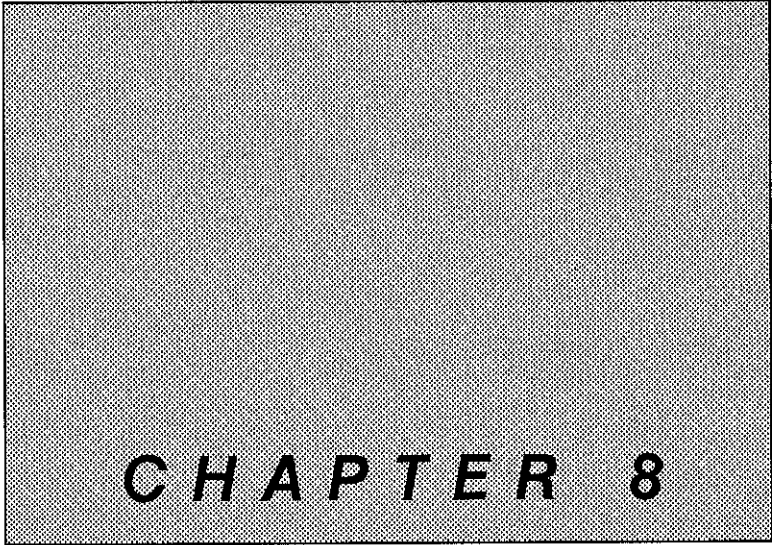

## REMOTE CONTROL INTERFACE

This chapter explains external control via GPIB or RS-232 interface and GPIB command codes.

---

### CONTENTS

---

1. Introduction .....	8-2
2. GPIB BUS Functions .....	8-5
3. Command Syntax .....	8-10
4. Status Bytes .....	8-13
5. List of GPIB Command Codes .....	8-22
6. Sample programs .....	8-43
7. RS-232 Remote Control Function .....	8-70
8. Batch Measurement Command for the TRANSIENT mode of the Transmission System .....	8-80

---

# 1. Introduction

The spectrum analyzer is equipped with a GPIB (General-Purpose Interface Bus) as standard, which complies with IEEE standards 488.1-1978 and can be remotely controlled by means of an external controller. The analyzer also has a built-in control function, enabling easy configuration of small GPIB systems. (Option)

## ■ GPIB

The GPIB is a high-performance interface bus used to connect the measuring instruments to the computer.

The operations of the GPIB are defined by IEEE standard 488.1-1978. Since the GPIB has a bus-configured interface, it can specify a device by assigning a specific address to each device. Up to 15 devices can be connected in parallel to a single bus. GPIB devices have one or more of the following functions:

### ● Talker

The talker is a device which is specified to send data to the bus. Only one active talker can exist on the GPIB bus.

### ● Listener

The listener is a device which is specified to receive data from the bus. Multiple active listeners can exist on the GPIB bus.

### ● Controller

The controller is a device which specifies the talker and listener. Only one active controller can operate on the GPIB bus. Controllers which control IFC and REN messages are called "system controllers".

The GPIB bus can have only one system controller on it. If there are multiple controllers on the bus, the system controller becomes the active controller, while other devices which have a control function operate as addressable devices when the system is started up.

The TCT (Take Control) interface message is used to set a controller other than the system controller as the active controller. After setting, the system controller will become the non-active controller.

The controller controls the entire system by sending interface messages or device messages to each measuring instrument. The functions of the messages are:

- Interface message: Control of the GPIB bus
- Device message: Control of the measuring instrument

## ■ GPIB Setup

### ● Connecting GPIB

The following shows the standard GPIB connector. Secure the GPIB connector with the two screws to prevent it from coming loose during use.

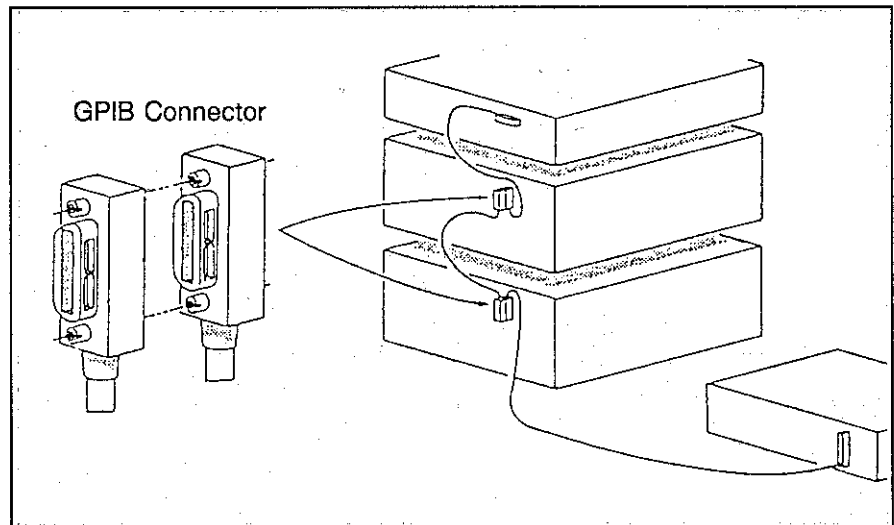

The following precautions should be observed when using the GPIB interface:

- The total GPIB cable length in a single bus system should not exceed  $n \times 2$  meters, where  $n$  = the number of devices to be connected, including the GPIB controller. In no case should the cable length exceed 20 meters.
- Up to 15 devices can be connected to a single bus system.
- There are no restrictions concerning the method of connection between cables. However, no more than three GPIB connectors should be connected to a single device, since the use of excessive force could damage the connector mounting.

For example, the total cable length in a system with 5 devices should be 10 meters or less ( $2 \text{ meters} \times 5 \text{ devices} = 10 \text{ meters}$ ). The total cable length can be distributed freely within the range of the maximum allowed cable length. However, if more than 10 devices are to be connected, some of them should be connected using cables of less than 2 meters so that the total cable length does not exceed 20 meters.

● **Setting of GPIB address**

- 1 Press 

LCL
SYS

 and 

GPIB
&
Others

 keys.
- 2 With ten-key, input GPIB address for this instrument.
- 3 Press 

Hz
----

 key to enter.

## 2. GPIB BUS Functions

### ■ GPIB Interface Functions

Code	Description
SH1	Source handshake function
AH1	Acceptor handshake function
T6	Basic talker function, serial polling function, listener-specified talker cancel function
TE0	Without extended talker function
L4	Basic listener function, talker-specified listener cancel function
LE0	Without extended listener function
SR1	Service request function
RL1	Remote function, local function, local lockout function
PP0	Without parallel polling function
DC1	Device clear function
DT0	Without device trigger function
C1	System controller function
C2	IFC transmission, controller in charge function
C3	REN transmission function
C4	SRQ response function
C12	Transmission of interface messages, control transfer function
E1	Using open-collector bus driver

**Note**

*C1, C2, C3, C4 and C12 function only when the options are packaged.*

*C0 (no system controller function) is in the standard instrument without controller option.*

## ■ Controller Functions

R3463/3465 has a system controller mode and an addressable mode. The features of each mode are as follows:

	System Controller Mode (option 15)	Addressable Mode
At startup	Active controller	Non-active controller
IFC	Controllable	Not controllable
REN	Controllable	Not controllable

To be active in the addressable mode, R3463/3465 must have received the TCT interface message.

Only one system controller is allowed on the GPIB bus. When a system connected through the GPIB bus is started up, the system controller becomes the active controller. Only one active controller at a time is allowed on the GPIB bus. The controller controls the devices on the bus by sending interface messages and receiving service requests (SQR). Note that the IFC and REN interface messages are sent by the system controller only.

Interface messages are used to send indications of talker and listener, serial poll, device clear, trigger, local, and the other information to the measuring instrument. Service requests are used to receive interruptions from the instrument.

The active controller can transfer control to any non-active controller. After specifying the talker as the device to which control is to be transferred, the active controller sends a TCT interface message to transfer control to the talker. This operation is called "pass control".

When the system controller sends an IFC interface message, control is returned from the active controller to the system controller.

## ■ Responses to Interface Messages

The responses of the instrument to interface messages are defined by IEEE standards 488.1-1978 and are described in this section. For information on how to send interface messages to the instrument, refer to the instruction manual of the controller to be used.

### ● Interface Clear (IFC)

The IFC message is transmitted directly to the instrument through a signal line. The message allows the instrument to stop the operation of the GPIB bus. Although all input/output operation is stopped, the input/output buffer is not cleared. Note that the DCL is used to clear the buffer. If the instrument is specified as an active controller at that time, control of the GPIB bus will be removed from the instrument and transferred to the system controller.

### ● Remote Enable (REN)

The REN message is transmitted directly to the instrument through a signal line. If the instrument is specified as a listener when the message is true, the instrument is in the remote mode. The instrument remains in the remote mode until the GTL message is received, or the REN becomes false, or the LOCAL key is pressed. When the instrument is in the local mode, it ignores all the received data. When the instrument is in the remote mode, it ignores all key inputting other than LOCAL key inputting. When the instrument is in the LOCAL LOCKOUT mode (LLO; see **Page 8-8**), it ignores all key inputting.

### ● Serial Polling Enable (SPE)

When the instrument receives a message from external devices, it is in the serial polling mode. If the instrument is specified as a talker in this mode, it sends status bytes instead of normal messages. The instrument remains in the serial polling mode until the SPD (Serial Polling Disable) message or the IFC message is received.

When the instrument sends an SRQ (Service Request) message to the controller, bit 6 (RQS bit) of the response data is set to 1 (true). When the instrument has finished sending this message, the RQS bit reverts to 0 (false). The SRQ (Service Request) message is sent directly through a signal line.

### ● Device Clear (DCL)

When the instrument receives the DCL message, it performs the following:

- Clearing of the input and output buffers
- Resetting of syntax analysis, execution control and response data generation
- Cancellation of all commands that prevent the remote command from being executed next
- Cancellation of commands that are paused to wait for other parameters

## 2. GPIB BUS Functions

It does not perform the following:

- Changing of data set or stored in the instrument
- Interruption of the front panel operation
- Modification or interruption of instrument operations being executed
- Changing of status bytes other than MAV. (MAV becomes 0 when the output buffer is cleared.)

### ● Selected Device Clear (SDC)

The SDC message operates in the same manner as the DCL message. However, it is executed only when the instrument is as a listener. In other cases, it is ignored.

### ● Go To Local (GTL)

The GTL message places the instrument in the local mode. In the local mode, all the operations on the front panel are available.

### ● Local Lockout (LLO)

The LLO message places the instrument in the local lockout mode. If the instrument is set to the remote mode in this mode, all the operations on the front panel will be inhibited. (Note that in the normal remote mode, front panel operations can be performed using the LOCAL key.)

The following three methods can be used to set the instrument to the local mode from the local lockout mode:

- Sending a GTL message to the instrument
- Setting the REN message to false (In this case, the local lockout mode will be canceled.)
- Switching on the instrument power again

### ● Take Control (TCT)

If the instrument receives the TCT message when it is specified as a talker, it becomes the active controller through "pass control". On receiving the IFC message, the instrument returns to the addressable mode.



## ■ Message Exchange Protocol

The instrument receives program messages from controllers or other devices through the GPIB bus and generates response data. The program messages include commands, queries (commands used to query response data) and data. The procedure used to exchange these commands, queries and data is explained in this section.

### ● GPIB Buffers

The instrument is equipped with the following three buffers:

#### ○ Input buffer

The input buffer is used to store data temporarily for command analysis (It has the length of 1024byte but the input above it is ignored.)

Either of the following two methods can be used to clear the input buffer:

- Switching on the instrument power
- Execution of the DCL or the SDC

#### ○ Output buffer

The output buffer is used to store data which are to be read from the controller (1024 bytes).

Either of the following two methods can be used to clear the output buffer:

- Switching on the instrument power
- Execution of the DCL or the SDC

### ● Message exchange

The following are the most important events when another controller or device receives messages from the instrument:

- Response data are generated when a query is received.

#### ○ Purser

The purser receives command messages in the order of reception from the input buffer, analyzes the syntax and determines what the received command is to execute.

#### ○ Generating response data

When the purser executes a query, the instrument generates data in the output buffer in response to it (that is, to output data a query must be sent immediately before the data).

## 3. Command Syntax

### ■ Command Syntax

The command program for R3465 command mode is defined in the following format:

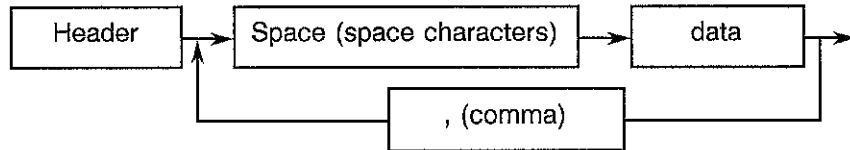

#### ● Header

Two types of header are available: common command header explained below and simple header.

Common command header has an asterisk (\*) at the top of mnemonic.

Simple header is a functionally independent command which has no hierarchical structure.

Attaching "?" in front and in the rear of a header makes a query command.

#### ● Space (space character)

One space or more is required in this field. (A space may be omitted.)

#### ● Data

When the command requires multiple data, the data should be separated with commas. A space may be inserted before or after the each comma. For details of data types, refer to "Data Formats".

For details of data type, see the paragraph for data format (on page 8-11).

#### ● Writing multiple commands

The instrument is possible to write multiple commands by separating them with semicolons.

## ■ Data Formats

The instrument uses the data formats for data input/output shown in this section.

### ● Numeric data

There are three numeric data formats, any of which can be used for numeric data input.

Some commands add the units to the data at data inputting. For information on units, refer to next page.

The following shows the format of the character data.

- Integer type: NR1 format

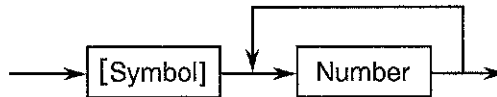

- Fixed-point type: NR2 format

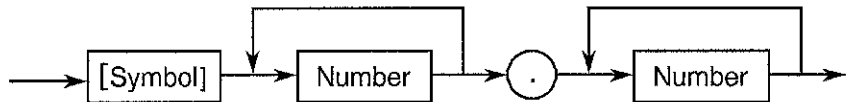

- Floating-point type: NR3 format

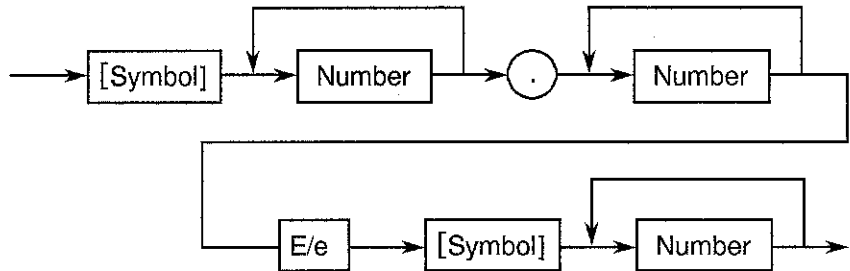

### **Note**

*Symbols at the beginning may be omitted.*

## 3. Command Syntax

● **Units**

The table below lists the units which can be used.

Suffixes	Unit	Commands with which Usable
GZ	$10^9$	Frequency
MZ	$10^6$	Frequency
KZ	$10^3$	Frequency
HZ	$10^0$	Frequency
MV	$10^{-3}$	Voltage
MW	$10^{-3}$	Electric power
DB	$10^0$	dB ratio
MA	$10^{-3}$	Electric current
SC	$10^0$	Second
MS	$10^{-3}$	Second
US	$10^{-6}$	Second

## 4. Status Bytes

The instrument has a hierarchical status register structure in compliance with IEEE standard 488.2-1987, which is used to send various device status information to the controller. This chapter explains the operational models of the status byte and event assignments.

### ■ Status Register

#### ● Status Register Structure

The instrument employs the status register model defined by IEEE standard 488.2-1987 and consists of a condition register, an event register and an enable register.

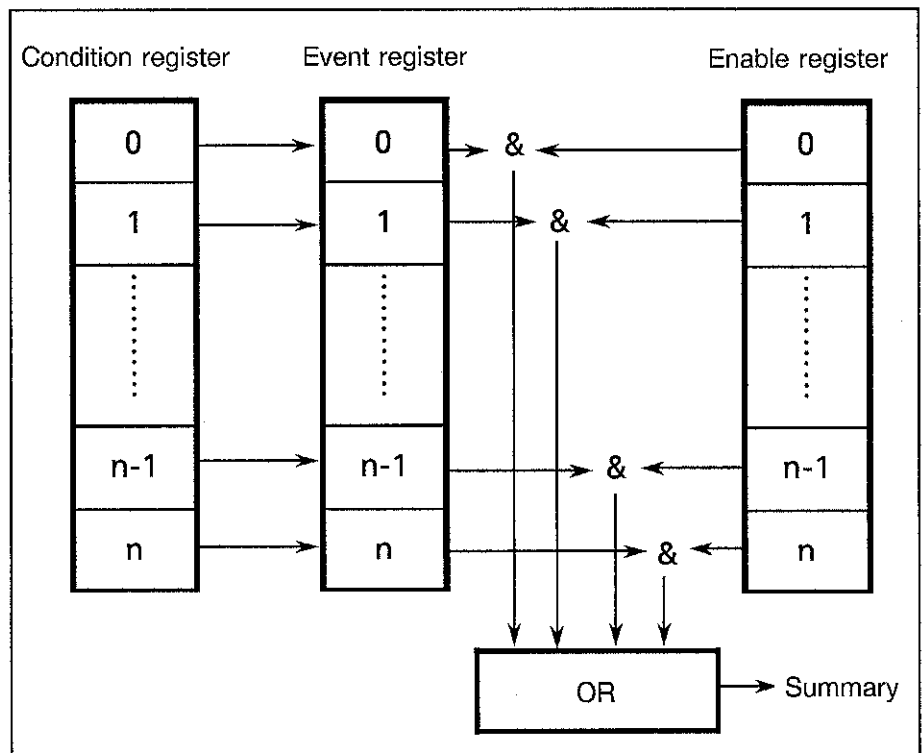

#### ○ Condition register

The condition register continuously monitors the status of devices, that is, retains the latest status of devices. However, this register is retained as the internal information, so, no data can be written or read into this register.

#### ○ Event register

The event register latches and retains the status information from the condition register. (In some cases, it retains status changes.)

Once the register is set, the condition is maintained until a query command reads out the information or the register is reset by means of the \*CLS command. No data can be written into this register.

4. Status Bytes

○ **Enable register**

The enable register specifies which bit in the event register is to be used as the valid status to generate a summary. The enable register is ANDed with the event register. The OR of the result of the AND operation is generated as a summary. The summary is written into the following status registers. Any data can be written into these registers.

● **Status Register Types**

The following three types of status register are used in the instrument:

- (1) Status byte register
- (2) Standard event register
- (3) Standard operation status register

Refer to page 8-15 for further details.

The figure below shows the arrangement of the status registers in the instrument.

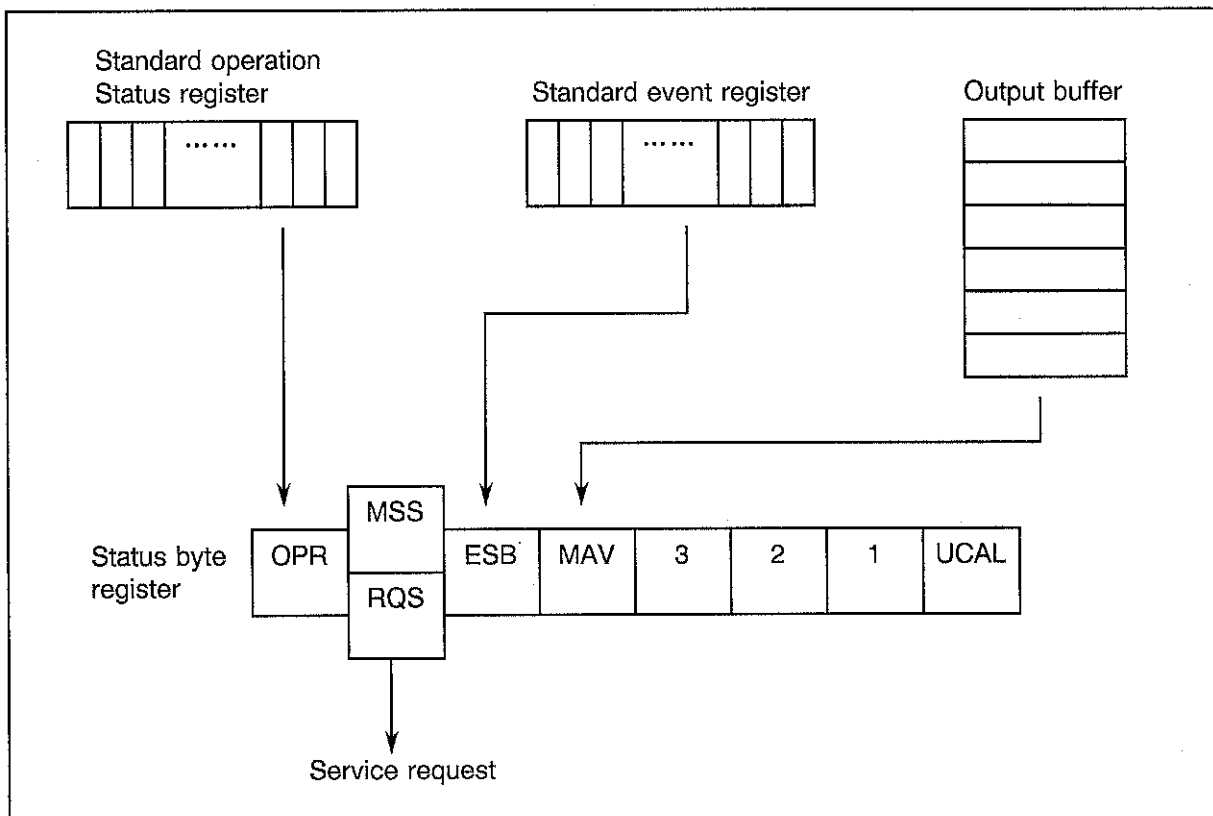

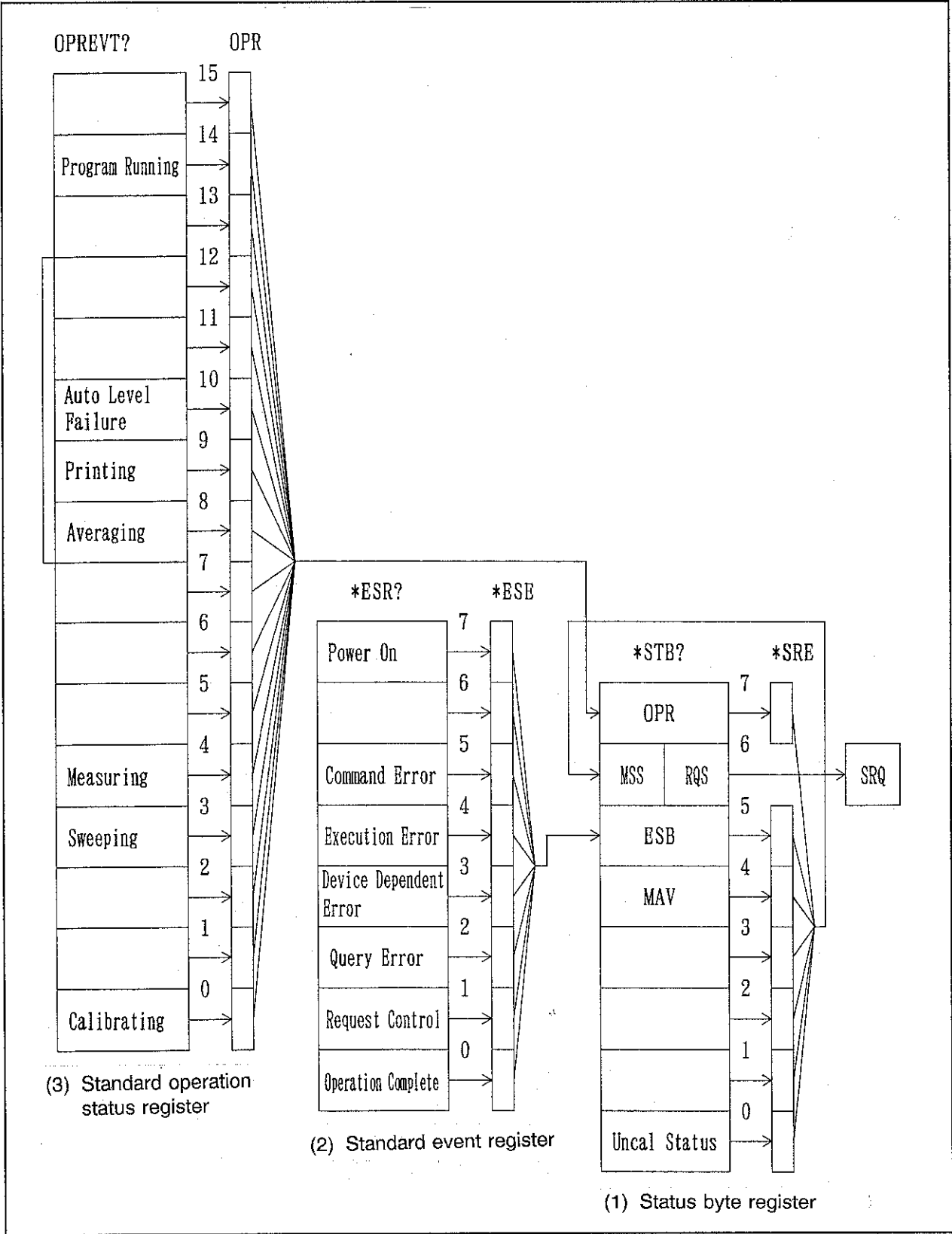

## ■ Event Enable Register

Each event register has the enable register to determine which bit to be available. The enable register sets the corresponding bit in decimal value.

- Set of Service Request Enable Register : \*SRE
- Set of Standard Event Status Enable Register : \*ESE
- Set of Operation Status Enable Register : OPR

Example : Only the Measuring bit in the operation status register is made to be available.

OPR bit of the status byte register is set in 1 when Measuring bit of the operation status register is set in 1.

PRINT @8 ;"OPR16" (The example of the program in N88BASIC.)

OUTPUT 708 ;"OPR16" (The example of the program in the series of HP200 and 300.)

Example : OPR (the summary of Operation Status Register) bit and ESB (the summary of Event Status Register) bit of the status byte register are made to be available.

MSS bit of the status byte register is set in 1 when OPR bit or ESB bit is set in 1.

PRINT @8 ;"\*SRE160" (The example of the program in N88BASIC.)

OUTPUT 708 ;"\*SRE160" (The example of the program in the series of HP200 and 300.)



## ■ Standard Operation Status Register

### ● Event register

The event register for the standard operation status is used to hold the change from 1 to 0 of the corresponding condition register. The table below shows the assignments of the event register for the standard operation status.

bit		Description
15		Always 0
14	Program running	Set to 1 when the built-in BASIC language stops.
13 to 11		Always 0
10	Auto Level Failure	When the setting of Auto Level is failed, 1 is set.
9	Printing	Set to 1 at the end of printing.
8	Averaging	Set to 1 when averaging finishes.
7 to 5		Always 0
4	Measuring	Set to 1 at the end of sequence measurement.
3	Sweeping	Set to 1 when sweeping finishes.
2 to 1		Always 0
0	Calibrating	Set to 1 when calibration data acquisition finishes.

4. Status Bytes

■ Status Byte Register

The status byte register summarizes the information from the status register (see Page 8-13). In addition, a summary of the status byte register is sent to the controller as a service request. Therefore, the register operates slightly differently from the status register. This section explains the status byte register.

The figure below shows the structure of the status byte register.

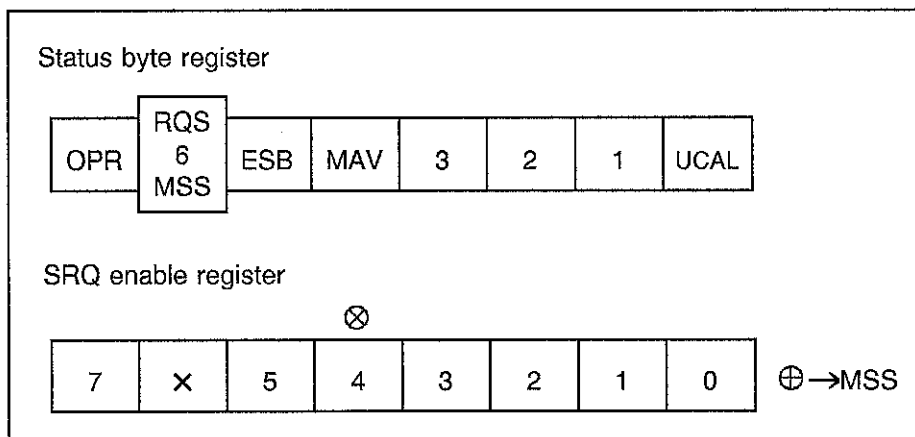

The register has the same functions as the status register explained in Page 8-13, except with regard to the following three points:

- ① The summary of the status byte register is written in bit 6 of the status byte register.
- ② Bit 6 of the enable register is always valid and cannot be changed.
- ③ Bit 6 (MSS) of the status byte register writes the RQS of the service request.

The register responds to the serial polling from the controller. On doing so, bits 0 to 5 and bit 7 of the status byte register and the RQS are read out, then the RQS is reset to 0. The other bits are not cleared until each factor has been reset to 0.

When the \*CLS command and the S2 command are executed, the status byte register, the RQS bit and the MSS bit can be cleared.

The table below explains the meanings of the bits in the status byte register.

bit		Description
7	OPR	<ul style="list-style-type: none"> <li>The OPR bit is a summary of the standard operation status register.</li> </ul>
6	MSS	<ul style="list-style-type: none"> <li>The RQS bit is true when the MSS bit of the status byte register is set to 1. The MSS bit is the summary bit for the entire status data structure.</li> <li>The serial poll cannot read out the MSS bit. (However, the MSS bit is understood to be 1 when the RQS bit is 1.)</li> <li>To read the MSS bit, use the common command *STB?. The *STB? command can read out bits 0 to 5 and bit 7 of the status byte register and the MSS bit. In this case, neither the status byte register nor the MSS bit can be cleared.</li> <li>The MSS bit cannot become 0 until all the unmasked factors in the status register structure have been cleared.</li> </ul>
5	ESB	<ul style="list-style-type: none"> <li>The ESB bit is a summary of the standard event register.</li> </ul>
4	MAV	<ul style="list-style-type: none"> <li>Summary bit for the output buffer.</li> <li>This instrument does not work with it.</li> </ul>
3 to 1		<ul style="list-style-type: none"> <li>Always 0</li> </ul>
0	UCAL	<ul style="list-style-type: none"> <li>Set to 1 when sweep is so fast as to cause signal level error.</li> </ul>

## 4. Status Bytes

## ■ Standard Event Register

The table below shows the assignments of the standard event register.

bit		Description
7	Power on	Set to 1 when this instrument is switched on
6		Always 0
5	Command Error	Set to 1 when the purser finds a syntax error.
4	Execution Error	Set to 1 when the system fails to execute the instruction received as a GPIB command for some reason (such as out-of-range parameter).
3	Device Dependent Error	Set to 1 when errors other than command errors, execution errors, or query errors occur.
2	Query Error	Set to 1 when no data exist or data have been deleted when the controller attempts to read out data from this instrument.
1	Request Control	Set to 1 when this instrument is required to be the active controller.
0	Operation Complete	Not used.

## 5. List of GPIB Command Codes

### Note on Table

- An asterisk (\*) in the Listener Code column indicates that it is a function that needs the input of the numeric data following the code.
- A plus sign (+) in the Output Formats column indicates that multiple data items are output.
- AUTO/MANUAL or ON/OFF in the Output Formats column indicates that the code outputs 1 or 0, respectively.
- "-" means impropriety.
- All frequencies are in Hertz (Hz), and all times are in seconds or fractions of a second. And the levels are output in the setting display unit.

Function	Listener code	Talker request		Remarks
		Code	Output format	
<b>Center frequency</b>	CF *	CF?	Frequency	
CF Step size	CS *	CS?	Frequency	
CF Step AUTO	CA	CA?	AUTO/MANUAL	
Frequency offset size	FO *	FO?	Frequency	
Frequency offset ON	FON *	-	-	
Frequency offset OFF	FOF	-	-	
<b>Frequency span</b>	SP *	SP?	Frequency	
Full span	FS	-	-	
Zero span	ZS	-	-	
<b>Start frequency</b>	FA *	FA?	Frequency	
<b>Stop frequency</b>	FB *	FB?	Frequency	
Pre-selection				
Auto peaking	PPA	-	-	Only R3465
Manual peaking	PPM *	PPM?	Integer	Only R3465
Preselector 1.7G	PRESL STD	-	-	Only R3465
3.0G	PRESL EXTD	-	-	Only R3465

5. List of GPIB Command Codes

(cont'd)

Function	Listener code	Talker request		Remarks
		Code	Output format	
<b>Reference level</b>	RL *	RL?	Level	
X dB/div	DD *	DD?	0: 10 dB/ 1: 5 dB/ 2: 2 dB/ 3: 1 dB/ 4: 0.5 dB/	
LINEAR	-	LN?	0: ×1 1: ×2 2: ×5 3: ×10	
LINEAR ×1	LL1	-	-	
LINEAR ×2	LL2	-	-	
LINEAR ×5	LL5	-	-	
LINEAR ×10	LL10	-	-	
Reference level display unit	-	UNIT?	0: dBm 1: dBmV 2: dB $\mu$ V 3: dB $\mu$ Vemf 4: dBpW 6: V 7: W	
Reference level	-	UN?		
	-	AUNITS?		
	dBm	AUNITS DBM	-	-
		KSA	-	-
		UB	-	-
	dBmV	AUNITS DBMV	-	-
		KSB	-	-
		UM	-	-
	dB $\mu$ V	AUNITS DBUV	-	-
		KSC	-	-
		UU	-	-
	dB $\mu$ Vemf	UE	-	-
	dBpW	UW	-	-
	volts	AUNITS V	-	-
	KSD	-	-	
watts	AUNITS W	-	-	
<b>Level offset</b>	RO *	RO?	Level	
Level offset ON	RON *	-	-	
Level offset OFF	ROF	-	-	

(cont'd)

Function	Listener code	Talker request		Remarks	
		Code	Output format		
<b>Sweep mode</b>	-	SWM?	0 : Normal & full 20 : Single & full 1 : Normal & window 21 : Single & window		
Sweep condition	Window	ON OFF	WDOSWP ON WDOSWP OFF	- -	
	Normal		CONTS SN	- -	
	Single		SNGLS SI	- -	
	Reset & Start		SR	-	
	Take sweep (Single sweep action)		TS	-	
	Gate Position		GTPOS *	GTPOS?	Time data
	Gate Width		GTWID *	GTWID?	Time data
	Gated SWP	ON OFF	GTSWP ON GTSWP OFF	GTSWP?	ON/OFF
	Gate Source				
	IF Signal		GTSRC IF	GTSRC?	0 : IF Signal
	EXT Gate in		GTSRC GT	-	1 : EXT Gate in
	EXT Trigger		GTSRC EXT	-	2 : EXT Trigger
	Gate Source Slope	+ -	GTSLP + GTSLP-	- -	- -
	<b>Trigger mode</b>	-	TM?	0 : FREE RUN 1 : LINE 2 : VIDEO 5 : External	

5. List of GPIB Command Codes

(cont'd)

	Function	Listener code	Talker request		Remarks
			Code	Output format	
Sweep condition	FREE RUN	TM FREE FR	- -	- -	
	LINE	TM LINE LI	- -	- -	
	VIDEO	VI	-	-	
	External	TM EXT EX	- -	- -	
	Trigger slope	+ TRIGSLP + - TRIGSLP -	- -	- -	
	Trigger level	TR*	TR?	-	
	<b>SWP</b>	SW * ST *	SW? ST?	Time Time	
SWP AUTO	AS	AS?	AUTO/MANUAL		
Bandwidth	<b>RBW</b>	RB *	RB?	Frequency	
	RBW AUTO	BA	BA?	AUTO/MANUAL	
	RBW : SPAN	CORS *	CORS?	Ratio	
	RBW : SPAN ON	CORS ON *	-	-	
	RBW : SPAN default	CORS OFF	-	-	
	<b>VBW</b>	VB *	VB?	Frequency	
	VBW AUTO	VA	VA?	AUTO/MANUAL	
VBW : RBW	COVR*	COVR?	Ratio		
VBW : RBW ON	COVR ON*	-	-		
VBW : RBW default	COVR OFF	-	-		
Couple All AUTO	AL	AL?	AUTO/MANUAL		
ATT	<b>ATT</b>	AT *	AT?	Level	
	ATT AUTO	AA	AA?	AUTO/MANUAL	
	MIN. ATT	ATMIN *	ATMIN?	Level	
	MIN. ATT ON	ATMIN ON *	-	-	
MIN. ATT default	ATMIN OFF	-	-		



(cont'd)

Function	Listener code	Talker request		Remarks
		Code	Output format	
<b>Trace A</b>	-	TA?	(Lower byte) 0 : write 1 : view 2 : blank 3 : A-DL→A 4 : A-B→A 5 : B-A→A (Upper byte) 0 : nothing 1 : + max hold 2 : + averaging 3 : + min hold	
A write	AW	-	-	
A view	AV	-	-	
A blank	AB	-	-	
A max hold	AM	-	-	
A min hold	AMIN	-	-	
A averaging	AG *	AG?	Integer	
start	AGR	-	-	
stop	AGS	-	-	
pause	AGP	-	-	
continue	AGC	-	-	
1 time	AG1	-	-	
continue	AG0	-	-	
Trace A clear	CWA	-	-	
<b>Trace Math</b>				
A XCH B	ACHB	-	-	
A-B→A	TR0	-	-	
B-A→A	TR1	-	-	
A-DL→A	TR2	-	-	
<b>Trace B</b>	-	TB?	(Lower byte) 1 : view 2 : blank (upper byte) 0 : nothing	
B store	BSTORE	-	-	
B view	BV	-	-	
B blank	BB	-	-	

5. List of GPIB Command Codes

(cont'd)

	Function	Listener code	Talker request		Remarks
			Code	Output format	
Trace	Measurement point				
	501 point	TPS	-	-	
	1001 point	TPL	-	-	
Trace detector	<b>Detector mode</b>	-	DM?	0: Normal	
		-	DET?	1: Positive	
				2: Negative	
				3: Sample	
	Normal	DTN	-	-	
	Positive	DET NRM	-	-	
	Negative	DTP	-	-	
Limit line	<b>Limit line</b>				
	X-axis				
	ABS	LIMPOS ABS	LIMPOS?	0: ABS	
	REL	LIMPOS REL		1: REL	
	Y-axis				
	ABS	LIMAPOS ABS	LIMAPOS?	0: ABS	
	REL	LIMAPOS REL		1: REL	
Limit line	Limit line 1				
	ON	LAN	LMTA?	ON/OFF	
	OFF	LAF			
	Limit line 2				
Table type selection	ON	LBN	LMTB?	ON/OFF	
	OFF	LBF			
	<b>Table type selection</b>				
	Frequency domain	LIMTYP FREQ	LIMTYP?	0: FREQ	
	Time domain	LIMTYP TIME		1: TIME	
	Limit line 1				
	Table input	LMTAIN * ※	-	-	* = F, L
	Table delete	LMTADEL	-	-	
	Limit line 2				
	Table input	LMTBIN * ※	-	-	* = F, L
Table delete	LMTBDEL	-	-		
X-axis shift	LIMSFT *	LIMSFT?	Frequency or time		
Y-axis shift	LIMASFT *	LIMASFT?	Level		

※: Table data is described following this code for LMTAIN or LMTBIN.  
 Table data is formed by the frequency, time and level.  
 Refer to the programming example of PC-6 (8-45 page) for guideline.

(cont'd)

	Function	Listener code	Talker request		Remarks
			Code	Output format	
Limit line	<b>Pass/Fail judgment</b>				
	Judgment result?	-	PFJ?	0: FAIL 1: PASS	
	Judgment result? (details)	-	OPF?	0: FAIL 1: UPPER 2: LOWER 3: UPPER&LOWER 4: ERROR	
	Read out Fail point Upper side	-	FPU?	The number of Fail point. <CR/FR> + Frequency. Level <CR/LF>.	Maximum 256 sets.
Lower side	-	FPL?	The same as Upper side.		
Display line	<b>Display line</b>	-	DL ?	Level	
	Display line ON	DLN *	-	-	
	Display line OFF	DLF	-	-	
Marker	<b>Marker ON</b>	MN * MKN *	MN? -	0: Marker off 1: Normal marker 2: ΔMarker	
	Marker frequency	-	MF?	Frequency	
	Marker Level	-	ML?	Level	
	Frequency + Level	-	MFL?	Frequency + Level	
	<b>Normal marker</b>	MKN * MK *	- MK?	- Frequency	
	<b>ΔMarker</b>	MKD * MT *	- MT?	- Frequency	
	Fixed Marker	-	FX?	ON/OFF	
	Fixed Marker ON	FXN	-	-	
	Fixed Marker OFF	FXF	-	-	
	1/ΔMarker	-	REDLT?	Operation value (Note)	
	1/ΔMarker ON	REDLT ON	-	-	
	1/ΔMarker OFF	REDLT OFF	-	-	

5. List of GPIB Command Codes

(cont'd)

Function	Listener code	Talker request		Remarks
		Code	Output format	
<b>Signal track</b>	-	SG?	ON/OFF	
Signal track ON	SGN	-	-	
Signal track OFF	SGF	-	-	
<b>Peak Search</b>	MKPK	-	-	
	PS	-	-	
NEXT peak	MKPK NH	-	-	
	NXP	-	-	
NEXT peak left	MKPK NL	-	-	
	NXL	-	-	
NEXT peak right	MKPK NR	-	-	
	NXR	-	-	
MIN search	MIS	-	-	
NEXT MIN	NXM	-	-	
<b>Marker</b> Continuously peak				
Continuously peak ?	-	CP?	ON/OFF	
Continuously peak ON	CPN	-	-	
Continuously peak OFF	CPF	-	-	
<b>Peak range</b>				
Normal	PSN	-	-	
Upper side	PSU	-	-	
Lower side	PSL	-	-	
Peak ΔY div	DY *	DY?	Real value (0.1 to 10)	
<b>Marker display</b>				
Relative value display	MDR	-	-	
Absolute value display	MDA	-	-	
<b>Active marker movement</b>				
Trace A	MKTRACE TRA	MKTRACE?	0 : Blank	
Trace B	MKTRACE TRB	-	1 : Trace A	
			2 : Trace B	
<b>Marker OFF</b>	MKOFF	-	-	
	MO	-	-	

(cont'd)

Function	Listener code	Talker request		Remarks
		Code	Output format	
<b>Multi Marker</b>				
Multi Marker ON	MLT	MLT?	ON/OFF	
Multi Marker OFF	MO	-	-	
Active marker shift	MN *	-	-	* = Frequency
	MK *	-	-	
Multi Marker No.1 ON	MLN1 *	-	-	
Multi Marker No.1 OFF	MLF1	-	-	
Multi Marker No.2 ON	MLN2 *	-	-	
Multi Marker No.2 OFF	MLF2	-	-	
Multi Marker No.3 ON	MLN3 *	-	-	
Multi Marker No.3 OFF	MLF3	-	-	
Multi Marker No.4 ON	MLN4 *	-	-	
Multi Marker No.4 OFF	MLF4	-	-	
Multi Marker No.5 ON	MLN5 *	-	-	
Multi Marker No.5 OFF	MLF5	-	-	
Multi Marker No.6 ON	MLN6 *	-	-	
Multi Marker No.6 OFF	MLF6	-	-	
Multi Marker No.7 ON	MLN7 *	-	-	
Multi Marker No.7 OFF	MLF7	-	-	
Multi Marker No.8 ON	MLN8 *	-	-	
Multi Marker No.8 OFF	MLF8	-	-	
Multi Marker No.9 ON	MLN9 *	-	-	
Multi Marker No.9 OFF	MLF9	-	-	
Multi Marker No.10 ON	MLN10 *	-	-	
Multi Marker No.10 OFF	MLF10	-	-	
Multi Marker all frequency	-	MLSF?	Frequency	10 items + ΔMKR
Multi Marker all level	-	MLSL?	Level	10 items + ΔMKR
Peak list				
Peak list frequency	PLS FREQ	-	-	
Peak list level	PLS LEVEL	-	-	
Peak list off	PLS OFF	-	-	
Peak list output	-	PKLST?	cnt, frequency 1, level1, ...frequency n, leveln: n = cnt	

5. List of GPIB Command Codes

(cont'd)

Function	Listener code	Talker request		Remarks
		Code	Output format	
Marker	MKR→			
	MKR→CF	MKCF MC	- -	- -
	MKR→REF	MKRL MR	- -	- -
	MKR Δ→SPAN	MTSP DS	- -	- -
	MKR→Harm	MKHM MH	- -	- -
	MKR→CF step	MKCS M0	- -	- -
	MKR Δ→CF step	MTCS M1	- -	- -
	MKR Δ→CF	MTCF	-	-
	MKR →MKR step	MKMKS M2	- -	- -
	MKR Δ→MKR step	MTMKS M3	- -	- -
	MKR step size	MPM *	MPM?	Frequency
	MKR step AUTO	MPA	MPA?	AUTO/MANUAL
	PEAK →CF	PKCF	-	-
	PEAK →REF	PKRL	-	-
dB down	X dB down width	MKBW *	MKBW?	Level
	X dB down	XDB	-	-
	X dB down left	XDL	-	-
	X dB down right	XDR	-	-
	X dB relative	DC0	-	-
	X dB abs. left	DC1	-	-
	X dB abs. right	DC2	-	-

(cont'd)

	Function	Listener code	Talker request		Remarks
			Code	Output format	
Marker	X dB execution state	-	DC?	0 : Relative 1 : Absolute (Left) 2 : Absolute (Right)	
	Continuously dB down?	-	CDB?	OFF/ON	
	Continuously dB down ON Continuously dB down OFF	CDB ON CDB OFF	- -	- -	- -
Measurement window	<b>Measurement window</b>	-	WDO? WN?	ON/OFF ON/OFF	
	Window ON	WDO ON WN	- -	- -	
	Window OFF	WDO OFF WF	- -	- -	
	Center position : X	WLX *	WLX?	Frequency	
	Window width	WDX *	WDX?	Frequency	
	Couple to Marker	CPLMK ON CPLMK OFF	CPLMK? -	ON/OFF -	
	Multi-screen	Multi-screen			
Multi-screen ZOOM		MLTSCR ZM	-	-	
Multi-screen F/T		MLTSCR FT	-	-	
Multi-screen RESET		MLTSCR RST	-	-	
Window position		ZMPOS *	ZMPOS?	Frequency or time	
Window width		ZMWID *	ZMWID?	Frequency or time	
Input	Upside screen	SCRSEL TRA	-	-	
	Downside screen	SCRSEL TRB	-	-	
	Level Correction		CR?	ON/OFF	
	ON	CR ON	-	-	
OFF	CR OFF	-	-		
Recall	table input	CRIN * ※	-	-	* = F,L
	table deletion	CRDEL	-	-	
Save	<b>Recall</b>	RC/REG_nn/ RC/File name/	- -	- -	Max eight characters for the file name.
	<b>Save</b>	SV/REG_nn/ SV/File name/	- -	- -	"nn" of "REG_nn" is from 01 to 10.
Delete	<b>Delete</b>	DEL/REG_nn/ DEL/File name/	- -	- -	
Reset	<b>Instrument Preset</b>	IP	-	-	

※: CRIN sets the rable data after this code. The table data is organized with the frequency and the level.

5. List of GPIB Command Codes

(cont'd)

	Function	Listener code	Talker request		Remarks
			Code	Output format	
Printer	<b>Printer output</b>				
	Gradation mode	PRT GRY	-	-	
	No gradation standard	PRT MOL	-	-	
	reduction	PRT MOS	-	-	
	Printer command selection				
	ESC/P	PRTCMD ESC	-	-	
	HP PCL	PRTCMD PCL	-	-	
Execution	HCOPY	-	-		
Plotter	<b>Plotter output</b>				
	The object to be plotted				
	All information	PLALL	-	-	
	Only wave form	PLTRACE	-	-	
	Split size				
	Full size	PLPIC1	-	-	
	Two part split	PLPIC2	-	-	
	Four part split	PLPIC4	-	-	
	Plot positions				
	Center	PLMID	-	-	Mode changes to full size.
	Left	PLLEFT	-	-	Mode changes to the two part split.
	Right	PLRIGHT	-	-	Mode changes to four part split.
	Upper left	PLUPLEFT	-	-	
	Upper right	PLUPRIGHT	-	-	
	Lower left	PLLOWLEFT	-	-	
	Lower right	PLLOWRIGHT	-	-	
	Moving for plot positions				
	Automatic	PLAUTO	-	-	
	Manual	PLMAN	-	-	
	Address mode				
Specifying talk only mode	PLTALK ONLY	-	-	Specifying talker and listener address is necessary by the controller.	
Address	PLTALK ADRS	-	-		



(cont'd)

	Function	Listener code	Talker request		Remarks
			Code	Output format	
Plotter	Execution plot	PLOT	-	-	Plot is carried out from OPT15.
		HCOPY	-	-	
		OPTPLOT	-	-	
Bit map file	Image mode				*: Specify file No by HCFILE before execution three digit integer of 000 to 999.
	Color	HCIMAG COL	-	-	
	Gray scale monochrome	HCIMAG GRY	-	-	
	RLE compression	HCIMAG MON	-	-	
	Off	HCCMPRS OFF	-	-	
	On	HCCMPRS ON	-	-	
	File No.	HCFILE *	-	-	
	Execution	HCOPY	-	-	
Hard copy control	Device selection				MA: Memory card drive A MB: Memory card drive B
	Printer	HCDEV PRT	-	-	
	Plotter	HCDEV PLT	-	-	
	File A	HCDEV MA	-	-	
	File B	HCDEV MB	-	-	
	Execution hard copy	HCOPY	-	-	
Calibration	<b>Calibration</b>				Other commands are invalid during the execution of CAL.
	CAL ALL	CLA	-	-	
	Total gain cal.	CLG	-	-	
	Input ATT cal.	CLATT	-	-	
		IT0	-	-	

※: CRIN sets the rate data after this code. The table data is organized with the frequency and the level.

5. List of GPIB Command Codes

(cont'd)

Function	Listener code	Talker request		Remarks	
		Code	Output format		
Calibration	IF step AMP cal.	CLSTEP	-	-	Other commands are invalid during the execution of CAL
		IT1	-	-	
	RBW switch cal.	CLRBW	-	-	
		IT2	-	-	
	Log linearity cal	CLLOG	-	-	
		IT3	-	-	
	AMPTD MAG cal.	CLMAG	-	-	
		IT4	-	-	
	PBW cal.	CLPBW	-	-	
		IT6	-	-	
	Calibration level	CLN*	CL?	Level (-10 to -30 dB) (0.5 dB Step)	
	f compensation	-	FC?	ON/OFF	
	f compensation ON	FC ON	-	-	
		FCN	-	-	
	f compensation OFF	FC OFF	-	-	
		FCF	-	-	
	CAL compensation	-	CC?	ON/OFF	
	CAL compensation ON	CC ON	-	-	
	CCN	-	-		
CAL compensation OFF	CC OFF	-	-		
	CCF	-	-		
Calibration of the internal reference	CLREF * CLREF 9999	CLREF? -	Integer (-100 to 100) -	Record for setup value	
Memory card	<b>Memory card</b>				MA: (A:) or MB: (B:) is available for the drive name.
	Memory card initialization	MMI /A: / MMI /B: /	-	-	
	ALL copy	ALLCOPY /A: B: /	-	-	
	Drive select	DEV /RAM: / DEV /A: / DEV /B: /	-	-	
Label	<b>Label</b>	-	LB?	Character string	Max.30 characters Enclose a character with a slash (/). Note: End with the character unable to display.
	Label ON	LON /*** /	-	-	
	Label deletion	LOF	-	-	

(cont'd)

	Function	Listener code	Talker request		Remarks
			Code	Output format	
Soft key	<b>Data input correspondence</b>				
	0 to 9	0 to 9	-	-	
	.(decimal point)	.	-	-	
	GHz	GZ	-	-	
	MHz	MZ	-	-	
	kHz	KZ	-	-	
	Hz	HZ	-	-	
	mV	MV	-	-	
	mW	MW	-	-	
	dB ratio	DB	-	-	
	mA	MA	-	-	
	Second	SC	-	-	
	Milli second	MS	-	-	
	Micro second	US	-	-	
ENTER	ENT	-	-		
Trace data	<b>Trace data I/O</b>				
	Memory A output (ASCII)	-	TAA?	5 bytes + delimiter	1 point
	(BINARY)	-	TBA?	2 bytes × 1001 (or 501) points	EOI signal
	Memory B output (ASCII)	-	TAB?	5 bytes + delimiter	1 point
	(BINARY)	-	TBB?	2 bytes × 1001 (or 501) points	EOI signal
	Memory A input (ASCII)	TAA	-	-	1 point
	(BINARY)	TBA	-	-	EOI signal
	Memory B input (ASCII)	TAB	-	-	1 point
(BINARY)	TBB	-	-	EOI signal	
Spectrum	<b>Power Meas</b>				
	Average Time	PWTM *	PWTM?	Integer(1 to 999)	
	Average Power ON	PWAVG ON	-	-	
	Average Power OFF	PWAVG OFF	-	-	
	Average Power?	-	PWAVG?	Level	
	Total Power ON	PWTOTAL ON	-	-	
	Total Power OFF	PWTOTAL OFF	-	-	
Total Power?	-	PWTOTAL?	Level		

5. List of GPIB Command Codes

(cont'd)

Function	Listener code	Talker request		Remarks	
		Code	Output format		
Channel Power ON	PWCH ON	-	-		
Channel Power OFF	PWCH OFF	-	-		
		PWCH?	Level		
Carrier Power ON	PWCARR (PS)	PWCARR? (MF?) (ML?)	Level Frequency Level		
<hr/>					
<b>Counter</b>	-	COUNT?	ON/OFF		
Counter value	-	CNRES?(MF?)	Frequency		
Counter ON	COUNT ON	-	-		
Resolution : 1 kHz	CN0	-	-		
100 Hz	CN1	-	-		
10 Hz	CN2	-	-		
1 Hz	CN3	-	-		
Counter OFF	COUNT OFF	-	-		
	CNF	-	-		
<hr/>					
Spectrum	<b>Sound Mode</b>	-	SDMD? SD?	0 : OFF 1 : ON(AM) 2 : ON(FM)	
	Sound ON(AM or FM)	SON	-	-	
	Sound ON(AM)	SAM	-	-	
	Sound ON(FM)	SFM	-	-	
	Sound OFF	SOF	-	-	
	Volume	SDV *	SDV?	Integer	1 to 8
	Volume(Maximum)	VX	-	-	
	Volume(Middle)	VD	-	-	
	Volume(Minimum)	VN	-	-	
	Pause time	PU *	PU?	Time	
	SQELCH	SQE *	SQE?	Level	
	SQELCH ON	SQE ON *	-	-	
	SQELCH OFF	SQE OFF	-	-	
	<hr/>				
	<b>Noise/Hz</b>	NI *	NI?	Frequency	
dBm/Hz ON	NIM	-	-		
$\text{dB}\mu\text{V}/\sqrt{\text{Hz}}$ ON	NIU	-	-		
dBc/Hz ON	NIC	-	-		
Noise/Hz OFF	NIF	-	-		
Noise/Hz value	-	NIRES? (ML?)	Level		

(cont'd)

Function	Listener code	Talker request		Remarks
		Code	Output format	
<b>Misc</b>				
Error Number output	-	ERRNO?	Integer	Refer to error numbers of the message list.
Delimiter				
CR LF <EOI>	DL0	-	-	
LF	DL1	-	-	
<EOI>	DL2	-	-	
CR LF	DL3	-	-	
LF <EOI>	DL4	-	-	
Service request				
Interruption ON	S0	-	-	
Interruption OFF	S1	-	-	
Status clear	S2	-	-	
Service request mask	RQS *	RQS?	Decimal corresponding to SRQ bit	
Product type	-	VER?	-	
Product type (character strings)	-	TYPE?	character strings + delimiter	
	-	TYP?	character strings + delimiter	
Revision output	-	REV?	character strings + delimiter	
Reference signal source				
(Internal)	RFI	-	-	
(External)	RFE	-	-	
CW-OBW				
OBW (execute)	OBW	OBW?	<OBW %, OBW value, FC>	OBW % [%]
OBW %	OBW *	-	-	OBW value [Hz]
OBW avg times	AVGOBW *	AVGOBW?	Integer	FC [Hz]
OBW avg times ON	AVGOBW ON	-	-	
OBW avg times OFF	AVGOBW OFF	-	-	
OBW set up (User)	OBWST USR	-	-	
(Define)	OBWST DEF	-	-	
(Manual)	OBWST MNL	-	-	
(STD)	OBWST STD	-	-	

5. List of GPIB Command Codes

(cont'd)

Function	Listener code	Talker request		Remarks
		Code	Output format	
Misc	CW-ACP			l1 to u3 [dB]
	ACP (execute)	ACP	ACP?	<l1, u1,l2, u2, l3, u3 >
	ACP CS	ADCH *	-	-
	ACP BS	ADBS *	-	-
	ACP set up (User)	ACPST USR	-	-
	(Define)	ACPST DEF	-	-
	(Manual)	ACPST MNL	-	-
	(STD)	ACPST STD	-	-
	ACP screen (Full)	ACPSCR FULL	-	-
	(Sepa)	ACPSCR SEPA	-	-
ACP graph ON	ADG ON	-	-	
OFF	ADG OFF	-	-	
CW-HARM				f [Hz] l [level unit] Combine f and l as one set. Max. 10 set output Number of set equals number of HRMNUM?.
HARM (execute)	HARM	HARM?	<f1, l1,f2, l2, ... f10, l10 >	
HARM Fund	HRMFND *	HRMFND?	Frequency	
HARM Number	HRMNUM *	HRMNUM?	Integer	
Common command	Device ID output	-	*IDN?	Maker name (character string) Device type (character string) 0, revision (character string) (Example: ADVANTEST, R3465, 0, A01)
	Device initialization	*RST	-	-
	Clearing of status bytes and related queues	*CLS	-	-
	Accessing of standard event status enable register	*ESE	*ESE?	Decimal number corresponding to each bit in the register
	Reading and clearing of standard event status enable register	-	*ESR?	Decimal number corresponding to each bit in the register
	Accessing of service request enable register	*SRE	*SRE?	Decimal number corresponding to each bit in the register
	Reading of status byte and MSS bit	-	*STB?	Decimal number corresponding to each bit of status byte
	Accessing of operation status enable register	OPR	OPR?	Decimal number corresponding to each bit in the register
Reading and clearing of operation status register		OPREVT?	Decimal number corresponding to each bit in the register	

## ■ GPIB code of TRANSIENT mode

Function	Listener code	Talker request		Remarks	
		Code	Output format		
Operation mode	CW	SETFUNC CW	SETFUNC?	0 : CW	
	TRAN	SETFUNC TRAN		1 : TRANSIENT	
Communication system	PDC	MODTYP PDC	MODTYP?	0 : PDC	
	PHS	MODTYP PHS		1 : PHS	
	NADC	MODTYP NADC		2 : NADC	
Communication direction	UP	LINK UP	LINK?	0 : UP	
	DOWN	LINK DOWN		1 : DOWN	
	VOX	LINK VOX		2 : VOX	
Communication rate	FULL	CODEC FULL	CODEC?	0 : FULL	
	HALF	CODEC HALF		1 : HALF	
Sync word	PDC	SYNC Sn(n:1-12)	SYNC?	0 : S1	
	NADC	SYNC Sn(n:1-6)		5	
	None	SYNC NO		11 : S12	
Unique word	PHS-16b	UNIQ B16	UNIQ?	0 : B32	
	PHS-32b	UNIQ B32		1 : B16	
	None	UNIQ NO			
Burst number	1-burst	NBURST B1	NBURST?	0 : B1	
	10-burst	NBURST B10		1 : B10	
Signal type					(PHS only)
Continuous wave		MEASMD CONT	MEASMD?	0 : BURST	
	Burst wave	MEASMD BURST		1 : CONT	
Root nyquist filter		RNYQ ON RNYQ OFF	RNYQ?	ON/OFF	
Measurement frequency range					
NORMAL		FRRNG NORM	FRRNG?	0 : NORM	
	EXPAND	FRRNG EXP	-	1 : EXP	
Auto level					
Execution (Except waveform)		AUTOLVL	-	-	
Execution (Waveform)		AUTOWFL	-	-	
Auto Level ON		ALS ON	-	-	
Auto Level OFF		ALS OFF			
Standard type					(PDC only)
RCR-27B		RCR27B	-	-	
RCR-27C		RCR27C	-	-	

5. List of GPIB Command Codes

(cont'd)

Function		Listener code	Talker request		Remarks	
			Code	Output format		
Average						
	OBW	TAVGOBW *	TAVGOBW?	Integer		
	ACP	TAVGACP *	TAVGACP?	Integer		
	Mod Acc	TAVGMOD *	TAVGMOD?	Integer		
	Transfer Rate	TAVGTR *	TAVGTR?	Integer		
		*:1 to 32, 1:OFF				
	Antenna Power	TAVGAP *	TAVGAP?	Integer		
	Carrer Off Power	TAVGCR *	TAVGCR?	Integer		
Measurement conditions	Trigger					
	Mode	AUTO	TRGMODE AUTO	-	-	
		EXT	TRGMODE EXT	-	-	
		SOFTWARE	TRGMODE SOFT	-	-	
	EXT Trigger Slope	+	TRGMSLP RISE	-	-	
		-	TRGMSLP FALL	-	-	
	Source	FREE	TRGSRC FREE	-	-	
		VIDEO	TRGSRC VIDEO	-	-	
		IF	TRGSRC IF	-	-	
		EXT	TRGSRC EXT	-	-	
	Slope	+	TRGSLP RISE	-	-	
		-	TRGSLP FALL	-	-	
	Level		TRGLVL *	-	-	Integer (0 to 100)
			*:%			
	Source Monitor	ON	TRGMON ON	-	-	
		OFF	TRGMON OFF	-	-	
		ON/OFF?	-	TRGMON?	0 : OFF 1 : ON	
	Position		TRGPOS *	-	-	Integer (0 to 100)
		*:%				
Delay Time		TRGDT *	TRGDT?	Time		
Limit Line	Copy Table	LMCPSL STD	-	-		
		LMCPSL USR	-	-		



(cont'd)

Function	Listener code	Talker request		Remarks
		Code	Output format	
Display Control				
Window position	DCPOS *	DCPOS?	Time	
Window width	DCWID *	DCWID?	Time	
T-Zoom ON	DCZOM	-	-	
T-Zoom Reset	DCRST	-	-	
Spurious				
Recall Table	RCLSTBL 1/2/3	-	-	
Save Table	SAVSTBL 1/2/3	-	-	
Edit Table	SPUFREQ *1, *2 *1:F1 to F15 *2:Frequency	-	-	
Delete Table	DELSTBL	-	-	Deletes a selected table.
Spurious Trigger				
Mode	AUTO	TRSPMD AUTO	-	
	EXT	TRSPMD EXT	-	
EXT Slope	+	TRSPSLP RISE	-	
	-	TRSPSLP FALL	-	
Carrier OFF Trigger				
Mode	AUTO	TRCRMD AUTO	-	
	EXT	TRCRMD EXT	-	
EXT Slope	+	TRCRSLP RISE	-	
	-	TRCRSLP FALL	-	
ACP measurement mode	FREQ	TACPMD FREQ	-	
	TIME	TACPMD TIME	-	
IN-BAND Spurious				
Extended Span	IBEXSP *	IBEXSP?	Frequency	

5. List of GPIB Command Codes

(cont'd)

	Function	Listener code	Talker request		Remarks	
			Code	Output format		
Measurement conditions	PASS/FAIL				PASS/FAIL testing is available to use in CW mode.	
	Test	ON	PFC ON	-		-
		OFF	PFC OFF	-		-
	Continuous mode?		-	PFC?		0 : OFF 1 : ON
	Screen selection (when two screens are displayed)			-		-
	Upside screen		PFJ A	-		-
	Downside screen		PFJ B	-		-
Test conclusion?		-	PFJ?	0 : FAIL 1 : PASS		
Test conclusion? (Details)		-	OPF?	0 : PASS 1 : UPPER 2 : LOWER 3 : UPPER&LOWER 4 : ERROR		
Measurement result	ACP (PDC/PHS)	-	TACP?	< bpwr, pl1, pl2, pu1, pu2, ml1, ml2, mu1, mu2 >	PDC/PHS pl1 to mu2 [dB]	
	ACP (NADC)	-	TACP?	< bpwr, pl1, pl2, pl3, pu1, pu2, pu3, ml1, ml2, ml3, mu1, mu2, mu3 >	NADC pl1 to mu3 [dB] bpwr is always 0.	
				* Output the resulted value to Peak Data position (pl-n, pu-n) when the mode is FREQ.		

(cont'd)

Function	Listener code	Talker request		Remarks	
		Code	Output format		
Waveform	WAVEFM	-	-		
Spectrum	SPCT	-	-		
OBW	TOBW	-	-		
ACP	TACP	-	-		
Spurious	SPUR	-	-		
Antenna Power	TXPWR	-	-		
Carrier OFF Power	OFFPWR	-	-		
Modulation Accuracy	MODACC	-	-		
Transfer Rate	BTR	-	-		
IN-BAND Spurious	IBSPR	-	-		
Measurement of the same item	SI	-	-		
Measurement start	OBW	-	TOBW?	Frequency	
		-	TOBW2?	< obw, fc, power > (Hz, Hz, dBm)	
	ACP	-	TACP?	< bpwr, pl1, pl2, pu1, pu2, ml1, ml2, mu1, mu2 >	pl1 to mu2 [dB]
	Burst Amp Droop	-	BUDRP?	Level [dB/symbol]	bpwr is always 0.
	Frequency Error	-	FREQERR?	Frequency	
	I/Q Origin Offset	-	IQOFS?	Level [dB]	
	Magnitude Error	-	MAGERR?	Numerical value [%]	
	Phase Error	-	PHERR?	Phase [degree rms]	
	Error Vector Mag.	-	ERRVECT?	Numerical value[% , rms]	
	Bit Rate Error	-	BITRERR?	n1, n2 (% , Hz)	
	Carrier OFF Power	-	OFFPWR?	p1, p2 (dBm, nW)	
	Antenna Power	-	TXPWR?	< Ap1, Ap2, Fp1, Fp2 > (dBm, mW, dBm, mW)	
	Spurious	-	SPULVL?	< N-point, f1, l1,.. fn, ln >	f [Hz] l [dBm]
	Mod Accuracy	-	MODACC?	< BADroop, F. Err, IQ-off, Mag-err, Ph-err, EVM >	
	IN-BAND Spurious	-	IBSPR?	< N-point, f1, l1,.. fn, ln >	

## 6. Sample programs

N88BASIC is used in PC9801 series and HP-BASIC is used in HP200 and 300 series.

Sample programs for PC9801 series (GPIB address = 8)

Example PC-1 : Master reset the instrument and set center frequency to 30 MHz.

```

10 ISET IFC:ISET REN      ' Execute interface clear and remote enable.
20 PRINT @8;"IP"         ' Execute master reset.
30 PRINT @8;"CF30MZ"     ' Set center frequency to 30 MHz.
40 STOP
50 END

```

Example PC-2 : Set start frequency to 300 kHz and stop frequency to 800 kHz, and add 50 kHz as frequency offset.

```

10 ISET IFC:ISET REN      '
20 PRINT @8;"FA300KZ"     ' Set start frequency to 300 kHz.
30 PRINT @8;"FB800KZ"     ' Set stop frequency to 800 kHz.
40 PRINT @8;"FON50KZ"     ' Set frequency offset to 50 kHz.
50 STOP
60 END

```

Example PC-3 : Set reference level to 87 dB $\mu$ V, 5 dB/div and RBW to 100 kHz.

```

10 ISET IFC:ISET REN      '
20 PRINT @8;"UU RL87DB"   ' Set REF level to 87 dB $\mu$ V.
30 PRINT @8;"DD5DB"       ' Set 5 dB/div.
40 PRINT @8;"RB100KZ"     ' Set RBW to 100 kHz.
50 STOP
60 END

```

Example PC-4 : Assign numeric value to variable.

```

10 ISET IFC:ISET REN      '
20 SPA = 8:A = 10:B = 2:C = 20 ' Assign a set value to each variable.
30 PRINT @SPA;"CF",A,"MZ" ' Set center frequency to 10 MHz.
40 PRINT @SPA;"SP",B,"MZ" ' Set frequency span to 2 MHz.
50 PRINT @SPA;"AT",C,"DB" ' Set ATT to 20 dB.
60 STOP
70 END

```

Example PC-5 : Save set data to or recall it from register 5.

```

10 ISET IFC:ISET REN
20 TITLE$ = "R3465 SPECTRUM Analyzer"
30 PRINT @8;"CF30MZ SP1MZ DTP"
40 PRINT @8;"LON/" + TITLE$ + "/"
50 PRINT @8;"SV/REG_05/"
60 PRINT @8;"CF1GZ SP200MZ"

70 PRINT @8;"RC/REG_05/"
80 STOP
90 END

```

' Define a label.  
' Set each data.  
' Label ON  
' Save values in register 5.  
' Change center frequency and frequency span.  
' Recall values from register 5.

Example PC-6 : Input data to the table for limit line 1 and turn limit line 1 ON.

```

10 ISET IFC:ISET REN
20 PRINT @8;"IP"
30 PRINT @8;"LMTADEL"
40 PRINT @8;"UU"
50
60 PRINT @8;"LMTAIN 25MZ,49.5DB"
70 PRINT @8;"LMTAIN 35MZ,50.5DB"
80 PRINT @8;"LMTAIN 35MZ,51.5DB"
90 PRINT @8;"LMTAIN 55MZ,52.5DB"
100 PRINT @8;"LMTAIN 55MZ,54.3DB"
110 PRINT @8;"LMTAIN 65MZ,55.9DB"
120 PRINT @8;"LMTAIN 65MZ,57.0DB"
130 PRINT @8;"LMTAIN 68MZ,58.0DB"
140 PRINT @8;"LMTAIN 68MZ,60.5DB"
150 PRINT @8;"LMTAIN 75MZ,63.0DB"
160 PRINT @8;"LMTAIN 75MZ,64.0DB"
170 PRINT @8;"LMTAIN 82MZ,64.6DB"
180 PRINT @8;"LMTAIN 82MZ,64.7DB"
190
200 PRINT @8;"FA0MZ FB100MZ"
210 PRINT @8;"LAN"
220 STOP
230 END

```

' Delete the table for limit line 1.  
' Set units to dB $\mu$ V.  
' Input data for limit line 1.  
' Set start frequency and stop frequency.  
' Turn limit line 1 ON.

## 6. Sample programs

Example PC-7 : Sample measurement with gated sweep

```

10 ISET IFC:ISET REN           ' Execute interface clear and remote enable.
20 PRINT @8;"GTSRC GT"         ' Set gate signal source to EXT.
30 PRINT @8;"GTSLP +"         ' Set trigger at the trailing edge of EXT signal.
40 PRINT @8;"GTWID 10MS"       ' Set gate width to 10 ms.
50 PRINT @8;"GTPOS 10US"       ' Set gate position to 10 us.
60 PRINT @8;"GTSWP ON"        ' Turn gated sweep ON.
70 END

```

Sample programs for HP200 and HP300 series (GPIB address = 1)

Example HP-1 : Master reset the instrument and set center frequency to 30 MHz.

```

10 OUTPUT 701;"IP"
20 OUTPUT 701;"CF30MZ"
30 END

```

Example HP-2 : Set start frequency to 300 kHz and stop frequency to 800 kHz, and add 50 kHz as frequency offset.

```

10 OUTPUT 701;"FA300KZ"
20 OUTPUT 701;"FB800KZ"
30 OUTPUT 701;"FON50KZ"
40 END

```

Example HP-3 : Set reference level to -20 dBm (5 dB/div), resolution bandwidth to 100 kHz and detector mode to Posi.

```

10 OUTPUT 701;"RL-20DB"
20 OUTPUT 701;"DD5DB"
30 OUTPUT 701;"RB100KZ"
40 OUTPUT 701;"DTP"
50 END

```

Example HP-4 : Set trigger mode to SINGLE and sweep time to 2 seconds, and position a marker at the maximum level for each sweep.

```
10 OUTPUT 701;"SI"  
20 OUTPUT 701;"SW2SC"  
30 OUTPUT 701;"SR"           ! Start sweep.  
40 WAIT 2.5                   ! Wait for sweep end (or use service request).  
50 OUTPUT 701;"PS"           ! Marker peak search  
60 GOTO 30  
70 STOP  
80 END
```

Example HP-5 : Set to MAX HOLD (A).

```
OUTPUT 701;"AM"           ! Set to DIRECT.
```

Example HP-6 : Accessing the files

```
OUTPUT 701;"RC/REG_05/"           ! Recall the register 5.  
OUTPUT 701;"RC/A: \SVRCL \FILE_010.DAT/" ! Recall values from the card.  
OUTPUT 701;"SV/REG_02,PDC Measure/" ! Save values with the titles.
```

**Note**

*The method of accessing files with RC, DEL, SV command is in the same format.*

*To specify the device name, be sure to specify its full pass name including the directory name.*

## ■ Data output format (talker)

In order to output internal data such as measured data and set conditions, it is necessary to specify which data to output with "xx?" command. Then the specified data is read when the instrument is in talker mode. Available output formats are as shown in the table below. The delimiter positioned at the end of data can be specified from 5 types (see the item "Others" in GPIB code list). Once set, "xx?" command continues to be valid until it is changed the next.

(1 of 2)

	Output format
Frequency	$\pm$ <u>DDDDDDDDDD</u> <u>E</u> $\pm$ <u>D</u> <u>CR LF</u> ↑                    ↑                    ↑    ↑ 1                    2                    3    4
	<ul style="list-style-type: none"> <li>Data size (1 to 3) is maximum 19 bytes, and the unit is Hz.</li> </ul>
	Example) Specify "CF?" and output as center frequency.
Level	$\pm$ <u>DDDDDDDD</u> <u>E</u> $\pm$ <u>D</u> <u>CR LF</u> ↑            ↑            ↑    ↑ 1            2            3    4
	<ul style="list-style-type: none"> <li>Data size (1 to 3) is maximum 19 bytes, and the unit corresponds to each UNIT setting.</li> </ul>
	Example) Specify "ML?" and output as maker level.

< Supplement >

- 1 = Sign (a space for plus sign; "-" for minus sign)
- 2 = Mantissa of data
- 3 = Exponent of data
- 4 = Delimiter (CR/LF in initial setting and it can be changed with "DLn" code.)



(2 of 2)

	Output format
Time	$\pm$ <u>DDDD</u> <u>E</u> $\pm$ <u>D</u> <u>CR LF</u> ↑ ↑ ↑ ↑ 1 2 3 4 ● Data size (1 to 3) is maximum 19 bytes, and the unit is sec. Example) Specify "SW?" and output sweep time.
Constant	<u>DDDD</u> <u>CR LF</u> ↑ ↑ 2 4 ● The maximum byte of the data size corresponds to the maximum size of the output data. Example) ON/OFF status is output or Averaging count is output.

## &lt; Supplement &gt;

- 1 = Sign (a space for plus sign; "-" for minus sign)
- 2 = Mantissa of data
- 3 = Exponent of data
- 4 = Delimiter (CR/LF in initial setting and it can be changed with "DLn" code.)

## 6. Sample programs

Sample programs for PC9801 series (GPIB address = 8)

Example PC-8 : Output marker level (numerical variable)

```

10 ISET IFC:ISET REN      '
20 PRINT @8;"CF30MZ SP1MZ MK30MZ" ' Center frequency, frequency span, marker
                                ON
30 PRINT @8;"ML?"        ' Marker level?
40 INPUT @8;ML           ' Read marker level.
50 PRINT "MARKER LEVEL = ",ML ' Display the result.
60 STOP
70 END

```

Sample result: MARKER LEVEL = -16.22

Example PC-9 : Output center frequency (character variable)

```

10 ISET IFC:ISET REN      '
20 PRINT @8;"CF?"
30 INPUT @8;CF$          ' Read center frequency.
40 PRINT CF$              ' Display the result.
50 STOP
60 END

```

Sample result: 30.000E + 6

Example PC-10: Output level and its unit

```

10 ISET IFC:ISET REN      '
20 PRINT @8;"RL?"
30 INPUT @8;RE$          ' Read REF level.
40 PRINT @8;"UN?"
50 INPUT @8;UN           ' Read unit for level.
60 PRINT RE$," : ",UN    ' Display the result.
70 STOP
80 END

```

Sample result: 0.0E + 0 : 0

Example PC-11: Execute 6 dB down and then output frequency and level values (multiple items).

```

10 ISET IFC:ISET REN           '
20 PRINT @8;"CF30MZ SP20MZ"    '   Set center frequency and frequency span.
30 PRINT @8;"MKBW6DB PS XDB"   '   Execute 6 dB down.
40 PRINT @8;"MFL?"             '   Read frequency and level for marker position
50 INPUT @8;MF,ML              '   at the same time.
60 PRINT "MARKER FREQ = ";MF;" : MARKER LEVEL = ";ML
70 STOP
80 END

```

Sample result: MARKER FREQ = 400000 : MARKER LEVEL = 1.16

Example PC-12: Execute CW-OBW and output the result.

```

10 ISET IFC:ISET REN           '
20 PRINT @8;"CF30MZ"           '   Set center frequency and frequency span
30 PRINT @8;"SP10MZ"
40 PRINT @8;"MK30MZ"
50 PRINT @8;"OBW"              '   Read peak level.
60 PRINT @8;"OBW?"
70 INPUT @8;PER,OBW,FC         '   Read 2nd peak level.
80 PRINT "OBW (";PER;"%) = ";OBW;" : Fc = ";FC
90 STOP
100 END

```

Sample result: OBW(99%) = 171000 : Fc = 2.503E + 07

## 6. Sample programs

Example PC-13: Output level values for the maximum, 2nd and 3rd peak points of the signal.

```
10 ISET IFC:ISET REN           '
20 PRINT @8;"CF0MZ"           ' Set center frequency and frequency span
30 PRINT @8;"SP100MZ"
40 PRINT @8;"PS"
50 INPUT @8;"ML?"
60 INPUT @8;A                 ' Read peak level.
70 PRINT @8;"NXP"
80 INPUT @8;"ML?"
90 INPUT @8;B                 ' Read 2nd peak level.
100 PRINT @8;"NXP"
110 INPUT @8;"ML?"
120 INPUT @8;C                ' Read 3rd peak level.
130 PRINT "1st PK = ";A;" : 2nd Pk = ";B;" : 3rd PK = ";C
140 STOP
150 END
```

Sample result: 1st PK = -9.44 : 2nd PK = -10.06 : 3rd PK = -11.84

Example HP-7 : Output marker frequency (integer).

```
10 OUTPUT 701;"MF?"
20 ENTER 701;A
30 END
```

Sample result:  $A = 1.8E + 9$

Example HP-8 : Output center frequency (character string).

```
10 DIM A$(30)
20 OUTPUT 701;"CF?"
30 ENTER 701;A$
40 END
```

Sample result:  $A\$ = 1.234567E + 9$

Example HP-9 : Output status of the level unit.

```
10 OUTPUT 701;"UN?"
20 ENTER 701;A
30 END
```

Sample result:  $A = 2$  (dBuV)

Example HP-10: Output frequency and level values for marker position at the same time (multiple values).

```
10 OUTPUT 701;"MFL?"
20 ENTER 701;Mf,MI
30 END
```

Sample result:  $Mf = 1.8E + 9$   $MI = -65.15$

Example HP-11: With NEXT PEAK function, read 2nd and following 10 peak levels of the signal.

```
10 DIM MI(9)
20 OUTPUT 701;"PS"
30 FOR I=0 TO 9
40 OUTPUT 701;"NXP"
50 OUTPUT 701;"ML?"
60 ENTER 701;MI(I)
70 NEXT I
80 END
```

Sample result:  $MI(0) = -55.01$   $MI(1) = -58.22$  -- $MI(9) = -70.26$

6. Sample programs

■ I/O of trace data

Trace data on the screen includes the data for 1001 or 501 points on frequency axis. For inputting/outputting these data, it is necessary to transfer data for 1001/501 points from leftmost one (start frequency) in order. Each level point is expressed by an integer from 1792 to 14592. (However, when the waveform exceeds the upper limit of the vertical scale, a value greater than 14592 is transferred.)

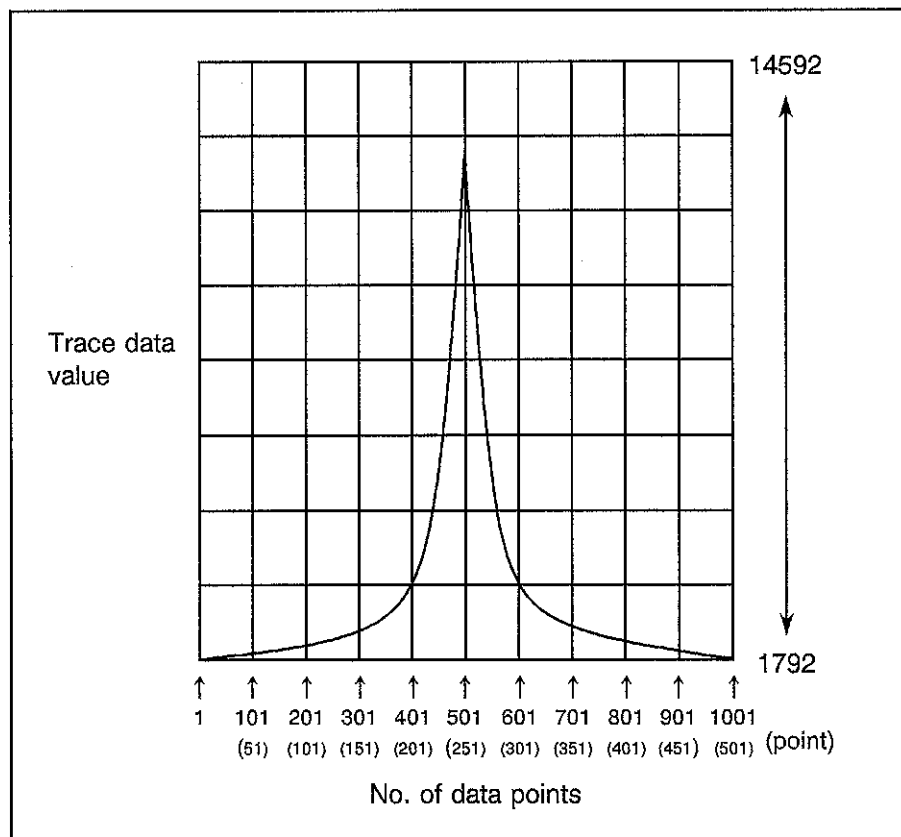

Figure 8-1 Relation between screen grid and trace data

ASCII format and binary format are available for the input and output of the trace data.

Table 8-1 Trace accuracy designation code

GPIB code	Content
TPS	Set the number of measuring points to 501.
TPL	Set the number of measuring points to 1001.



## 6. Sample programs

Sample programs for PC9801 series (GPIB address = 8)

Example PC-14: Output data from memory A in ASCII format.

```

10 ISET IFC:ISET REN           ' Execute interface clear and remote enable.
20 DIM TR(1001)
30 PRINT @8;"DL0 DTG"         ' Set to negative detector.
40 PRINT @8;"TAA?"           ' Specify ASCII output from memory A.
50 FOR I=0 TO 1000
60   INPUT @8;TR(I)           ' Fetch data for 1001 points.
70   PRINT I;"="";TR(I)
80 NEXT I
90 END

```

Sample result: Tr(0) = 5208 Tr(1) = 5210 .... Tr(999) = 5311 Tr(1000) = 5298

Example PC-15: Output data from memory A in binary format.

```

10 ISET IFC:ISET REN           ' Execute interface clear and remote enable.
20 DIM TR(1001)
30 PRINT @8;"DL2 DTG"         ' Set to negative detector.
40 PRINT @8;"TBA?"           ' Specify binary output from memory A.
50 WBYTE &H3F,&H5F,&H3E,&H48;   ' Cancel listener and address PC9801 to #30 as
60                                     ' listener and this device to #8 as talker.
70 FOR I=0 TO 1000
80   RBYTE ;UP,LO             ' Repeat fetching data, high-order bytes for 1001
90   TR(I) = UP*256 + LO       ' points and then low-order bytes for 1001 points.
100  PRINT I;"="";TR(I)
110 NEXT I
120 WBYTE &H3F,&H5F;           ' Cancel listener and talker.
130 STOP
140 END

```

Sample result: Tr(0) = 6312 Tr(1) = 6319 .... Tr(999) = 6208 Tr(1000) = 6211



Example PC-16: Input data to memory A in ASCII format.

```

10 ISET IFC:ISET REN          ' Execute interface clear and remote enable.
20 A=0:ST=3.14/100
30 PRINT @8;"AB TAA"         ' Specify ASCII input to memory A.
40 FOR I=0 TO 1000
50   N=INT(SIN(A)*5000)+5000
60   A=A+ST
70   PRINT @8;N
80 NEXT I
90 PRINT @8;"AV"             ' A VIEW
100 STOP
110 END

```

Example PC-17: Input data to memory A in binary format.

```

10 ISET IFC:ISET REN          ' Execute interface clear and remote enable.
20 DIM DT(1001)
30 A=0:ST=3.14/100
40 PRINT @8;"AB CWA TBA"     ' Specify binary input to memory A.
50 FOR I=0 TO 1000
60   DT(I)=INT(COS(A)*5000)+5000
70   A=A+ST
80 NEXT I
90                             ' Cancel listener and address PC9801 to #30 as
100                            ' talker and this device to #8 as listener.
110 WBYTE &H3F,&H5F,&H5E,&H28;DT(0)¥256,DT%(0) MOD 256
120 FOR I=1 TO 999
130  WBYTE ; DT(I)¥256,DT(I) MOD 256 ' Transfer data, first high-order bytes and then
140 NEXT I                     ' low-order bytes.
150 WBYTE ; DT(1000)¥256,DT(1000) MOD 256@ 'When the last data is input, send EOI signal.
160 PRINT @8;"AV"             ' A VIEW
170 STOP
180 END

```

## 6. Sample programs

Sample programs for HP200, HP300 series (GPIB address = 1)

Example HP-12: Output data from memory A in ASCII format.

```

10 DIM Tr(1000)           ! Reserve 1001 variables.
20 OUTPUT 701;"DL3"      ! Set delimiter to CR LF.
30 OUTPUT 701;"TAA?"     ! Specify ASCII output from memory A.
40 FOR I=0 TO 1000       ! Repeat data fetching 1001 times.
50 ENTER 701;Tr(I)       !
60 NEXT I                !
70 END

```

Sample result: Tr(0) = 5208 Tr(1) = 5210 .... Tr(999) = 5311 Tr(1000) = 5298

Example HP-13: Output data from memory B in binary format.

```

10 DIM Tr(1000)           ! Reserve 1001 variables.
20 OUTPUT 701;"DL2"      ! Set delimiter to EOI.
30 OUTPUT 701;"TBB?"     ! Specify binary output from memory B.
40 ENTER 701 USING "%,W";Tr(*) ! Repeat word type conversion and data fetching till
50 END                   ! EOI is encountered.

```

Sample result: Tr(0) = 6312 Tr(1) = 6319 .... Tr(999) = 6208 Tr(1000) = 6211

**Note**

*For ASCII data, be sure to set the number of I/O operations to 1001. For binary data, reserve data for 1001 points, and set EOI for delimiter.*

Example HP-14: Input data to memory A in ASCII format.

```

10 INTEGER Tr(1000)           |
20 OUTPUT 701;"TAA"          | Specify ASCII input to memory A.
30 FOR I=0 TO 1000           | Repeat inputting variable Tr (1001 variables reserved)
40 OUTPUT 701;Tr(I)          | 1001 times.
50 NEXT I                     |
60 END

```

**Note**

*It is necessary to set to VIEW mode before executing the program. After the program has been executed, pressing VIEW key again enables to check the result of input.*

Example HP-15: Input data to memory B in binary format.

```

10 INTEGER Tr(1000)           |
20 OUTPUT 701;"TBB"          | Specify binary input to memory B.
30 OUTPUT 701 USING "#,W";Tr(*),END | Input 1001 pieces of word size data and attach
40 END                        | EOI following the last data.

```

**Note**

*It is necessary to set to VIEW mode before executing the program. After the program has been executed, pressing VIEW key again enables to check the result of input.*

**Note**

*For ASCII data, be sure to set the number of I/O operations to 1001.  
For binary data, reserve data for 1001 points, and set EOI for delimiter.*

## 6. Sample programs

## ● Example of the program with using the status byte

Sample programs for PC9801 series (GPIB address = 8)

Example PC-18: Execute single sweeping and wait the end of the sweeping (In the case of not using SRQ signal)

```

10 ISET IFC:ISET REN      ' Send IFC signal and set REN signal in 1.
20 SPA = 8                ' Set GP-IB address (8) in a variable.
30 PRINT @SPA;"S1"        ' Set in the single sweeping mode.
40 PRINT @SPA;"OPR8"      ' Make Sweep-end bit of operation status
50                        ' register enable.
60 PRINT @SPA;"*CLS"      ' Clear the status byte.
70 PRINT @SPA;"TS"        ' Begin the sweeping.
80 *LOOP                  '
90 PRINT @SPA;"*STB?" : INPUT @SPA;S ' Read the status byte.
100 IF (S AND 128) = 0 THEN GOTO *LOOP ' Wait until the operation status bit (end of
110                        ' sweeping) is set in one.
120 STOP

```

Example PC-19: Execute CW-ACP measurement and begin the reading of the result after the measurement is ended.

```

10 ISET IFC:ISET REN      ' Send IFC signal and set REN signal in 1.
20 SPA = 8                ' Set GP-IB address (8) in a variable.
30 PRINT @SPA;"ACPST MNL" ' Set the condition of ACP measurement in 'Manual'.
40 PRINT @SPA;"CF1500MZ"  ' Set the center frequency in 1500MHz.
50 PRINT @SPA;"SP250KZ"   ' Set the frequency span in 250kHz.
60 PRINT @SPA;"RB1KZ; VB3KZ" ' Set RBW in 1kHz and VBW in 3kHz.
70 PRINT @SPA;"ST20SC"    ' Set the sweeping time in 20 seconds.
80 PRINT @SPA;"ADCH50KZ"  ' Set the channel space in 50kHz.
90 PRINT @SPA;"ADBS21KZ"  ' Set the band width in 21kHz.
100 PRINT @SPA;"OPR16"    ' Make the Measuring bit of the operation
110                        ' status register enable.
120 PRINT @SPA;"*CLS"     ' Clear the status byte.
130 PRINT @SPA;"ACP"      ' Begin ACP measurement.
140 *LOOP                  '
150 PRINT @SPA;"*STB?" : INPUT @SPA;S ' Read the status byte.
160 IF (S AND 128) = 0 THEN GOTO *LOOP ' Wait the end of ACP measurement.
170 PRINT @SPA;"ACP?"     ' Demand the output of the result of ACP measurement.
180 INPUT @SPA;LO,UP      ' Read the result of ACP measurement.
190 PRINT "-50K:";LO;" ,-50K:";UP' Display the result of the Measurement.
200 STOP

```

Example PC-20: Read the peak frequency and the level on every end of single sweeping. (In the case of using SRQ signal.)

10 ISET IFC:ISET REN	' Send IFC signal and set REN signal in 1.
20 SPA = 8	' Set GP-IB address (8) in a variable.
30 PRINT @SPA;"SI"	' Set in single sweeping mode.
40 ON SRQ GOSUB *SSRQ	' Define the SRQ interrupt processing routine.
50 PRINT @SPA;"*CLS"	' Clear the status byte.
60 PRINT @SPA;"OPR8"	' Make the Sweep-end bit of the operation status register enable.
70 PRINT @SPA;"*SRE128"	' Make the Operation Status bit of the status byte enable.
80 PRINT @SPA;"S0"	' Specify the sending out mode of SRQ signal.
90 *LOOP	
100 SEND = 0	' Clear the Sweep-end flag.
110 PRINT @SPA;"TS"	' Begin the sweeping.
120 SRQ ON	' Make the SRQ interruption of PC enable.
130 *WINT	
140 IF SEND = 0 THEN GOTO *WINT	' Wait until SRQ interruption occurs.
150 PRINT @SPA;"PS"	' Execute the peak search.
160 PRINT @SPA;"MFL?"	' Demand the output of the marker data.
170 INPUT @SPA;MF,ML	' Read the peak frequency and the level.
180 PRINT "Peak Freq:";MF;" ,Peak Level:";ML	' Display the read data.
190 GOTO *LOOP	' Repeat the sweeping.
200	
210 *SSRQ	' SRQ interrupt processing routine.
220 POLL SPA,S	' Read the status byte.
230 SEND = 1	' Set the Sweep-end flag in 1.
240 RETURN	' Return to the main routine.
250	
260 END	

## 6. Sample programs

Sample programs for HP200, HP300 series (GPIB address = 1)

Example HP-16: Execute the sweeping and wait the end of the sweeping. (In the case of not using SRQ signal.)

```

10 Spa = 708                ! Set GP-IB address (8) in a variable.
20 OUTPUT Spa;"SI"         ! set in the single sweeping mode.
30 OUTPUT Spa;"OPR8"      ! Make the Sweep-end bit of the operation status
40                          ! register enable.
50 OUTPUT Spa;"*CLS"      ! Clear the status byte.
60 OUTPUT Spa;"TS"        ! Begin the sweeping.
70 Mloop: !
80 OUTPUT Spa;"*STB?"     ! Demand the output of the status byte.
90 ENTER Spa;S            ! Read the status byte.
100 IF BIT(S,7) = 0 THEN GOTO Mloop ! Wait until the operation status bit (end of
110                          ! sweeping) is set in 1.
120 STOP
130 END

```

Example HP-17: Execute CW-ACP measurement and read out the result after the end of the measurement. (In the case of not using SRQ signal.)

```

10 Spa = 708                ! Set GP-IB address (8) in a variable.
20 OUTPUT Spa;"ACPST MNL" ! Set the condition of ACP measurement in 'Manual'.
30 OUTPUT Spa;"CF1500MZ"  ! Set the center frequency in 1500MHz.
40 OUTPUT Spa;"SP250KZ"   ! Set the frequency span in 250kHz.
50 OUTPUT Spa;"RB1KZ; VB3KZ" ! Set RBW in 1kHz and VBW in 3kHz.
60 OUTPUT Spa;"ST20SC"    ! Set the sweeping time in 20 seconds.
70 OUTPUT Spa;"ADCH50KZ"  ! Set the channel space in 50kHz.
80 OUTPUT Spa;"ADBS21KZ"  ! Set the band width in 21kHz.
90 OUTPUT Spa;"OPR16"     ! Make the Measuring bit of the operation status
100                          ! register enable.
110 OUTPUT Spa;"*CLS"     ! Clear the status byte.
120 OUTPUT Spa;"ACP"      ! Begin ACP measurement.
130 Mloop: !
140 OUTPUT Spa;"*STB?"    ! Demand the output of the status byte.
150 ENTER Spa;S           ! Read the status byte.
160 IF BIT(S,7) = 0 THEN GOTO Mloop ! Wait the end of ACP measurement.
170 OUTPUT Spa;"ACP?"     ! Demand the output of the result of ACP measurement.
180 ENTER Spa;Lo,Up       ! Read the result of ACP measurement.
190 PRINT "-50K:";Lo;" , +50K:";Up ! Display the result of the Measurement.
200 END

```

Example HP-18: Read to peak frequency and the level on every end of the single sweeping. (In the case of using SRQ signal.)

```

10 Spa = 708                ! Set GP-IB address (8) in a variable.
20 OUTPUT Spa;"SI"         ! Set in single sweeping mode.
30 ON INTR 7 GOSUB Ssrq    ! Define the SRQ interrupt processing routine.
40 OUTPUT Spa;"*CLS"       ! Clear the status byte.
50 OUTPUT Spa;"OPR8"      ! Make the Sweep-end bit of the operation status
60                          ! register enable.
70 OUTPUT Spa;"*SRE128"   ! Make the Operation Status bit of the status byte
80                          ! enable.
90 OUTPUT Spa;"S0"        ! Specify the sending out mode of SRQ signal.
100 Mloop: !
110 Mend = 0               ! Clear the Sweep-end flag.
120 OUTPUT Spa;"TS"       ! Begin the sweeping.
130 ENABLE INTR 7;2       ! Make the SRQ interruption enable.
140 Wint: !
150 IF Mend = 0 THEN GOTO Wint ! Wait until SRQ interruption occurs.
160 OUTPUT Spa;"PS"       ! Execute the peak search.
170 OUTPUT Spa;"MFL?"     ! Demand the output of the marker data.
180 ENTER Spa;MF,ML       ! Read the peak frequency and the level.
190 PRINT "Peak Freq:";MF;" ,Peak Level:";ML ! Display the read data.
200 GOTO Mloop            ! Repeat the sweeping.
210 !
220 Ssrq:                 ! SRQ interrupt processing routine.
230 S = SPOLL(Spa)        ! Read the status byte.
240 Mend = 1              ! Set the Sweep-end flag in 1.
250 RETURN                ! Return to the main routine.
260 !
270 END

```

## 6. Sample programs

## ● Program example of transient mode

Program example of PC9801 series (GP-IB Address = 8)

Example PC-21 Measure PHS power, ACP, and Modulation Accuracy with Transient mode. (When SRQ signal is used.)

```

10 ISET IFC :ISET REN          ' Transmit IFC signal and set REN signal to 1.
20 SPA = 8                    ' Set GP-IB address (8) for variable.
30 PRINT @SPA;"CF1895. 15MZ"   ' Set Center Frequency to 1895.15MHz.
40 GOSUB *COMMON. SETUP      ' Set STD.
50 ON SRQ GOSUB *SSRQ        ' Define the SRQ interrupt-service routine.
60 PRINT @SPA;"*CLS"          ' Clear Status byte.
70 PRINT @SPA;"*OPR16"        ' Enable Measuring-end bit of Operation
                               Status Register.
80 PRINT @SPA;"*SRE128"       ' Enable the Operation Status bit of the status
                               byte.
90 PRINT @SPA;"S0"            ' Set the SRQ output mode.
100 GOSUB *AUTO. LEVEL        ' Set REF LEVEL to a suitable value.
110 GOSUB *MEAS. POWER        ' Measure power.
120 GOSUB *MEAS. ACP          ' Measure ACP.
130 GOSUB *MEAS. MODACC       ' Measure Modulation Accuracy.
140 STOP
150 '
160 *COMMON. SETUP            ' Setup routine of STD conditions.
170 PRINT @SPA;"SETFUNC TRAN" ' Select Transient mode.
180 PRINT @SPA;"MODTYP PHS"   ' Set Communication System to "PHS".
190 PRINT @SPA;"LINK DOWN"    ' Set Communication Direction to Down-Link.
200 PRINT @SPA;"UNIQ NO"      ' Select the mode using no unique word.
210 PRINT @SPA;"MEASMD BURST" ' Select Burst mode.
220 PRINT @SPA;"NBURST B1"    ' Select 1-Burst.
230 PRINT @SPA;"RNYQ ON"      ' Set Root Nyquist Filter to ON.
240 RETURN
250 '
260 *MEAS. POWER              ' Power Measurement Routine.
270 PRINT @SPA;"TXPWR"        ' Start Antenna Power measurement.
280 GOSUB *WAIT. MEND         ' Wait for the end of measurement.
290 PRINT @SPA;"TXPWR?"       ' Demand the output of Antenna Power
                               measured result.
300 INPUT @SPA;AP. DB, AP. W, FP. DB, FP. W ' Read Antenna Power and Frame Power.
310 PRINT "Antenna Power [dBm] : " ;AP. DB ' Display Antenna Power.
320 RETURN

```



(ctd. from example PC-21)

```

330 '
340 *MEAS. ACP                ' ACP measurement routine.
350 PRINT @SPA;"TACP"        ' Start ACP measurement.
360 GOSUB *WAIT. MEND        ' Wait for the end of measurement.
370 PRINT @SPA;"TACP?"      ' Demand the output of ACP measured
                             results.

380 INPUT @SPA;BPWR, PL1, PL2, PU1, PU2, ML1, ML2, MU1, MU2
                             ' Read ACP measured results.

390 PRINT "-600K:";PL1;" , + 600K:";PU1;" , -900K:";PL2;" , + 900K:";PU2
400 RETURN
410 '
420 *MEAS. MODACC            ' Modulation Accuracy measurement routine.
430 PRINT @SPA;"MODACC"     ' Start Modulation Accuracy measurement.
440 GOSUB *WAIT. MEND        ' Wait for the end of measurement.
450 PRINT @SPA;"MODACC?"    ' Demand the output of Modulation Accuracy
                             measured results.

460 INPUT @SPA;BAD, F. ERR, IQ. OFF, M. ERR, P. ERR, EVM
                             ' Read Modulation Accuracy data.

470 PRINT "Amp Droop:";BAD;" , Freq Error:" ;F. ERR;" , IQ Offset:" ;IQ. OFF;
480 PRINT "Mag Error:";M. ERR;" , Phase Error:" ;P. ERR;" , Error Vector:" ;EVM
490 RETURN
500 '
510 *AUTO. LEVEL
520 PRINT @SPA;"AUTOLVL"    ' Set REF LEVEL to a suitable value to
                             measurement signal.

530 GOSUB *WAIT. MEND        ' Wait for the end of Auto Level processing.
540 RETURN
550 '
560 *WAIT. MEND
570 SEND = 0
580 SRQ ON                  ' Enable the SRQ interrupt of PC.
590 *WAIT.LOOP
600 IF SEND = 0 THEN GOTO *WAIT.LOOP
610 PRINT @SPA;"ERRNO?:INPUT @SPA;ERR.NUM
                             ' Reads an error number.

620 IF ERR.NUM < > 0 THEN GOTO *MEAS.ERROR
                             ' Executes *MEAS. ERROR if the error
                             number is not 0.

630 RETURN

```

6. Sample programs

(ctd. from example PC-21)

```
640 '  
650 *SSRQ  
660 POLL SPA,S  
670 SEND = 1  
680 RETURN  
690 '  
700 *MEAS. ERROR  
710 PRINT "Measuring Error. Error Number: ";ERR. NUM  
                                     ' Displays the error number.  
720 STOP  
730 '  
740 END
```

Program examples of HP200, 300 series (GP-IB Address = 8)

Example HP-19 Measure PHS power, ACP, and Modulation Accuracy with Transient mode. (When SRQ signal is used.)

```

10 Spa = 708                ! Set GP-IB address (8) for variable.
20 ON INTR 7 GOSUB Ssrq     ! Define SRQ interrupt processing routine.
30 OUTPUT Spa;"CF1895. 15MZ" ! Set Center Frequency to 1895.15MHz.
40 GOSUB Common_setup     ! Set STD.
50 OUTPUT Spa;"*CLS"       ! Clear Status bite.
60 OUTPUT Spa;"ORR16"     ! Enable Measuring-end bit of Operation
70                          ! Status Register.
80 OUTPUT Spa;"*SRE128"   ! Enable Operation Status bit of Status Bite.
90 !
100 OUTPUT Spa;"S0"       ! Specify SRQ signal transmission mode.
110 GOSUB Auto_level      ! Set REF LEVEL to a suitable value.
120 GOSUB Meas_power      ! Measure power.
130 GOSUB Meas_acp        ! Measure ACP.
140 GOSUB Meas_modacc     ! Measure Modulation Accuracy.
150 STOP
160 !
170 Common_setup:         ! Setup routine of STD conditions.
180 OUTPUT Spa;"SETFUNC TRAN" ! Select Transient mode.
190 OUTPUT Spa;"MODTYP PHS" ! Set Communication System to "PHS".
200 OUTPUT Spa;"LINK DOWN" ! Set Communication Direction to Down-Link.
210 OUTPUT Spa;"UNIQ NO"   ! Select the mode using no unique word.
220 OUTPUT Spa;"MEASMD BURST" ! Select Burst mode.
230 OUTPUT Spa;"NBURST B1" ! Select 1-Burst.
240 OUTPUT Spa;"RNYQ ON"  ! Set Root Nyquist Filter to ON.
250 RERTURN
260 !
270 Meas_power:          ! Power Measurement Routine.
280 OUTPUT Spa;"TXPWR"    ! Start Antenna Power measurement.
290 GOSUB Wait_mend      ! Wait for the end of measurement.
300 OUTPUT Spa;"TXPWR?"  ! Demand the output of Antenna Power
                          ! measured result.
310 ENTER Spa;Apdb, Apw, Fqdb, Fpw ! Read Antenna Power and Frame Power.
320 PRINT "Antenna Power [dBm]:" ;Apdb ! Display Antenna Power.
330 RETURN
340 !

```

## 6. Sample programs

(ctd. from example HP-19)

```

350 Meas_acp;           ! ACP measurement routine.
360 OUTPUT Spa;"TACP"  ! Start ACP measurement.
370 GOSUB Wait_mend    ! Wait for the end of measurement.
380 OUTPUT Spa;"TACP?" ! Demand the output of ACP measured
                        results.
390 ENTER Spa;Bpwr, PI1, PI2, Pu1, Pu2, MI1, MI2, Mu1, Mu2
                        ! Read ACP measured results.
400 PRINT "-600K:";PI1;" , + 600K:";Pu1;" , -900K:";PI2;" , + 900K";Pu2
410 RETURN
420 !
430 Meas_modacc:       ! Modulation Accuracy measurement routine.
440 OUTPUT Spa;"MODACC" ! Start Modulation Accuracy measurement.
450 GOSUB Wait_mend    ! Wait for the end of measurement.
460 OUTPUT Spa;"MODACC?" ! Demand the output of Modulation Accuracy
                        measured results.
470 ENTER Spa;Bad, Ferr, Iqoff, Merr, Perr, Evm ! Read Modulation Accuracy data.
480 PRINT "Amp Droop:" ;Bad;" , Freq Error:" ;Ferr;" , IQ Offset:" ;Iqoff;
490 PRINT "Mag Error:";Merr;" , Phase Error:" ;Perr;" , Error Vector:" ;Evm
500 RETURN
510 !
520 Auto_level: !
530 OUTPUT Spa;"AUTOLVL" ! Set REF LEVEL to a suitable value to
540 ! measurement signal.
550 GOSUB Wait_mend    ! Wait for the end of Auto Level processing.
560 RETURN
570 !
580 Wait_mend: !
590 Mend = 0           ! Clear Measurement End Flag.
600 ENABLE INTR 7;2    ! Enable SRQ interrupt.
610 Wloop: !
620 IF Mend = 0 THEN GOTO Wloop ! Wait for the generation of SRQ interrupt.
630 OUTPUT Spa;"ERRNO?" ! Reads the error number.
640 ENTER Spa;Err_num
650 IF Err_num < > 0 THEN GOTO Err_chk ! Executes Err_chk if the error number is not
                                0.
660 RETURN
670 !
680 Ssrq:             ! SRQ Interruption routine.
690 S = SPOLL(Spa)    ! Reads the status byte.
700 Mend = 1         ! Sets Measurement End Flag to 1.
710 RETURN
720 !

```

(ctd. from example HP-19)

```
730 Err_chk: !  
740 PRINT "Measuring Error. Error Number: ";Err_num    ! Displays the error number.  
750 STOP  
760 !  
770 END
```

## 7. RS-232 Remote Control Function

The controller ( such as personal computer and other) does not have GPIB interface, almost controllers have RS-232C interface, therefore, Spectrum Analyzer can be controlled using by it.

### ■ Compatibility of GPIB remote control and RS-232C remote control

Available control codes to use in the serial control is the same control codes except that the specific codes and the functions to the GPIB and some commands.

### ■ Setup for the measurement conditions

The following functions can be controlled for serial control.

- Setup for the measurement conditions :  
Each measurement conditions can be input in much the same as the key operation on the front panel.
- Output of the setup status:  
Each setup status and the data of the Spectrum Analyzer can be read out.
- Status output:  
Status bytes which is shown the current status of the Spectrum Analyzer can be read out as read out by GPIB.

## ■ Activation of the remote control

Press the key of LCL and RS232 then the setup menu of serial port is displayed.

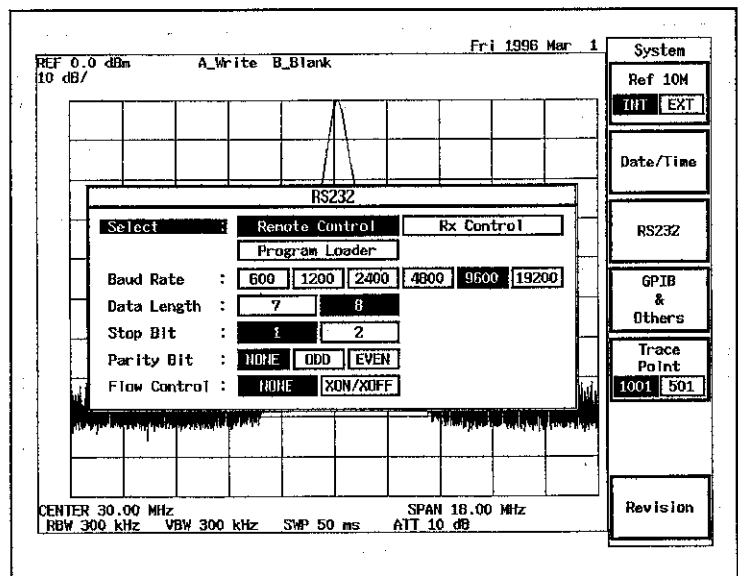

Figure 8-2 Selected window of serial port (OPT08 and OPT15 are already installed)

Select Remote Control on the selection window for activation of the remote control.

### Note

*If OPT08 is installed then Rx Control is displayed and can be selected.*

*If OPT15 is installed then Program Loader is displayed and can be selected.*

*\*: OPT08 is an option only for R3465 and R3463.*

## Parameter setup window

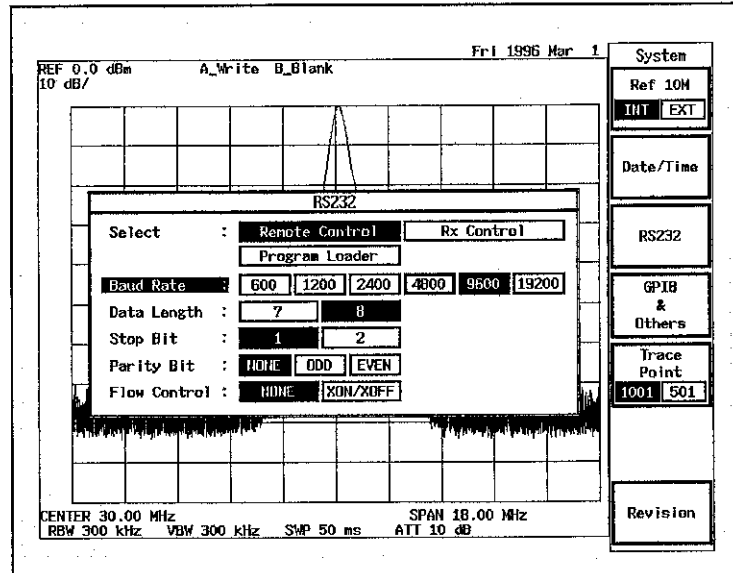

Figure 8-3 Parameter setup

- Transmission speed : Select the transmission speed in (600), (1200), (2400), (4800), (9600) and (19200).
- Data length : Select seven bits or eight bits of the number of data bit.
- Stop bit : Select one bit or two bits of stop bit.
- Parity check : Select from (NONE), (ODD) or (EVEN).
- Flow control : Select using by XON/XOFF or not.

### Note

*If parameters of the serial port are changed by the control command of OPT15 then changed values are inherited. Moreover, if Rx test mode is specified by OPT08 then specific parameter is set. Ensure the value of parameters again before execution of the remote control.*

\* : OPT08 is an option only for R3465 and R3463.



■ Interface connection

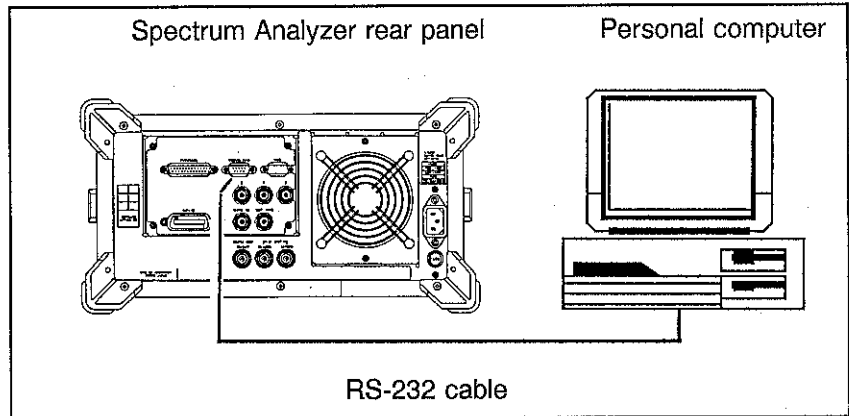

Figure 8-4 Connection of the controller and Spectrum Analyzer

The numbers of connection wires of the Spectrum Analyzer side are three wires and the controller side needs more connections for input and output interface.

**Note**

*Line control is different compared with the terminal emulation.*

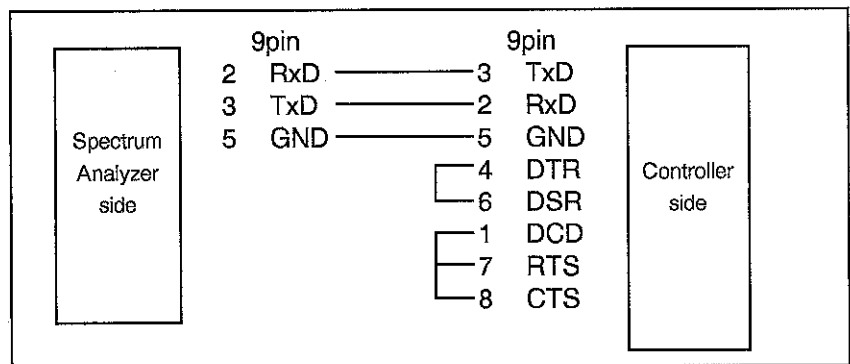

Figure 8-5 Cable wiring diagram

Pin No.(9pin)	Signal name	Contents
1	DCD:Data Carrier Detector	Receive carrier detection
2	RxD:Receive Data	Receive data
3	TxD:Transmit Data	Transmission data
4	DTR:Data Terminal Ready	Data terminal ready
5	GND:Ground	Signal ground
6	DSR:Data set Ready	Data set ready
7	RTS:Request To Send	Request signal for sending
8	CTS:Clear To Send	Clear signal for sending
9	Cl:	N.C



## ■ Different points between RS-232C and GPIB

- **Command code**
- Input and output of the trace data cannot be carried out.  
Moreover, delimited data with delimiter and these plural data is not available to read.

### **Note**

**Not available commands : TAA, TBA, TAB, TBB**

- SRQ interrupt cannot be used.  
Use read out command of the status bytes.

### **Note**

**Not available commands : S0, S1, S2, RQS**

## ■ Panel control

Spectrum analyzer becomes following status while the remote control is carried out.

- Remote lamp dose not light.
- Key lock is not carried out. If setup is changed by the key operation during remote control then remote control becomes instability occasionally.

## ■ Example of the remote control

In this examples are using by the function of the remote control in the actual program.

Described program examples in this subchapter are written in the "Microsoft Quick Basic" licensed by Microsoft Corporation. The Spectrum Analyzer does not have a capability of the serial line control for RS-232C, therefore, if the input statement (PRINT statement) are continuously written then the correct operation is not carried out occasionally such as input operation carried out until the end of program or wait for input (INPUT statement).

Do not exceed 1024 characters for the total number of input statement. (Refer to the input of the limit line.)

The open command of OPEN "COM1:9600, N, 8,1, ASC" FOR RANDOM AS #1 in the example program is the following contents.

Baud rate is 9600bps, no parity, 8 bits data length, stop bit of one bit, ASCII format and random access mode.

### Example 1 : Read out for peak list

```
OPEN "COM1:9600,N,8,1,ASC" FOR RANDOM AS #1
PRINT #1, "DL3"      ' CR and LF are set for GPIB delimiter
PRINT #1, "CF 30MZ"  ' Center frequency of 30MHz is set
PRINT #1, "PLS LEVEL" ' Level is specified for the peak list
PRINT #1, "TS"       ' Execution of the single sweep
PRINT #1, "PKLIST?"  ' Read out of the peak list
INPUT #1, C, F1, L1, F2, L2, F3, L3, F4, L4, F5, L5, F6, L6, F7, L7,
F8, L8, F9, L9, F10, L10, Delf, Dell
PRINT C, F1, L1, F2, L2, F3, L3, F4, L4, F5, L5, F6, L6, F7, L7, F8,
L8, F9, L9, F10, L10, Delf, Dell
END
```

### Example 2 : Waiting for the sweep completion by status bytes

```
OPEN "COM1:9600,N,8,1,ASC" FOR RANDOM AS #1
PRINT #1, "DL3"      ' CR and LF are set for GPIB delimiter
PRINT #1, "SI"       ' Execution of the single sweep
PRINT #1, "OPR8"     ' Sweep completion bit in the operation register of GPIB is set
PRINT #1, "CLS"      ' Clear for status bytes
PRINT #1, "TS"       ' Execution of the single sweep
MEAS.LOOP
PRINT #1, "*STB?"    ' Read our status bytes
INPUT #1, STAT
IF (STAT AND 128) = 0 THEN GOTO MEAS.LOOP
PRINT #1, "PS"       ' Peak search
PRINT #1, "ML?"     ' Read out peak level
INPUT #1, MLEVEL
PRINT MLEVEL
END
```

## ■ Error message

Following are error messages for the remote control.

- input buffer is overflow
- SIO port is busy

### ● input buffer is overflow

If total input characters exceeds 1024 characters then this is displayed.

(1 of 2)

Example 1 : Input of limit line

```
OPEN "COM1:9600,N,8,1,ASC" FOR RANDOM AS #1
PRINT #1, "IP"
PRINT #1, "DL3"
PRINT #1, "LMTADEL"
PRINT #1, "UU"

PRINT #1, "LMTAIN 500.123KZ, 70.52DB"
PRINT #1, "LMTAIN 5.432112MZ, 70.52DB"
PRINT #1, "LMTAIN 5.432112MZ, 55.57DB"
PRINT #1, "LMTAIN 10.012345MZ, 55.57DB"
PRINT #1, "LMTAIN 10.012345MZ, 43.25DB"
PRINT #1, "LMTAIN 15.012345MZ, 43.25DB"
PRINT #1, "LMTAIN 15.012345MZ, 30.25DB"
PRINT #1, "LMTAIN 20.987654MZ, 30.25DB"
PRINT #1, "LMTAIN 20.987654MZ, 51.51DB"
PRINT #1, "LMTAIN 25.123456MZ, 51.51DB"
PRINT #1, "LMTAIN 25.123456MZ, 20.38DB"
PRINT #1, "LMTAIN 30.123456MZ, 20.38DB"
PRINT #1, "LMTAIN 30.123456MZ, 32.38DB"
PRINT #1, "LMTAIN 35.456789MZ, 32.38DB"
PRINT #1, "LMTAIN 35.456789MZ, 35.55DB"
PRINT #1, "LMTAIN 40.345678MZ, 35.55DB"
PRINT #1, "LMTAIN 40.345678MZ, 40.62DB"
PRINT #1, "LMTAIN 45.345678MZ, 40.62DB"
PRINT #1, "LMTAIN 45.345678MZ, 45.62DB"
PRINT #1, "LMTAIN 50.345678MZ, 45.62DB"
PRINT #1, "LMTAIN 50.345678MZ, 51.62DB"
PRINT #1, "LMTAIN 55.654321MZ, 51.62DB"
PRINT #1, "LMTAIN 55.654321MZ, 54.35DB"
PRINT #1, "LMTAIN 65.345678MZ, 54.35DB"
PRINT #1, "LMTAIN 65.345678MZ, 57.08DB"
PRINT #1, "LMTAIN 70.987654MZ, 57.08DB"
PRINT #1, "LMTAIN 70.987654MZ, 60.52DB"
PRINT #1, "LMTAIN 75.765432MZ, 60.52DB"
PRINT #1, "LMTAIN 75.765432MZ, 62.31DB"
PRINT #1, "LMTAIN 80.123456MZ, 62.31DB"
```

(2 of 2)

```
PRINT #1, "LMTAIN 80.123456MZ, 63.54DB"  
PRINT #1, "LMTAIN 85.234567MZ, 63.54DB"  
PRINT #1, "LMTAIN 85.234567MZ, 68.45DB"  
PRINT #1, "LMTAIN 90.765432MZ, 68.45DB"  
PRINT #1, "LMTAIN 90.765432MZ, 70.05DB"  
PRINT #1, "LMTAIN 95.456789MZ, 70.05DB" ' Inputs are carried out until this line and  
PRINT #1, "LMTAIN 95.456789MZ, 81.29DB" ' exceeds 1024 characters in the line  
PRINT #1, "LMTAIN 100MZ, 81.29DB"  
'  
PRINT #1, "FA0MZ FB100MZ"  
PRINT #1, "LAN"  
END
```

If the dummy INPUT statements are inserted such as following example then all of above mentioned command can be input.

(1 of 2)

Example 2 : Input of limit line

```
OPEN "COM1:9600,N,8,1,ASC" FOR RANDOM AS #1  
PRINT #1, "IP"  
PRINT #1, "DL3"  
PRINT #1, "LMTADEL"  
PRINT #1, "UU"  
'  
PRINT #1, "LMTAIN 500.123KZ, 70.52DB"  
PRINT #1, "LMTAIN 5.432112MZ, 70.52DB"  
PRINT #1, "LMTAIN 5.432112MZ, 55.57DB"  
PRINT #1, "LMTAIN 10.012345MZ, 55.57DB"  
PRINT #1, "LMTAIN 10.012345MZ, 43.25DB"  
PRINT #1, "LMTAIN 15.012345MZ, 43.25DB"  
PRINT #1, "LMTAIN 15.012345MZ, 30.25DB"  
PRINT #1, "LMTAIN 20.987654MZ, 30.25DB"  
PRINT #1, "LMTAIN 20.987654MZ, 51.51DB"  
PRINT #1, "LMTAIN 25.123456MZ, 51.51DB"  
'  
PRINT #1, "LIMTYP?" 'Dummy query command  
INPUT #1, A$ 'Dummy INPUT statement  
'  
PRINT #1, "LMTAIN 25.123456MZ, 20.38DB"  
PRINT #1, "LMTAIN 30.123456MZ, 20.38DB"  
PRINT #1, "LMTAIN 30.123456MZ, 32.38DB"  
PRINT #1, "LMTAIN 35.456789MZ, 32.38DB"  
PRINT #1, "LMTAIN 35.456789MZ, 35.55DB"  
PRINT #1, "LMTAIN 40.345678MZ, 35.55DB"  
PRINT #1, "LMTAIN 40.345678MZ, 40.62DB"  
PRINT #1, "LMTAIN 45.345678MZ, 40.62DB"
```

(2 of 2)

```
PRINT #1, "LMTAIN 45.345678MZ, 45.62DB"  
PRINT #1, "LMTAIN 50.345678MZ, 45.62DB"  
,  
PRINT #1, "LIMTYP?"                'Dummy query command  
INPUT #1, A$                       'Dummy INPUT statement  
,  
PRINT #1, "LMTAIN 50.345678MZ, 51.62DB"  
PRINT #1, "LMTAIN 55.654321MZ, 51.62DB"  
PRINT #1, "LMTAIN 55.654321MZ, 54.35DB"  
PRINT #1, "LMTAIN 65.345678MZ, 54.35DB"  
PRINT #1, "LMTAIN 65.345678MZ, 57.08DB"  
PRINT #1, "LMTAIN 70.987654MZ, 57.08DB"  
PRINT #1, "LMTAIN 70.987654MZ, 60.52DB"  
PRINT #1, "LMTAIN 75.765432MZ, 60.52DB"  
PRINT #1, "LMTAIN 75.765432MZ, 62.31DB"  
PRINT #1, "LMTAIN 80.123456MZ, 62.31DB"  
,  
PRINT #1, "LIMTYP?"                'Dummy query command  
INPUT #1, A$                       'Dummy INPUT statement  
,  
PRINT #1, "LMTAIN 80.123456MZ, 63.54DB"  
PRINT #1, "LMTAIN 85.234567MZ, 63.54DB"  
PRINT #1, "LMTAIN 85.234567MZ, 68.45DB"  
PRINT #1, "LMTAIN 90.765432MZ, 68.45DB"  
PRINT #1, "LMTAIN 90.765432MZ, 70.05DB"  
PRINT #1, "LMTAIN 95.456789MZ, 70.05DB"  
PRINT #1, "LMTAIN 95.456789MZ, 81.29DB"  
PRINT #1, "LMTAIN 100MZ, 81.29DB"  
,  
PRINT #1, "FA0MZ FB100MZ"  
PRINT #1, "LAN"  
END
```

● **SIO port is busy**

If the serial port is used for two or more functions then this message is displayed.

■ **Change for other options**

The remote control is not available for the parallel operation with the following options which uses the serial port.  
( refer to the activation of the remote control.)

- OPT08
- OUTPUT32 of OPT15 serial port.

**Note**

**OPT08 is an option only for R3465 and R3463.**

## 8. Batch Measurement Command for the TRANSIENT mode of the Transmission System

The measurement command of the conventional TRANSIENT mode is divided into the each measurement items. The new batch measurement command (TXMEAS) is developed.

The following measurement items of the transmission system can be carried out simultaneously using by this new command.

- Modulation accuracy
- Occupied band width
- Adjacent channel leakage power (Note)
- Transmission velocity
- Antenna power
- Carrier off leakage power

### Note

*When the batch measurement command is carried out, the adjacent channel leakage power (ACP) is always measured in the "FREQ" mode.*

*When specifying how many times the above items should be measured, use the conventional averaging commands.*

*This setting is not available for the ACP.*

*The table shown below lists the maximum number of times each item can be measured.*

*When the measurement number setting is more than the maximum allowed, the maximum is automatically set.*

**Unit : Number of measurements**

	<i>Modulation accuracy Occupied band width Antenna power</i>	<i>Transmission velocity</i>	<i>Carrier off leakage power</i>	<i>Adjacent channel leakage power</i>
<i>PHS</i>	<i>10</i>	<i>5</i>	<i>32</i>	<i>1</i>
<i>PDC/NADC (FULL RATE)</i>	<i>20</i>	<i>10</i>	<i>32</i>	<i>1</i>
<i>PDC/NADC (HALF RATE)</i>	<i>10</i>	<i>5</i>	<i>32</i>	<i>1</i>

Moreover, above mentioned each measurement items can be selected by the ON and OFF command. Selected batch measurement items by the ON and OFF command is erased by carrying out the IP or turn OFF the power. All of the above mentioned measurement items is selected by carrying out the IP or the initial state of turn on the power.

Read out the result of measurement data after execution of "TXMEAS" command can be carried out by query command.

● **Table of the batch measurement command for the transmission system**

	Function	Listener code	Talker request		Remarks
			Code	Output format	
Measurement start	Measurement command for transmission system	TXMEAS	-	-	



## 8. Batch measurement Command for the TRANSIENT mode of the Transmission System

(2 of 2)

Function	Listener code	Talker request		Remarks	
		Code	Output format		
Measurement conditions	Selection of the measurement (Mod Accuracy)				
	Modulation accuracy ON	MODACCST ON	MODACCST?	0 : OFF	
	OFF	MODACCST OFF		1 : ON	
	OBW ON	TOBWST ON	TOBWST?	0 : OFF	
	OFF	TOBWST OFF		1 : ON	
	ACP ON	TACPST ON	TACPST?	0 : OFF	
	OFF	TACPST OFF		1 : ON	
	(Transfer Rate)				
	Transmission velocity ON	BTRST ON	BTRST?	0 : OFF	
	OFF	BTRST OFF		1 : ON	
	(Antenna Power)				
	Antenna power ON	TXPWRST ON	TXPWRST?	0 : OFF	
	OFF	TXPWRST OFF		1 : ON	
	(Carrier OFF Power)				
Carrier OFF leakage power ON	OFFPWRST ON	OFFPWRST?	0 : OFF		
OFF	OFFPWRST OFF		1 : ON		
Setting the number of measurements performed					
Modulation accuracy	TAVGMOD *	TAVGMOD?	Integer		
Occupied band width	TAVGOBW *	TAVGOBW?	Integer		
Transmission velocity	TAVGTR *	TAVGTR?	Integer		
Antenna power	TAVGAP *	TAVGAP?	Integer		
Carrier off leakage power	TAVGCR *	TAVGCR?	Integer		
Measurement result	(Mod Accuracy)				
	Modulation accuracy	-	MODACC?	<BADroop, F-Err, IQ-off, Mag-err, Ph-err, EVM >	
	OBW	-	TOBW?	Frequency	
	ACP	-	TACP?	< bpwr, pl1, pl2, pu1, pu2 ml1, ml2, mu1, mu2 >	pl1 to pu2[dB] bpwr, ml1 to mu2 =0 (FREQ mode)
	(Bit Rate Error)				
	Transmission velocity	-	BITERR?	n1, n2 (% , Hz)	
	(Antenna Power)				
Antenna power	-	TXPWR?	< Ap1, Ap2, Fp1, Fp2 >		
(Carrier OFF Power)					
Carrier OFF leakage power	-	OFFPWR?	(dBm, mW, dBm, mW) p1, p2 (dBm, nw)		

## 8. Batch measurement Command for the TRANSIENT mode of the Transmission System

● Sample program of the batch measurement command for the transmission system

Sample programs for PC9801 series (GPIB address = 8)

(1 of 2)

Example PC-22: The following sample program is the measurement for the power, ACP and modulation accuracy of PHS in the TRANSIENT mode using.  
(When SRQ signal is used.)

10 ISET IFC:ISET REN	'	Transmit IFC signal and set REN signal to 1.
20 SPA = 8	'	Set GPIB address (8) to a variable.
30 PRINT @SPA;"CF1895.15MZ"	'	Set center frequency to 1895.5MHz.
40 GOSUB *COMMON.SETUP	'	Carry out STD setup and selection of measurement object.
50 ON SRQ GOSUB *SSRQ	'	Define SRQ interrupt routine.
60 PRINT @SPA;"*CLS"	'	Clear the status byte.
70 PRINT @SPA;"OPR16"	'	Enable the measuring End bit of the operation status register.
80 PRINT @SPA;"*SRE128"	'	Enable the operation Status bit of the status byte.
90 PRINT @SPA;"S0"	'	Enable SRQ.
100 GOSUB *AUTO.LEVEL	'	Setup an optimum value for the REF LEVEL.
110 GOSUB *MEAS.TXALL	'	Batch measurement for the transmission system.
120 GOSUB *MEAS.READ	'	Read out the result of batch measurement.
130 STOP		
140 '		
150 *COMMON.SETUP	'	Setup the STD conditions and the device under measurement.
160 PRINT @SPA;"SETFUNC TRAN"	'	Select Transient mode.
170 PRINT @SPA;"MODTYP PHS"	'	Setup for the communication system for PHS.
180 PRINT @SPA;"LINK DOWN"	'	Setup for the communication system for Down-link.
190 PRINT @SPA;"UNIQ NO"	'	Select the mode without a use of the unique words.
200 PRINT @SPA;"MEASMD BURST"	'	Select Burst mode.
210 PRINT @SPA;"NBURST B1"	'	Select 1-Burst.
220 PRINT @SPA;"RNYQ ON"	'	Setup ON status of the root nyquist filter.
230 PRINT @SPA;"BTRST OFF; OFFPWRST OFF; TOBWST OFF"		
240	'	Reject transmission velocity, OFF power and OBW
250	'	measurement from the batch measurement.
260 RETURN		
270 '		
280 *MEAS.TXALL	'	Batch measurement routine for the transmission system.
290 PRINT @SPA;"TXMEAS"	'	Start the batch measurement.
300 GOSUB *WAIT.MEND	'	Wait for the measurement end.
310 RETURN		
320 '		
330 *MEAS.READ	'	Read in the measurement result.
340 PRINT @SPA;"TACP?"	'	Request for the output of ACP measurement result.
350 INPUT @SPA;BPWR,PL1,PL2,PU1,PU2,ML1,ML2,MU1,MU2	'	Read in the ACP measurement result.

## 8. Batch measurement Command for the TRANSIENT mode of the Transmission System

(2 of 2)

```

360 PRINT "-600K:";PL1;" , + 600K:";PU1;" , -900K:";PL2;" , + 900K:";PU2
      ' Display for the result.
370 '
380 PRINT @SPA;"TXPWR?"      ' Request for the output of the Antenna Power
      ' measurement result.measurement result.
390 INPUT @SPA;AP.DB,AP.W,FP.DB,FP.W
      ' Read in the Antenna power measurement result.
400 PRINT @SPA;"Antenna Power[dBm]:";AP.DB
      ' Display for the result.
410 '
420 INPUT @SPA;"MODACC?"      ' Request for the output of the modulation accuracy
430 INPUT @SPA;BAD,F.ERR,IQ.OFF,M.ERR,P.ERR,EVM
      ' Read in the modulation accuracy data.
440 PRINT "Amp Droop:";BAD;" ,Freq Error:";F.ERR;" ,IQ Offset:";IQ.OFF;
      ' Display for the result.
450 PRINT "Mag Error:";M.ERR;" ,Phase Error:";P.ERR;" ,Error Vector:";EVM
460 RETURN
470 '
480 *AUTO.LEVEL
490 PRINT @SPA;"AUTOLVL"      ' Setup an optimum value for the REF LEVEL
      ' according to the measurement signal.
500 GOSUB *WAIT.MEND          ' Wait for the end of Auto Level process.
510 RETURN
520 '
530 *WAIT.MEND
540 SEND = 0
550 SRQ ON                    ' Enable SRQ interrupt of PC.
560 *WAIT.LOOP
570 IF SEND = 0 THEN GOTO *WAIT.LOOP
580 PRINT @SPA;"ERRNO?":INPUT @SPA;ERR.NUM
      ' Read the error number.
590 IF ERR.NUM < > 0 THEN GOTO :MEAS.ERROR
      ' The measurement error at the number other than
      ' zero.
600 RETURN
610 '
620 *SSRQ
630 POLL SPA,S
640 SEND = 1
650 RETURN
660 '
670 *MEAS.ERROR
680 PRINT "Measuring Error. Error Number:";ERR.NUM
      ' Display for the error number.
690 STOP
700 '
710 END

```

## 8. Batch measurement Command for the TRANSIENT mode of the Transmission System

Sample programs for HP200, 300 series (GPIB address = 8)

(1 of 2)

Example HP-20: The following sample program is the measurement for the power, ACP and modulation accuracy of PHS in the TRANSIENT mode using.  
(When SRQ signal is used.)

```

10 Spa = 708                | Set GPIB address (8) to a variable.
20 ON INTR 7 GOSUB Ssrq     | Define SRQ interrupt routine.
30 OUTPUT Spa;"CF 1895.15MZ" | Set center frequency to 1895.5 MHz.
40 GOSUB Common_setup      | Carry out STD setup.
50 OUTPUT Spa;"CLS"        | Clear status byte.
60 OUTPUT Spa;"OPR16"      | Enable the measuring End bit of the operation status
70                          | register.
80 OUTPUT Spa;"SRE128"     | Enable the Operation Status bit of the status byte.
90                          |
100 OUTPUT Spa;"S0"        | Enable SRQ.
110 GOSUB Auto_level       | Setup an optimum value for the REF LEVEL.
120 GOSUB Meas_txall       | Batch measurement for the transmission system.
130 GOSUB Meas_read        | Read out the result of batch measurement.
140 STOP
150 !
160 Common_setup:          | Setup the STD conditions and the device under
                          | measurement.
170 OUTPUT Spa;"SETFUNC TRAN" | Select Transient mode.
180 OUTPUT Spa;"MODTYP PHS"  | Setup for the communication system for PHS.
190 OUTPUT Spa;"LINK DOWN"  | Setup for the communication system for Down-link.
200 OUTPUT Spa;"UNIQ NO"    | Select the mode without a use of the unique words.
210 OUTPUT Spa;"MEASMD BURST" | Select Burst mode.
220 OUTPUT Spa;"NBURST B1"  | Select 1-Burst.
230 OUTPUT Spa;"RNYQ ON"    | Setup ON status of the root nyquist filter.
240 OUTPUT Spa;"BTRST OFF;OFFPWRST OFF;TOBWST OFF"
250                          | Reject transmission velocity, OFF power and OBW
260                          | measurement from the batch measurement.
270 RETURN
280 !
290 Meas_txall:            | Batch measurement routine for the transmission system.
300 OUTPUT Spa;"TXMEAS"     | Start the batch measurement.
310 GOSUB Wait_mend        | Wait for the measurement end.
320 RETURN
330 !
340 Meas_read:             | Read in the measurement result.
350 OUTPUT Spa;"TACP?"      | Request for the output of ACP measurement result.
360 ENTER Spa;Bpwr,PI1,PI2,Pu1,Pu2,MI1,MI2,Mu1,Mu2
                          | Read in the ACP measurement result.

```

## 8. Batch measurement Command for the TRANSIENT mode of the Transmission System

(2 of 2)

```

370 PRINT "-600K: ";PI1;" , + 600K: ";Pu1;" , -900K: ";PI2;" , + 900K: ";Pu2
      | Display for the result.
380 |
390 OUTPUT Spa;"MODACC?"      | Request for the output of the modulation accuracy
      | measurement result.
400 ENTER Spa;Bad,Ferr,lqoff,Merr,Perr,Evm
      | Read in the modulation accuracy data.
410 PRINT "Amp Droop: ";Bad;" ,Freq Error: ";Ferr" ,IQ Offset: ";lqoff;
      | Display for the result.
420 PRINT "Mag Error: ";Merr;" ,Phase Error: ";Perr;" ,Error Vector: ";Evm
425 RETURN
430 |
440 Auto_level:|
450 OUTPUT Spa;"AUTOLVL"      | Setup an optimum value for the REF LEVEL
460      | according to the measurement signal.
470 GOSUB Wait_mend           | Wait for the end of Auto Level process.
480 RETURN
490 |
500 Wait_mend:|
510 Mend = 0                  | Clear the measurement end flag.
520 ENABLE INTR 7;2          | Enable SRQ interrupt.
530 |
540 IF Mend = 0 THEN GOTO Wait_mend
      | Wait for SRQ interrupt.
550 OUTPUT Spa;"ERRNO?"      | Read the error number.
560 ENTER Spa;Err_num
570 IF Err_num < > 0 THEN GOTO Err_chk
      | The measurement error at the number other than
      | zero.
580 RETURN
590 |
600 Ssrq:                     | SRQ interrupt process routine.
610 S = SPOLL(Spa)           | Read the status byte.
620 Mend = 1                 | Set the measurement end flag.
630 RETURN                   |
640 |
650 Err_chk: |
660 PRINT "Measuring Error. Error Number: ";Err_num
      | Display for the error number.
670 STOP
680 |
690 END

```



# CHAPTER 9

## IN ABNORMALITIES

Read this chapter when the instrument operates abnormal.

---

### CONTENTS

---

1. Inspection and Simple Troubleshooting . . . 9-2
-

# 1. Inspection and Simple Troubleshooting

If the instrument does not operate properly, check the following items before asking for repair. When the trouble cannot be removed by the following countermeasures, contact the Sales and Support Offices or a nearby ADVANTEST office. Their address and phone number are attached at the end of this document.

Symptom	Assumed cause	Remedy
The power cannot be turned on.	Power cable is not surely inserted in the connector.	Turn the power switch OFF, and re-connect the power cable.
	Power fuse is blown.	Replace power fuse.
SWEEP LED lighting up, but no waveform appears on the screen.	INTENSITY is too low.	Adjust by turning the INTENSITY control.
	Input cable or connector is loose.	Reconnect the input cable or connector.
Does not sweep	SINGLE SWEEP Mode	Set to REPEAT.
Inaccurate signal level	AMPTD CAL is not adjusted.	Execute calibration.
Key does not work.	In GPIB remote control mode	When a program is being executed, stop it and press LCL key.
Data cannot be read (recalled) from a memory card.	Defective memory card	Check operation with other memory card.
	Defective drive slot	Contact ADVANTEST and ask for repair.
Data cannot be recorded (saved) in memory card.	Write protection is enabled.	Disable write protection of the memory card.
	The memory card is not initialized.	Initialize the memory card.
	Capacity of the memory card is too small.	Use other memory card.
	Battery of the memory card is down.	Replace battery.



Symptom	Assumed cause	Remedy
Cannot measure with Transient mode, or the measured value is wrong.	SINGLE or REPEAT key is not pressed.	Change the measurement item in Transient mode to get measurement stop status. Press SINGLE or REPEAT key.
	Modulation Accuracy, Transmission Velocity cannot be measured.	The mode is in the state of using SYNC/UNIQ WORD that does not fit to this setup. Set SYNC NO or adjust SYNC/UNIQ WORD to measurement signal.
	Link direction is not correct. (If UPLINK is set at PDC/NADC, it becomes trigger wait because of Burst signal.)	Set Link Direction according to measurement signal. As Leakage Power can be measured with only Burst signal at Carrier OFF, input Burst signal.



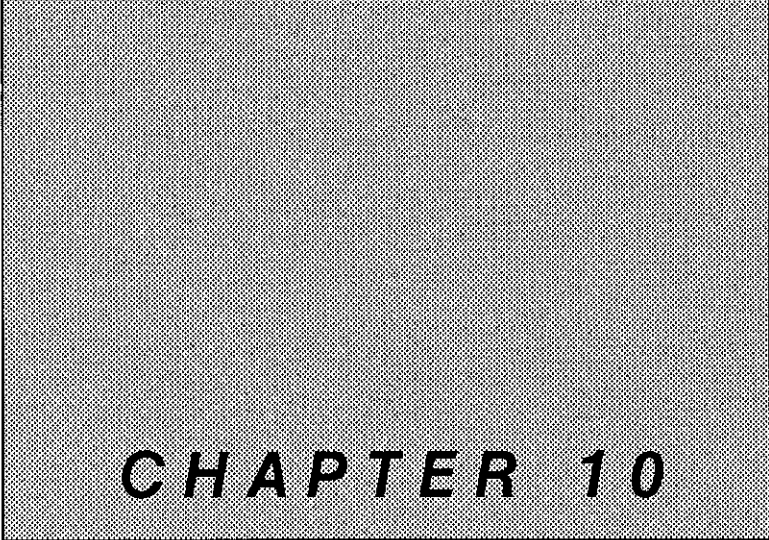

## OPERATION DESCRIPTION

This chapter explains basic operation of each block of this instrument.

---

### CONTENTS

---

1. Description of Operations .....	10-2
2. Block Diagram .....	10-4

---

# 1. Description of Operations

The R3463/3465 mixes the input signal with a 21.4 MHz intermediate frequency (IF) signal. (The input signal must be in the range from 9 kHz to 8.0 GHz.) The signal is then filtered with a variable-resolution bandwidth 21.4 MHz IF filter. The detector (DET) detects the signal, and the signal is digitized and displayed on the screen.

## ■ Mixer Section

### ● Input Frequencies from 9 kHz to 3.0 GHz (R3463/3465)

In the range from 9 kHz to 3.0 GHz, the input signal is fed through the input attenuator (which can attenuate 0 to 70 dB in 10 dB steps) and into the first mixer. The signal then mixes with the local oscillator signal, which is synthesized by the YIG tuning oscillator operating at 4.2 GHz to 7.2 GHz. This creates the first IF signal with a frequency of 4231.4 MHz.

The first IF signal passes through the low noise amplifier (LNA), then to the band pass filter (BPF) to eliminate spurious signals generated by the first and second mixers. (Note that the R3463/3465 does not use the LNA.)

From the band pass filter, the signal passes to the second mixer. There it mixes with a 3810 MHz signal from a phase-locked second local oscillator, and converts into the second IF signal with a frequency of 421.4 MHz.

### ● Input Frequencies 1.7 GHz and Above (Only R3465)

In the range of 1.7 GHz and above, the signal passes through the input attenuator to the tracking filter (a YIG tuning filter), which operates synchronously with the spectrum analyzer tuning frequency. This eliminates images and multiple response from the signal before the signal is fed into the first mixer.

The signal then passes into the first mixer and mixes with the synthesized partial oscillation signal of 3.9 GHz to 8 GHz. This creates the 421.4 MHz IF signal.

This 421.4 MHz IF signal then passes through a bandpass filter (to eliminate the image generated by the third mixer) and on to the third mixer, where it mixes with the local oscillator signal of 400 MHz to create the IF signal of 21.4 MHz. (The third local oscillator signal of 400 MHz is generated by doubling the signal from the 200 MHz oscillator, which is phase-locked to the 10 MHz reference oscillator.)

## ■ IF Section

The 21.4 MHz signal from the mixer section is fed into the IF filter, which has a variable resolution bandwidth from 300 Hz to 3 MHz. The IF section contains a step amplifier (with a 0.1 dB step) to determine the reference level.

The bandwidth filter consists of four stages of 21.4 MHz LC filters, and has a resolution of 300 kHz to 3 MHz. In the range from 100 kHz to 300 Hz, the 21.4 MHz signal is converted to a frequency of 3.58 MHz and fed through the next IF filter. (The 1 kHz and 300 Hz IF filter consists of four stages of crystal oscillators.) The signal is then converted back to a frequency of 21.4 MHz.

## ■ LOG A/D Section

After the resolution bandwidth is determined in the IF section, if the level is displayed in the dB display mode, the signal passes through the LOG amplifier having 100 dB dynamic range. If displayed in the linear display mode, the signal passes through the linear amplifier then goes into a detector (DET). The detected signal is converted into a digital signal by the A/D converter. The digitized signal is controlled by the display section to be displayed on a TFT LCD.

## 2. Block Diagram

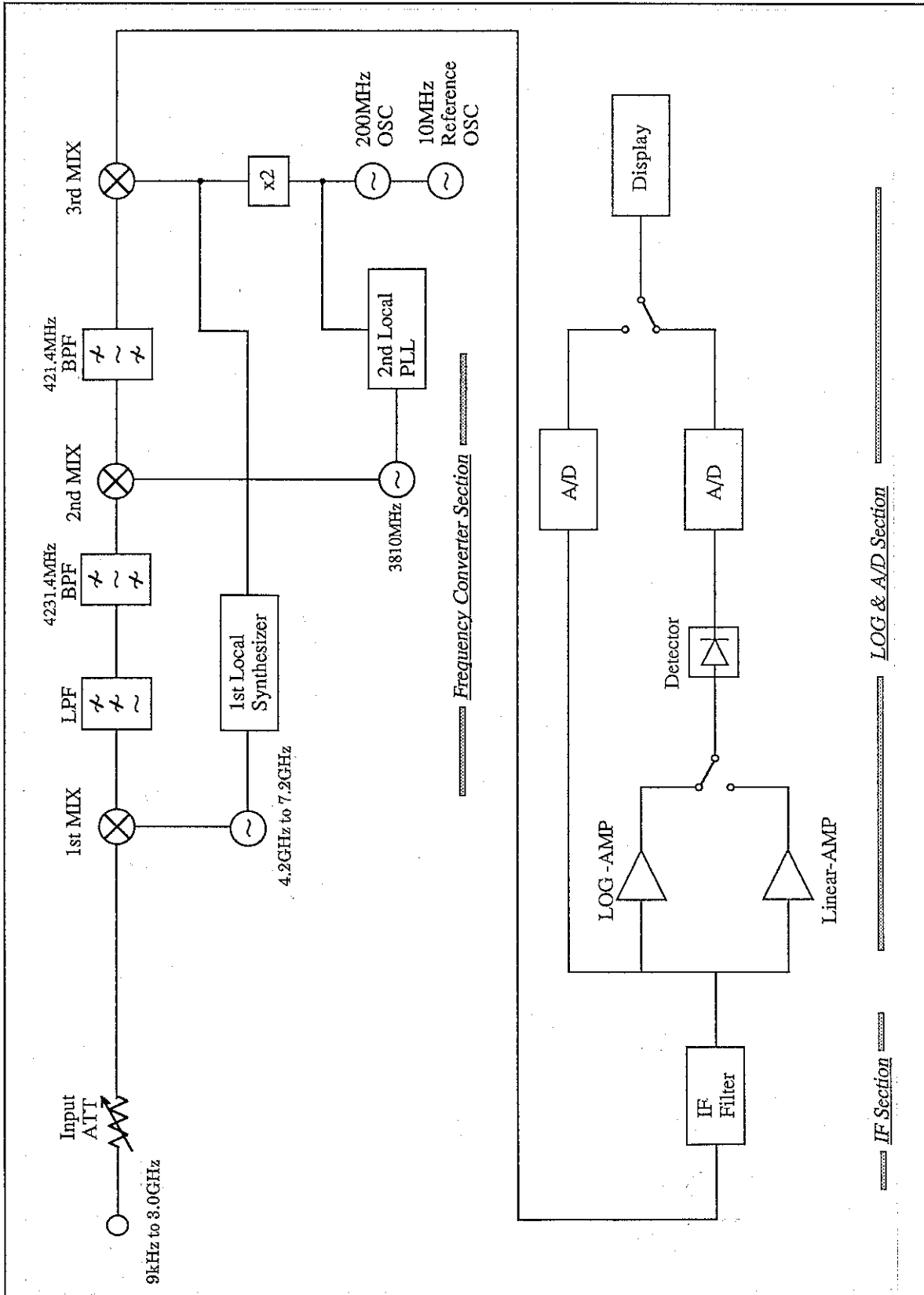

Figure 10-1 Block Diagram of R3463

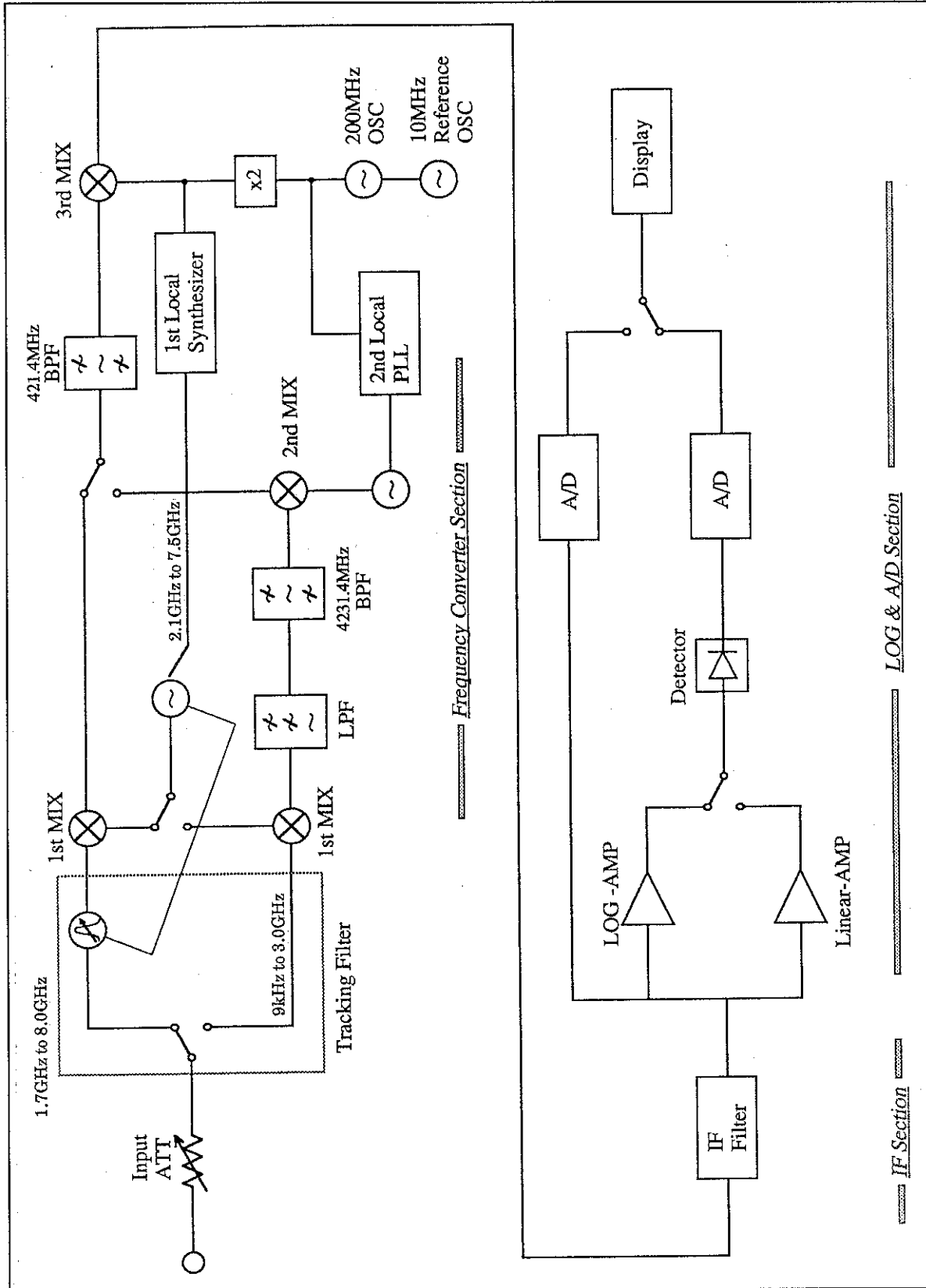
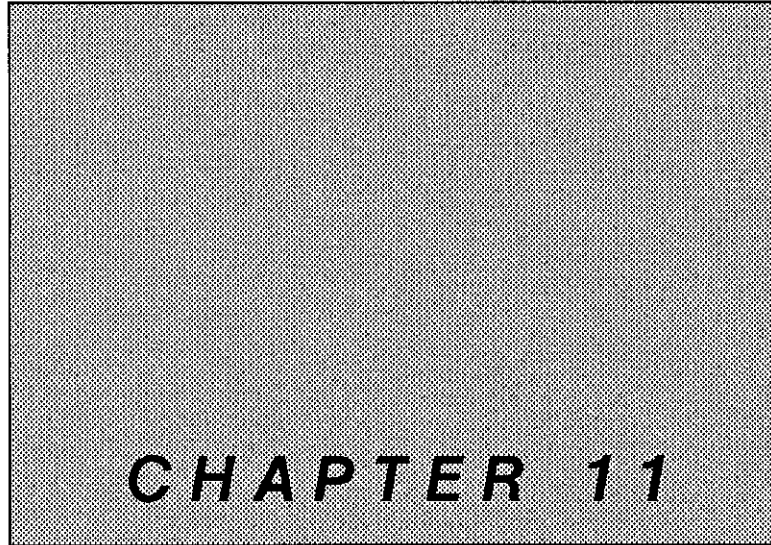

Figure 10-2 Block Diagram of R3465







# CHAPTER 11

## SPECIFICATIONS

This chapter shows specifications for each component of this instrument.

---

### CONTENTS

---

1. R3463/3465 Specifications .....	11-2
------------------------------------	------

---

# 1. R3463/3465 Specifications

## ■ Measurement Function

[CW mode] : Spectrum, OBW, ACP, Harm  
 [Transient mode] : Time Domain measurement, Digital Modulation analysis.

## ■ Frequency Characteristics

### ● Frequency range

	Frequency range	Frequency band	Harmonic mode(N)
R3463/3465	9 kHz to 3.0 GHz	0	1
Only R3465	1.7 GHz to 7.0 GHz	1	1
	6.9 GHz to 8.0 GHz	2	1

### ● Frequency read accuracy (Start, Stop, Center frequency, Marker frequency)

$\pm (\text{Frequency reading} \times \text{Frequency reference accuracy} + \text{Span} \times \text{Span accuracy} + 0.15 \times \text{Resolution bandwidth} + 10 \text{ Hz})$

### ● Marker frequency counter

Resolution 1 Hz to 1 kHz  
 Accuracy (S/N  $\geq$  25 dB)  $\pm (\text{Marker frequency} \times \text{Frequency reference accuracy} + 5 \text{ Hz} \times N + 1 \text{ LSD})$   
 ※ LSD : Least Significant Digit

### ● Frequency reference accuracy

$\pm 2 \times 10^{-8} / \text{Day}$        $\pm 5 \times 10^{-9} / \text{Day (OPT21)}$   
 $\pm 1 \times 10^{-7} / \text{Year}$        $\pm 8 \times 10^{-8} / \text{Year (OPT21)}$

### ● Frequency stability

Residual FM (Zero span)  $< 3 \text{ Hz} \times N_{p-p} / 0.1 \text{ sec}$   
 Drift  $\text{Span} \leq 5 \text{ MHz}, < 20 \text{ Hz} \times [\text{Sweep speed}(\text{min})]$   
 (After 1 hour warm-up)

### ● Signal purity noise side band

$< -100 \text{ dBc/Hz (10 kHz offset)}$   
 $< -110 \text{ dBc/Hz (100 kHz offset)}$

### ● Frequency span

Linear span  
 Range R3463 : 2 kHz to 3 GHz, Zero span  
 R3465 : 2 kHz to 8 GHz, Zero span  
 Accuracy  $\pm 4 \% (\text{Span} > 5 \text{ MHz})$   
 $\pm 1 \% (\text{Span} \leq 5 \text{ MHz})$

- **Resolution bandwidth (3dB)**
  - Range 300 Hz to 3 MHz, 5 MHz (1, 3, 10 sequence)
  - Accuracy  $\pm 20\%$  (Resolution bandwidth 1 kHz to 1 MHz)  
 $\pm 30\%$  (Resolution bandwidth 300 Hz, 3 MHz, 5 MHz)
  - Selectivity  $< 15:1$  (300 Hz to 5 MHz)
- **Video bandwidth**
  - Range 1 Hz to 3 MHz, 5 MHz (1, 3, 10 sequence)
- **Frequency Sweep**
  - Sweep time 50 ms to 1000s (CW mode, Spectrum measurement)
  - Accuracy  $\pm 5\%$
  - Sweep trigger Free run, Line, Single, Video, External
  - Trace / sec 10 times
- **Gated Sweep**
  - Gate Position/Resolution  $1\mu s$  to 65ms/ $1\mu s$
  - Gate Width/Resolution  $2\mu s$  to 65ms/ $1\mu s$
  - Trigger Internal, IF detection, External

## ■ Amplitude Range

- **Measurement range** +30 dBm to Average indicated noise level
- **Maximum safe input**
  - Average continuous power  $\pm 30\text{dBm}$  (1W) (Input  $\text{ATT} \geq 10\text{ dB}$ )
  - DC input 0 V
- **Display range**
  - 10 × 10 Div
  - Logarithmic 10, 5, 2, 1, 0.5 dB/Div
  - Linear (10% of the reference level)/Div
- **Reference level range**
  - Logarithmic -105 dBm to +60 dBm (0.1 dB step)
  - Linear  $1.25\mu\text{ V}$  to 223 V (approx. 1 % step of the full scale)
- **Input attenuator range** 0 to 70 dB (10 dB step)

## ■ Dynamic Range

- **Average display noise level**

	Frequency range	Frequency band	Noise level
R3463/3465	10 kHz	0	-70 dBm
	100 kHz	0	-80dBm
	1 MHz to 3.0 GHz	0	$-\{115-1.55 \times f(\text{GHz})\}$ dBm
Only R3465	1.7 GHz to 7.0 GHz	1	-115 dBm
	6.9 GHz to 8.0 GHz	2	-115 dBm

(Resolution bandwidth : 1 kHz, Input attenuator : 0dB, Video bandwidth : 1Hz)

1. R3463/3465 Specifications

● 1dB gain compression

Frequency range	Mixer input level
> 10 MHz	-5 dBm

● Spurious response

Second harmonic distortion

	Frequency range	Second harmonic distortion	Mixer level
R3463/3465	10 MHz to 3.0 GHz	< -70 dBc	-30 dBm
Only R3465	> 1.7 GHz	< -90 dBc	-10 dBm

Third-Order intermodulation distortion

	Frequency range	Third-Order intermodulation distortion	Mixer level
R3463/3465	10 MHz to 3.0 GHz	< -75 dBc	-30 dBm
Only R3465	> 1.7 GHz	< -75 dBc	-30 dBm

(12.5 kHz Separation, Resolution bandwidth : 300 Hz)

Image/Multiple/Out-of-Band response (Out-of-band response : Only R3465)

	Frequency range	Image/Multiple/Out-of-Band response
R3463	10 MHz to 3.0 GHz	< -70 dBc
R3465	10 MHz to 8.0 GHz	< -70 dBc

Residual response

	Frequency range	Residual response
R3463/3465	1 MHz to 3.0 GHz	< -100 dBm
	300 kHz to 3.0 GHz	< -90 dBm
Only R3465	300 kHz to 8.0 GHz	< -90 dBm

(No input signal, Input ATT : 0dB, 50Ω terminate)

## ■ Amplitude Accuracy

### ● Frequency response

Flatness within the band

	Frequency range	Flatness within the band	Frequency band
R3463/3465	9 kHz to 3.0 GHz	± 1.5 dB	0
	50 MHz to 3.0 GHz	± 1.0 dB	0
Only R3465	1.7 GHz to 7.0 GHz	± 1.5 dB	1
	6.9 GHz to 8.0 GHz	± 1.5 dB	2

(Input ATT 10dB)

Additional error due to band switching (Only R3465 )

Frequency range	Additional error
9 kHz to 8.0 GHz	± 3 dB

(Calibration signal as the reference)

Absolute error referred to calibration signal (Only R3463)

Frequency range	Additional error
9 kHz to 3.0 GHz	± 2 dB

(Calibration signal as the reference)

### ● Calibration signal accuracy(30 MHz)

-10 dBm ± 0.3 dBm

### ● IF gain error (After self-calibration)

	Temperature range	IF gain error
0 dBm to -50 dBm	15 °C to 35 °C	± 0.5 dB
	0 °C to 50 °C	± 0.6 dB

### ● Scale indication accuracy (After self calibration)

Temperature range	Logarithmic	Linear
15 °C to 35 °C	± 0.2 dB/1 dB ± 1 dB/10 dB ± 1.5 dB/80 dB	± 15% of reference level (Within 8 Div)
0 °C to 50 °C	± 0.3 dB/1 dB ± 1.2 dB/10 dB ± 1.5 dB/80 dB	± 20% of reference level (Within 8 Div)

1. R3463/3465 Specifications

● Input attenuator switching error

	Frequency range	switching error
R3463	9 kHz to 3.0 GHz	$\pm 0.1\text{dB}/10\text{dB}$ step, Max. 2.0dB
R3465	9 kHz to 8.0 GHz	$\pm 0.1\text{dB}/10\text{dB}$ step, Max. 2.0dB

(10 dB as the reference ; at 20 to 70 dB)

● Resolution bandwidth switching error

Temperature range	switching error
15 °C to 35 °C	$\leq \pm 0.3$ dB
0 °C to 50 °C	$\leq \pm 0.5$ dB

(Resolution bandwidth: 300 kHz reference, after self-calibration,  $3 \times$  Reference bandwidth  $\geq$  Span, 300 Hz to 3 MHz )

● Pulse quantization error

Logarithmic

Linear

(In pulse measurement mode, PRF > 500/Sweep time)

1.2 dB (Resolution bandwidth  $\leq 1$  MHz)

3 dB (Resolution bandwidth = 3 MHz)

4% of the reference level (Resolution bandwidth  $\leq 1$  MHz)

12% of the reference level (Resolution bandwidth = 3 MHz)

■ Time Domain measurement

● Amplitude resolution

12 bits

● Sweep time

50  $\mu\text{s}$  to 2s/100ns

● Trigger

Free-run, Single, Video, IF detection, External  
Delay trigger/Time 200 ns to 650 ms.

■ Analog Demodulation

● Spectrum demodulation

Modulation type

AM, FM

Audio output

Internal speaker, earphone jack, sound volume adjustable

Demodulation duration

100 ms to 1000 s

■ Digital modulation analysis

● Object modulation method

$\pi/4$  QPSK (PDC, PHS, NADC)

R3463 : In 10 MHz to 3.0 GHz, -30 dBm to +30 dBm

R3465 : In 10 MHz to 7.5 GHz, -30 dBm to +30 dBm



## 1. R3463/3465 Specifications

- **Calibration signal output**
  - Connector BNC female, Front panel
  - Frequency 30 MHz × (1 ± Frequency reference accuracy)
  - Impedance 50 Ω (nominal)
  - Amplitude -10 dBm ± 0.3 dB
  
- **10MHz frequency reference input/output**
  - Connector BNC female, Rear panel
  - Output impedance 50 Ω (nominal)
  - Output frequency accuracy 10MHz × Frequency reference accuracy
  - Input/output amplitude range -5 dBm to +5 dBm
  
- **21.4MHz IF output**
  - Connector BNC female, Rear panel
  - Impedance 50 Ω (nominal)
  
- **421MHz IF output**
  - Connector BNC female, Rear panel
  - Impedance 50 Ω (nominal)
  
- **Video output**
  - Connector VGA(15 pin, female), Rear panel  
640 × 480 dot VGA equivalent
  
- **X axis output**
  - Connector BNC female, Rear panel
  - Impedance 1 kΩ (nominal), DC connection
  - Amplitude approx. -5 V to +5 V
  
- **Y axis output**
  - Connector BNC female, Rear panel
  - Impedance 220 Ω (nominal)
  - Amplitude approx. 2 V in full scale (10dB/DIV)
  
- **Z axis output**
  - Connector BNC female, Rear panel
  - Amplitude TTL level
  - During sweep High level
  - Blanking Low level
  
- **External trigger input**
  - Connector BNC female, Rear panel
  - Impedance 10 kΩ (nominal), DC connection
  - Trigger level TTL level
  
- **Gate input**
  - Connector BNC female, Rear panel
  - Impedance 10 kΩ (nominal)
  - Sweep stop During low mode at TTL level
  - Sweep During high mode at TTL level



- **Voice output(Demodulation audio)**
  - Connector Small-size monophonic jack, Front panel
  - Power output Maximum 0.2 W, 8  $\Omega$  (nominal)
- **Probe power**
  - 4 pin connector, Front panel
  - Voltage + 12.6V, -12.6V
  - Current Max. 100mA each
- **I/O**
  - GPIB IEEE-488, bus connector, Rear panel
  - RS-232 D-SUB 9 pin, Rear panel
  - P-I/O D-SUB 25 pin, Rear panel
  - EXT-KEY DIN, Front panel
- **Direct print**
  - Output with 'ESC/P' or 'HP PCL' command
- **Memory card**
  - 2 slots, Front panel
  - Connector JEIDA-Ver 4.0 / PCMCIA 2.0 or more
- **Program loader**
  - Option

## ■ General Specifications

- **Temperature and humidity**
  - During operation 0°C to 50°C
  - When stored -20°C to 60°C
  - Relative Humidity 85% or below
- **Power source**
  - During 100VAC operation
    - Rated Voltage 100 V to 120 V
    - Power consumption 300 VA or below
    - Frequency 50 Hz/60 Hz
  - During 220VAC operation
    - Rated Voltage 220 V to 240 V
    - Power consumption 300 VA or below
    - Frequency 50 Hz/60 Hz
- **Mass**
  - R3463 :16.5 kg or below
  - R3465 :17 kg or below
  - (Excluding optional blocks, front cover, and accessories)
- **Dimensions**
  - Approx. 177 mm (Height) × 350 mm (Width) × 420 mm (Depth)
  - (Excluding the handle, feet and front cover)

1. R3463/3465 Specifications

■ Options

Option 08	RX control	
Option 15	Program loader	
Option 73	FM deviation	
Option 75	Constellation	
Option 76	Graphics	
Option 51	GSM added	} Only R3465
Option 56	GSM only	
Option 77	GSM graphics	

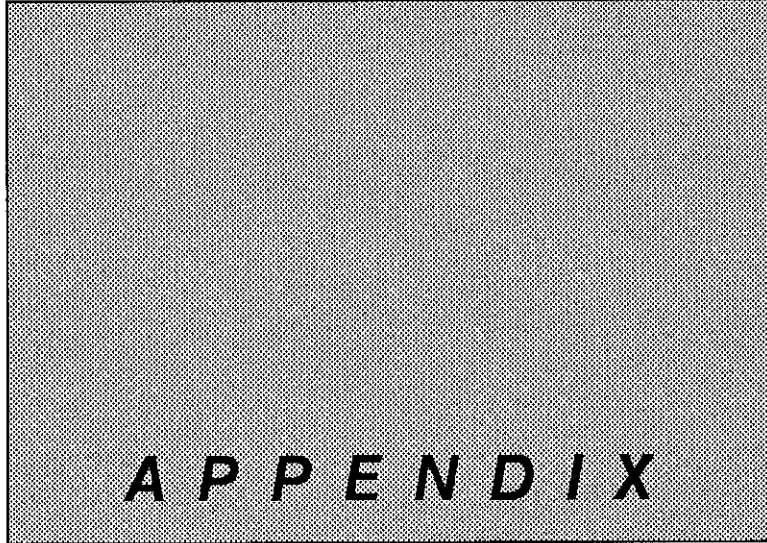

**A P P E N D I X**

In this appendix, you will find a glossary, a menu lists and list of messages.

---

**CONTENTS**

---

1. Glossary .....	A-2
2. dB Conversion Formulas .....	A-7
3. Menu Lists .....	A-8
4. Restriction on the IC Card .....	A-21
5. List of Messages .....	A-22

---

# 1. Glossary

## [B]

### Bandwidth Accuracy

The bandwidth accuracy of the IF filter is expressed by the deviation from the nominal value of the 3dB-lowered point. This efficiency has almost no effect on measurement of normal signals of continuous level, but it should be taken into consideration when measuring the level of a noise signal.

### Bandwidth Switching Accuracy

Several IF filters are used to obtain optimal resolution (in signal spectrum analysis) according to the scan width. When switching from one IF filter to another while measuring one and the same signal, an error is generated for the difference in loss. This error defined as the bandwidth switching accuracy.

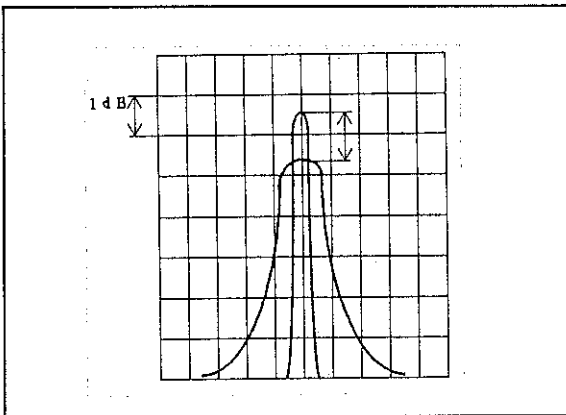

Figure A-1 Bandwidth Switching Accuracy

## [E]

### Electromagnetic compatibility (EMC)

The ability of a system to operate without producing or being affected by electromagnetic interference.

### Electromagnetic interference (EMI)

Electromagnetic interference (EMI) is a disturbance in the reception of desired signals caused by unwanted electromagnetic energy, or something. EMI can be caused by any source of EM energy, such as (list a pertinent rew). Modern circuits are designed to produce as little EM energy as possible, but since the EM can not be completely eliminated. the cabinets containing EM-can not equipment are shielded to exclude EMI.

## [F]

### Frequency Response

This term represents amplitude characteristics (frequency characteristics) for a given frequency.

In the spectrum analyzer, frequency response means the frequency characteristics (flatness) of input attenuator and mixer for the input frequency, and is given in  $\pm \Delta$  dB.

## [G]

### Gain Compression

If the input signal is greater than a certain value, the correct value is not displayed on the CRT and the input signal appears as if it were compressed. This phenomenon is called gain compression, and is expressed the linearity of the input signal range. Max gain compression is 1dB.

## [I]

### IF Bandwidth

The spectrum analyzer uses band pass filter (BPF) to analyze the frequency components contained in the input signal. The 3dB bandwidth of the BPF is called the IF band (See Figure A-2(a)).

The BPF characteristics should be set according to the sweep width and the sweep speed used for the waveform.

This spectrum analyzer sets the optimal value according to the sweep width. In general, smaller bandwidths improve resolution. Therefore, the resolution of the spectrum analyzer can be expressed by the narrowest IF bandwidth (See Figure A-2 (b)).

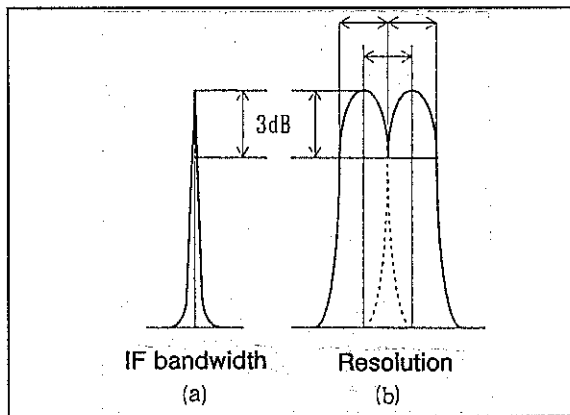

Figure A-2 IF Bandwidth

**[M]****Maximum Input Level**

This is the maximum level allowed for the input circuit of the spectrum analyzer. The level can be modified by the input attenuator.

**Maximum Input Sensitivity**

This is maximum sensitivity of the spectrum analyzer to detect signals. The sensitivity is affected by the noise generated by the spectrum analyzer itself and depends on the IF bandwidth. The maximum input sensitivity is normally expressed as the average noise level in the minimum IF bandwidth of the spectrum analyzer.

**[N]****Noise Sideband**

The spectrum analyzer efficiency is lowered by the noise generated in the local oscillator and phase lock loop of the analyzer itself, which will appear in the vicinity of the spectrum on the CRT.

To compensate for this, the sideband of the analyzer itself is defined so that signals out of the sideband can be analyzed in a certain range. This range is called the noise sideband.

The spectrum analyzer's noise sideband characteristics are expressed in the following example.

**Example:**

Suppose the IF bandwidth is 1kHz, -70dB at 20kHz apart from the carrier. The noise level is normally expressed by the energy contained in the 1Hz bandwidth. (See Figure A-3 (b).)

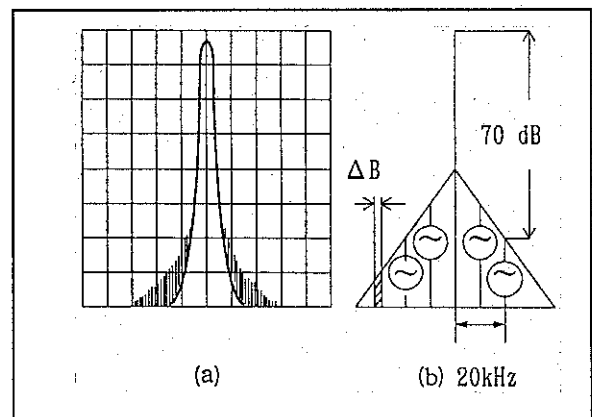

Figure A-3 Noise Sideband

If this is expressed in 1Hz bandwidth: Since the value is -70dB when the bandwidth is 1kHz, the signals within the 1Hz bandwidth will be lower than this by about  $10 \log 1\text{Hz}/1\text{kHz}$  [dB], or about 30dB; consequently, it is expressed as -100dB/Hz at 20kHz apart from the carrier when the IF bandwidth is 1kHz.

**[O]****Occupied Bandwidth**

Modulation causes the frequency spectrum of an EM signal to spread significantly. The occupied bandwidth is the portion of the signals that contains 99% of the total average power radiated (See Figure A-4).

1. Glossary

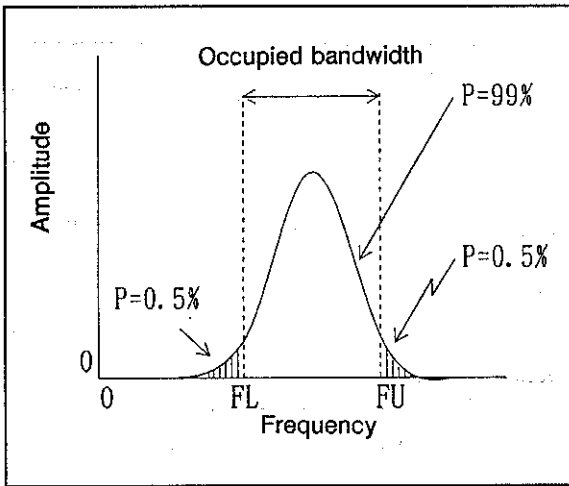

Figure A-4 Occupied Bandwidth

[Q]

**Quasi-Peak Value Measurements**

In radio communication, EMI usually appears as an impulse. To evaluate this interference, the analyzer uses the noise power in proportion to the peak value. The measurement bandwidth and detection constant used for this evaluation are called quasi-peak value measurements, and are determined by JRTC specifications (in Japan) and CISPR specifications (international).

[R]

**Reference Level Display Accuracy**

When reading the absolute level of an input signal on the spectrum analyzer, the level is determined by the distance in dB from the uppermost scale on the screen. The level set for this uppermost scale is called reference level. The reference level is modified by the IF GAIN key and the input attenuator, and displayed in dBm or dBμ. The absolute accuracy of this display is the reference level accuracy.

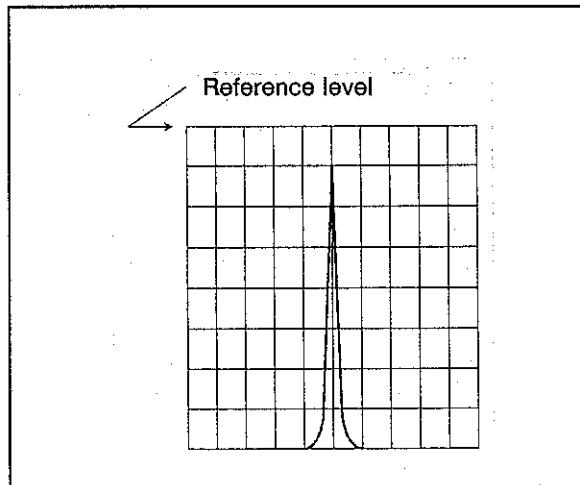

Figure A-5 Reference Level

**Residual FM**

The short-period frequency stability of the local oscillators built in the spectrum analyzer is expressed as residual FM. The frequency width fluctuating per unit time is expressed by p-p. This also determines the measurement limit value when measuring the residual FM of the signal.

**Residual Response**

Residual response is a measure of how much (in the input level calculation) the spurious signal generated in the spectrum analyzer is suppressed. Residual response is generated by leaks of particular signals such as local oscillation output in the spectrum analyzer. This should be taken into consideration when analyzing a precise input signal.

**Resolution Bandwidth Selectivity**

The band pass filter normally attenuates Gauss distribution instead of so-called rectangular characteristics. Consequently, if two adjacent signals of different sizes are mixed, the smaller signal "hides" at the tail of the larger signal (See Figure A-6). Therefore, the bandwidth at a certain attenuation range (60dB) should also be defined. The ratio between the 3dB width and 60dB width is expressed as the bandwidth selectivity.

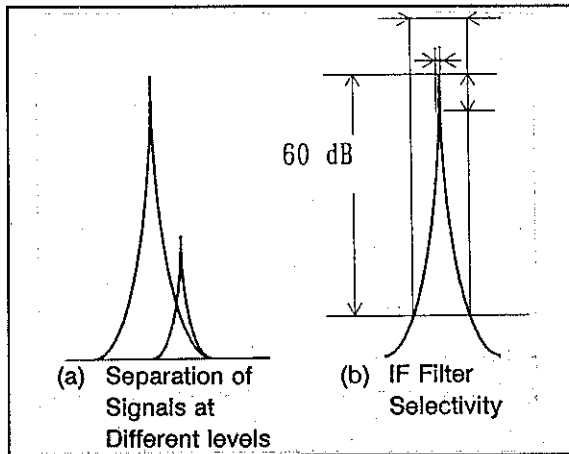

Figure A-6 Bandwidth Selectivity

[S]

### Spurious Response

This is distortion caused by the higher harmonic spurious signal generated in the input mixer when the signal level is increased.

The range that can be used without distortion varies according to the input level of the basic wave. In the example shown Figure A-7, the range is from -30dBm to -70dB. If the input signal level is too great, the input attenuator is used to decrease the signal fed to the mixer so that a proper input level can be obtained.

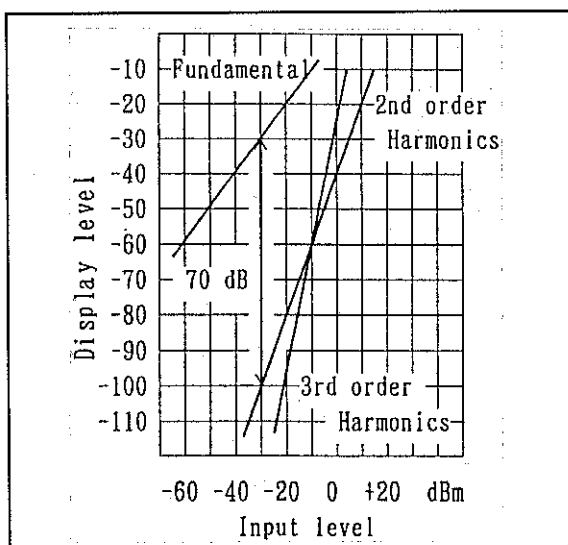

Figure A-7 Spurious Response

### Spurious Signals

Spurious signals are undesired signals that can interfere with the target signal. Spurious signals can be divided into several types as follows:

#### Higher Harmonic spurious

This is the higher harmonic level generated by the spectrum analyzer itself (normally in the mixer circuit) when an ideal undistorted signal is fed to the analyzer. This also means the efficiency to measure higher harmonic distortion.

#### Adjacent spurious

This is the small spurious signal generated in the vicinity of the spectrum when a pure, single-spectrum signal is fed to the spectrum analyzer.

#### Non-higher Harmonic spurious

This is a spurious signal of a certain inherent frequency generated by the spectrum analyzer itself. This is also called residual response.

[V]

### Voltage Standing Wave Ratio (VSWR)

This is a constant that represents the impedance matching state. It is expressed as the ratio between the maximum and minimum values in the standing wave generated as a combination of progressive wave and reflected wave in the spectrum analyzer loaded against the ideal nominal impedance source. This is a variation of reflection factor and reflection attenuation amount.

In Figure A-8, the value of signal  $E_1$  received at the receiver (spectrum analyzer input) is identical to that of  $E_0$  if  $E_0$  is transmitted to the receiver without impedance mismatching. If the signal is completely reflected due to mismatching of the receiver and returned to the transmitter, the ratio of reflection, i. e., the reflection factor can be expressed as follows, assuming  $E_R$  as the reflected wave size:

1. Glossary

Reflection factor  $\Gamma = \frac{\text{Reflected wave } ER}{\text{Transmitted wave } E_0}$

Return loss (dB) =  $20 \log ER / E_0$  [dB]

VSWR =  $(E_0 + ER) / (E_0 - ER)$

The relationship to the reflection factor will be:

VSWR =  $(1 + |\Gamma|) / (1 - |\Gamma|)$

The VSWR will be in the range 1 to  $\infty$ . The matching state is improved as the value approaches 1.

[Z]

**Zero Span**

The spectrum analyzer sweeps at any frequency along the horizontal axis as the time axis but will not sweep in zero span mode.

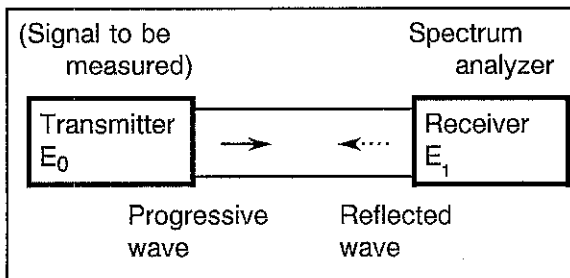

Figure A-8 VSWR

[Y]

**YIG-tuned Oscillator**

This was first reported by Griffiths in 1946. Garnet ferrites such as YIG (Yttrium-iron garnet) monocrystal show extremely sharp electron spin resonance in the microwave area, and has a resonance frequency in proportion to the direct-current magnetic field applied over a wide frequency range.

Therefore, YIG crystals can be used for wide-range electronic tuning, changing the current exciting the elector magnet that generates direct current magnetic field. YIG crystals are used in the local sweep generator of the spectrum analyzer and in other devices such as auto microwave frequency counters.



## 2. dB Conversion Formulas

### Definitions

$$\begin{array}{ll} 0\text{dBV} = 1\text{V}_{\text{rms}} & Y\text{dBV} = 20\log \frac{X\text{V}}{1\text{V}} \\ 0\text{dBm} = 1\text{mW} & Y\text{dBm} = 10\log \frac{X\text{mW}}{1\text{mW}} \\ 0\text{dB}\mu\text{V} = 1\mu\text{V}_{\text{rms}} & Y\text{dB}\mu\text{V} = 20\log \frac{X\mu\text{V}}{1\mu\text{V}} \\ 0\text{dBpw} = 1\text{pW} & Y\text{dBpw} = 10\log \frac{X\text{pW}}{1\text{pW}} \end{array}$$

### Conversion formulas

If  $R = 50 \Omega$ :

$$\begin{array}{l} \text{dBV} \cong (\text{dBm} - 13\text{dB}) \\ \text{dB}\mu\text{V} \cong (\text{dBm} + 107\text{dB}) \\ \text{dB}\mu\text{V}_{\text{emf}} \cong (\text{dBm} + 113\text{dB}) \\ \text{dBpw} \cong (\text{dBm} + 90\text{dB}) \end{array}$$

If  $R = 75 \Omega$ :

$$\begin{array}{l} \text{dBV} \cong (\text{dBm} - 11\text{dB}) \\ \text{dB}\mu\text{V} \cong (\text{dBm} + 109\text{dB}) \\ \text{dB}\mu\text{V}_{\text{emf}} \cong (\text{dBm} + 115\text{dB}) \\ \text{dBpw} \cong (\text{dBm} + 90\text{dB}) \end{array}$$

### Examples

Converting 1mV into dB $\mu$ V:  $20\log \frac{1\text{mV}}{1\mu\text{V}} = 20\log 10^3 = 60\text{dB}\mu\text{V}$

Converting 0dBm into dB $\mu$ V:  $\begin{cases} 0\text{dBm} + 107\text{dB} = 107\text{dB}\mu\text{V} (R = 50\Omega) \\ 0\text{dBm} + 109\text{dB} = 109\text{dB}\mu\text{V} (R = 75\Omega) \end{cases}$

Converting 60dB $\mu$ V into dBm:  $\begin{cases} 60\text{dB}\mu\text{V} - 107\text{dB} = -47\text{dBm} (R = 50\Omega) \\ 60\text{dB}\mu\text{V} - 109\text{dB} = -49\text{dBm} (R = 75\Omega) \end{cases}$

Converting 10V/m into dB $\mu$ V/m:  $20\log \frac{10\text{V/m}}{1\mu\text{V/m}} = 140\text{dB}\mu\text{V/m}$

### Relationship between dBm and Watt

+50dBm	+40dBm	+30dBm	+20dBm	+10dBm	+0dBm	-10dBm	-20dBm	-30dBm
100W	10W	1W	100mW	10mW	1mW	0.1mW	0.01mW	0.001mW

### 3. Menu Lists

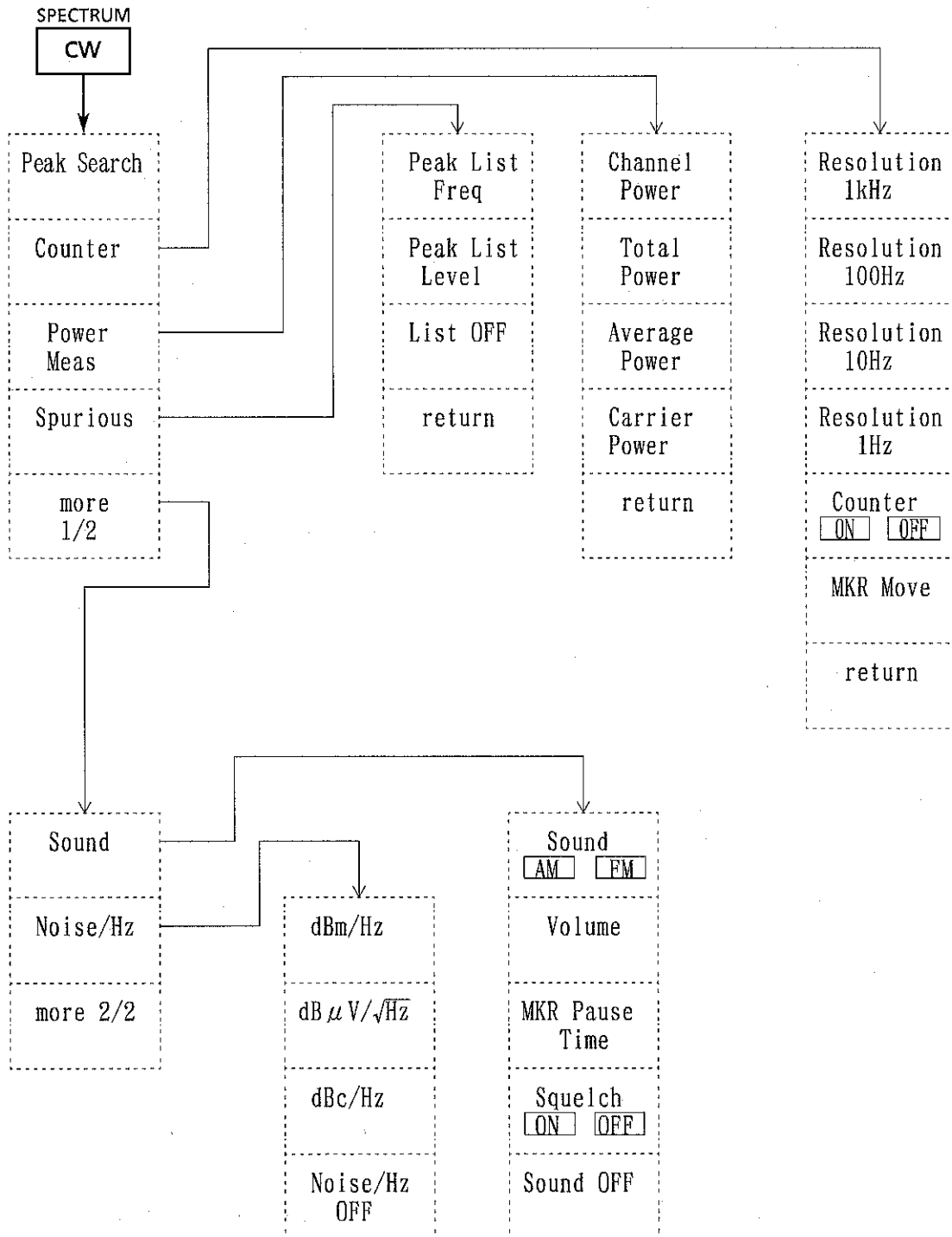

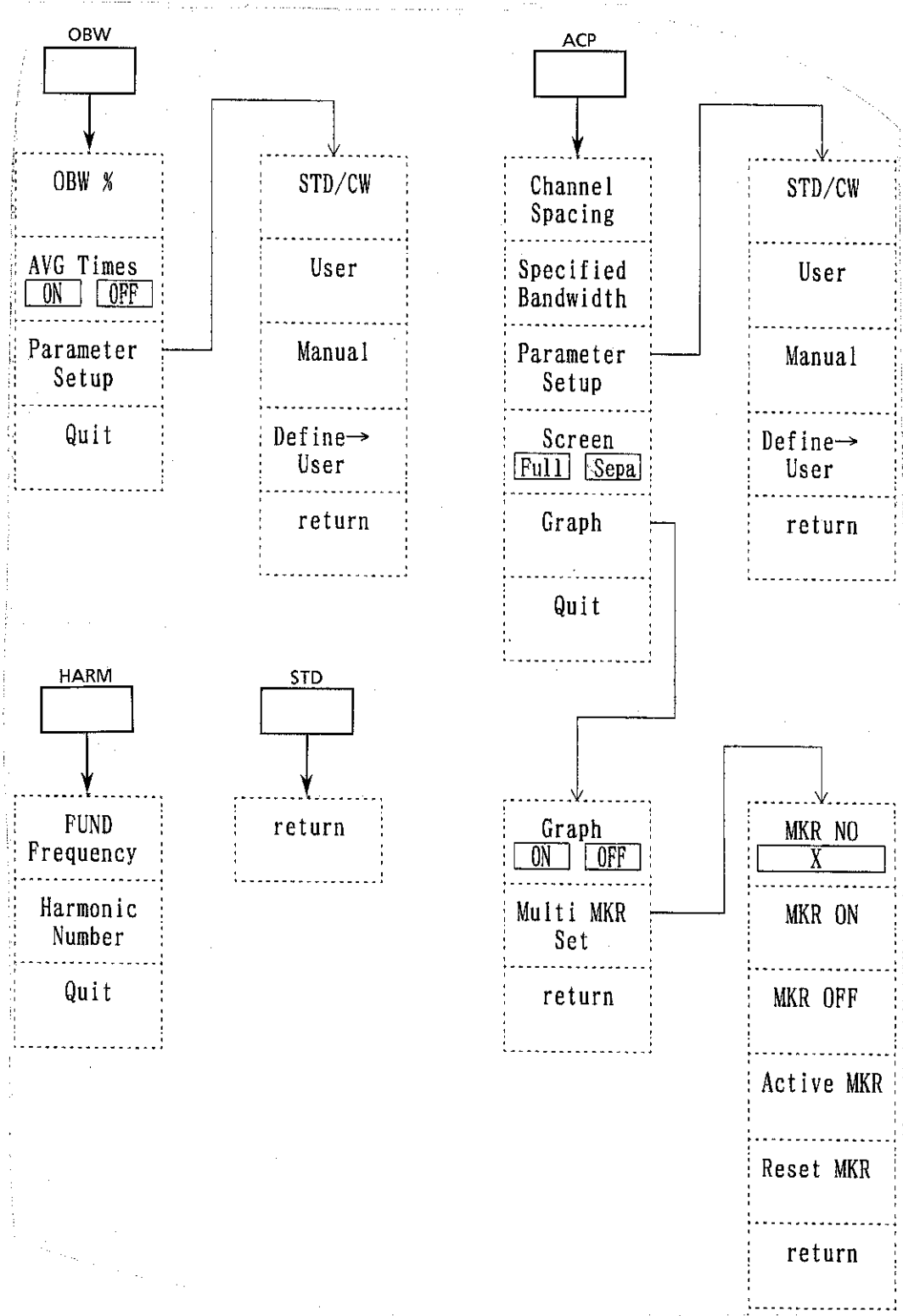

3. Menu Lists

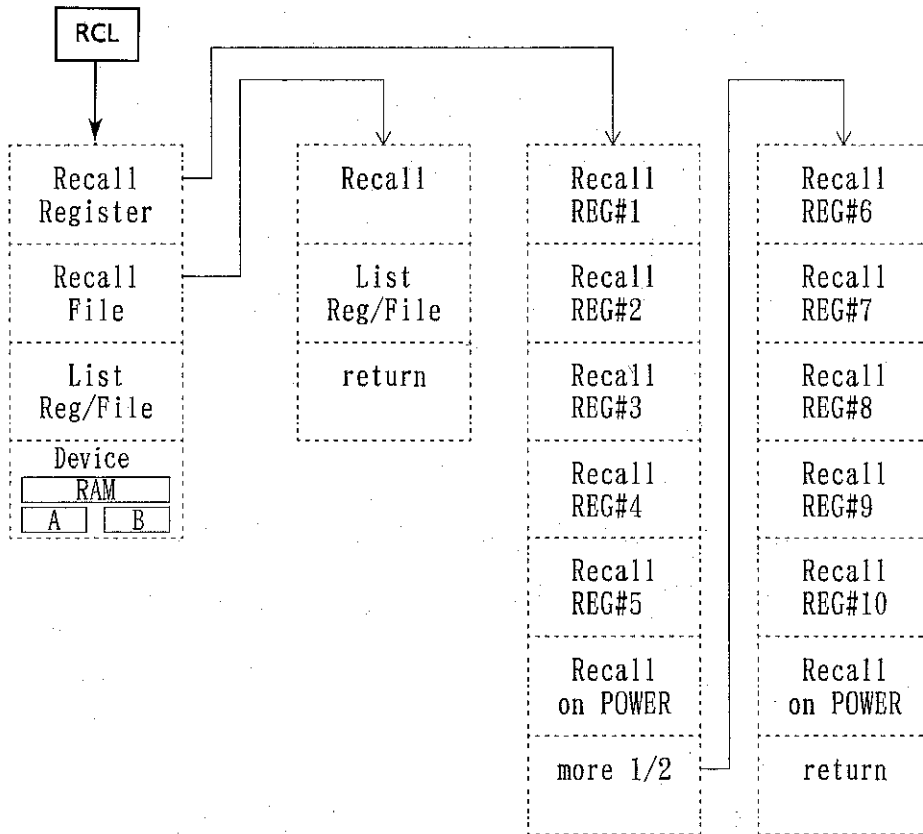

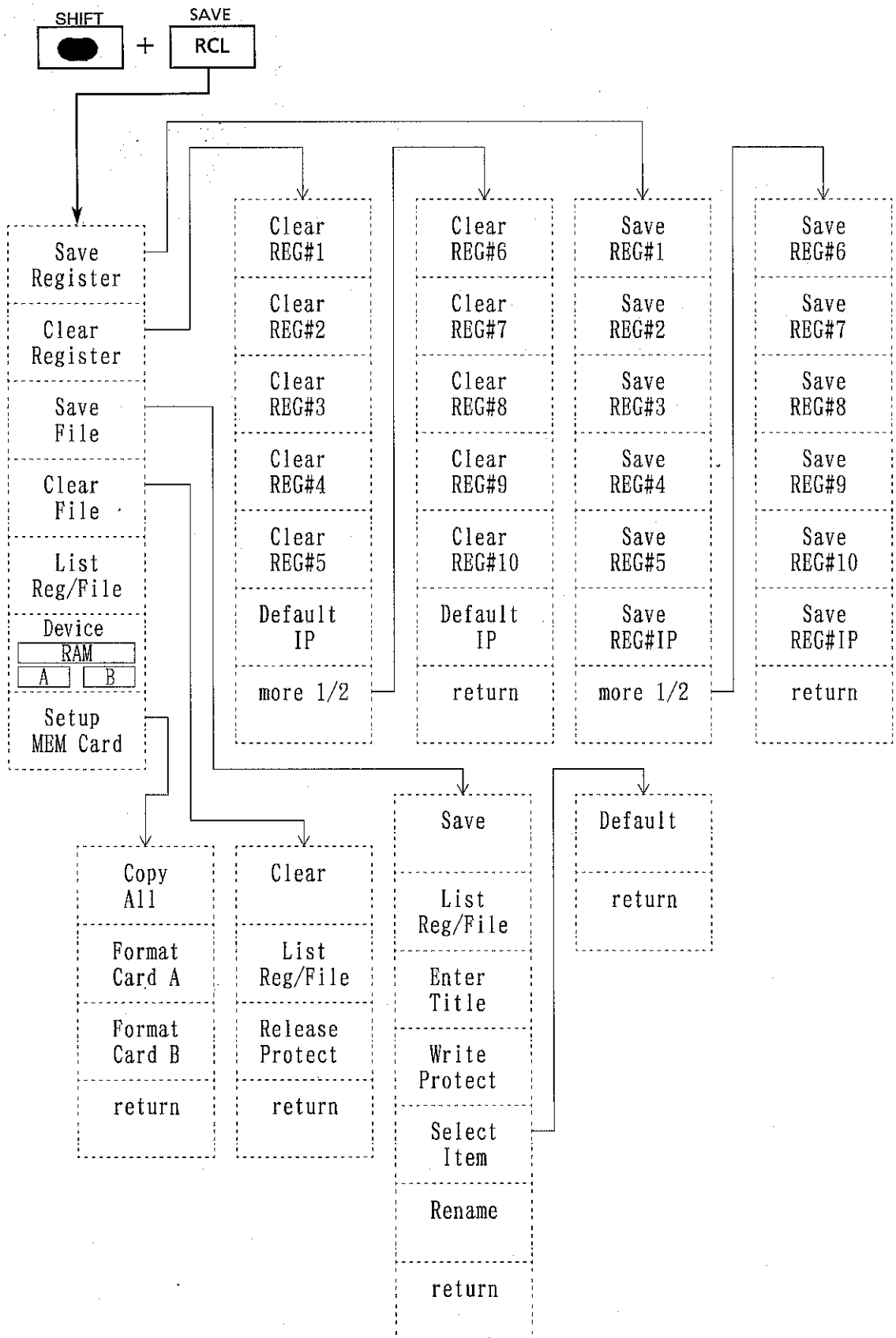

3. Menu Lists

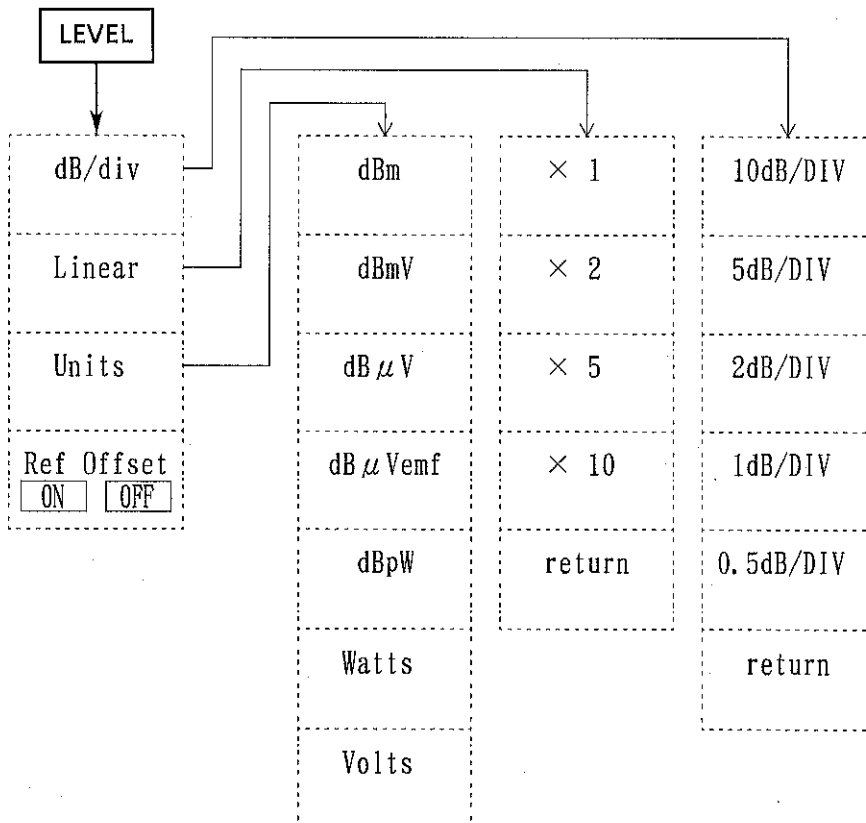
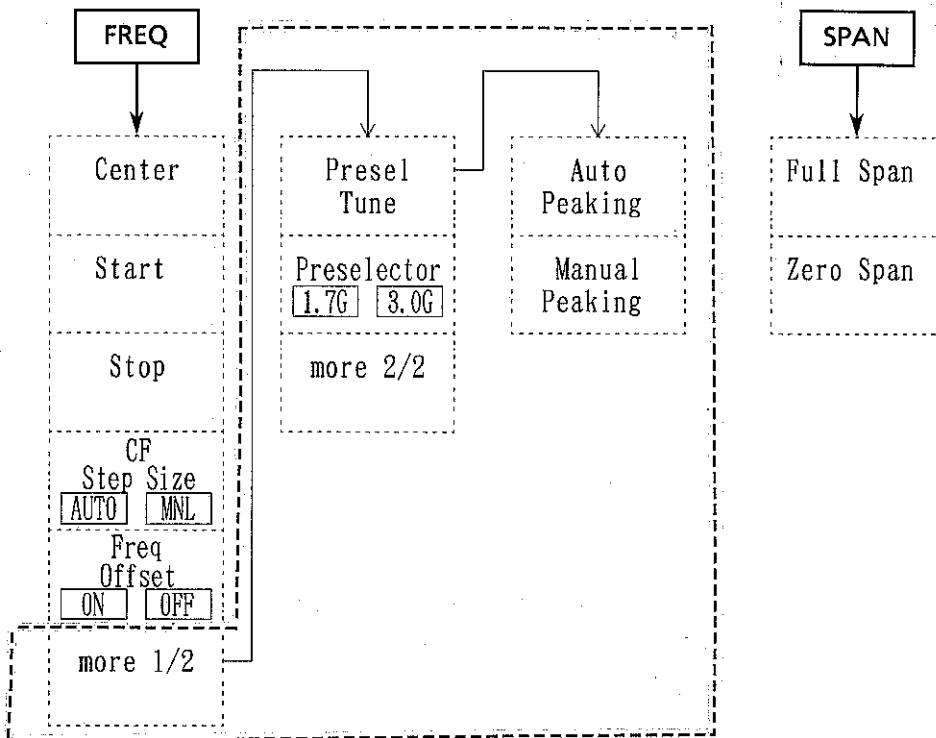

**Note**

The menu items enclosed with a long dashed line are displayed on R3465 but not displayed on R3463.

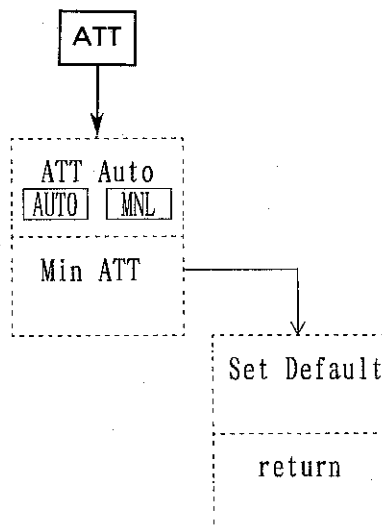
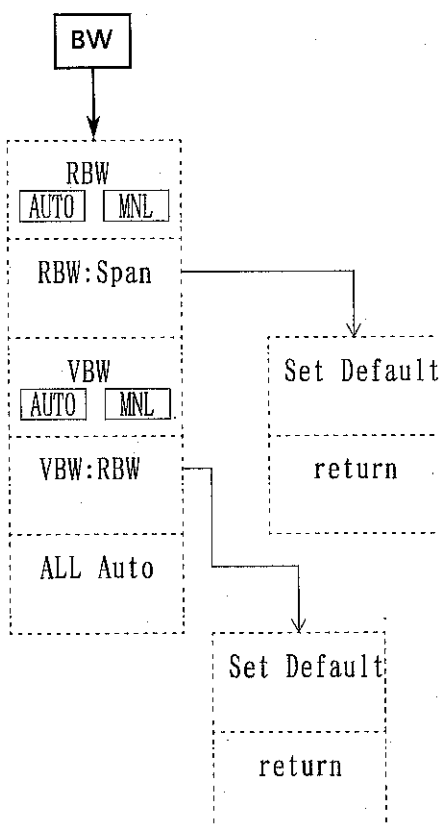
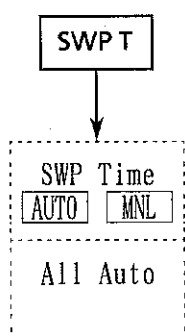
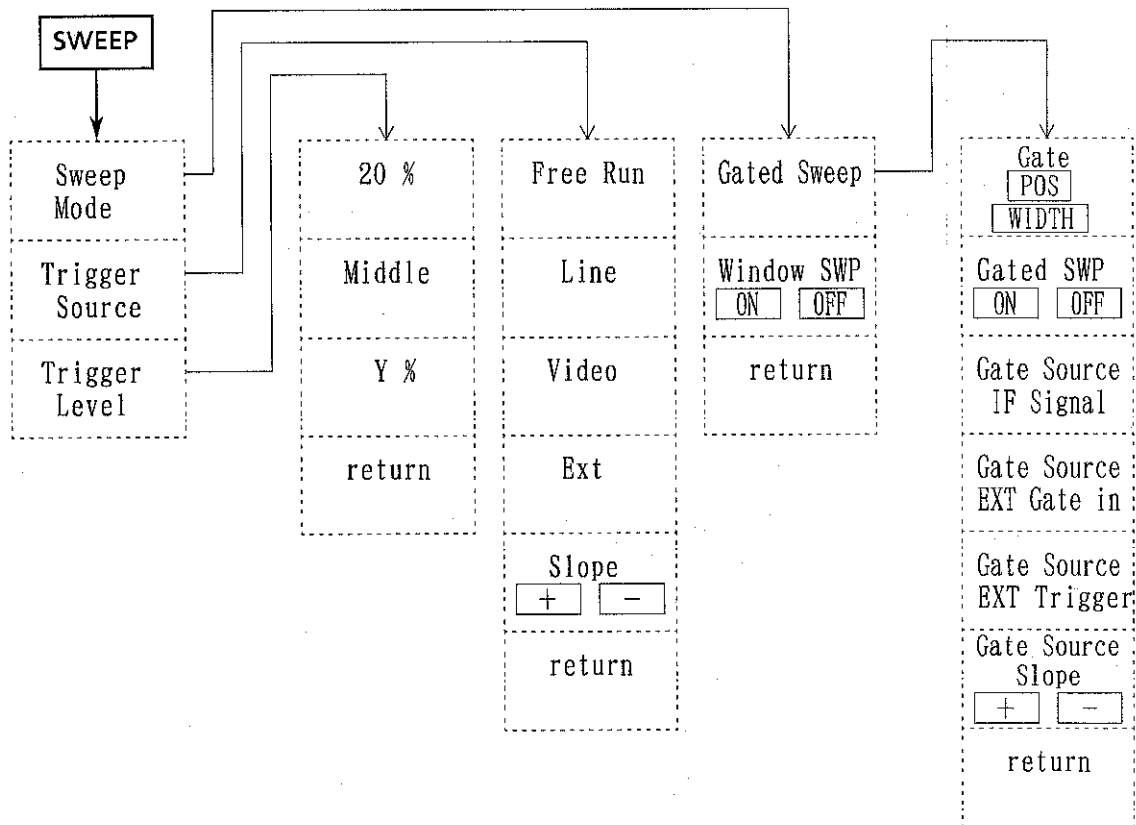

3. Menu Lists

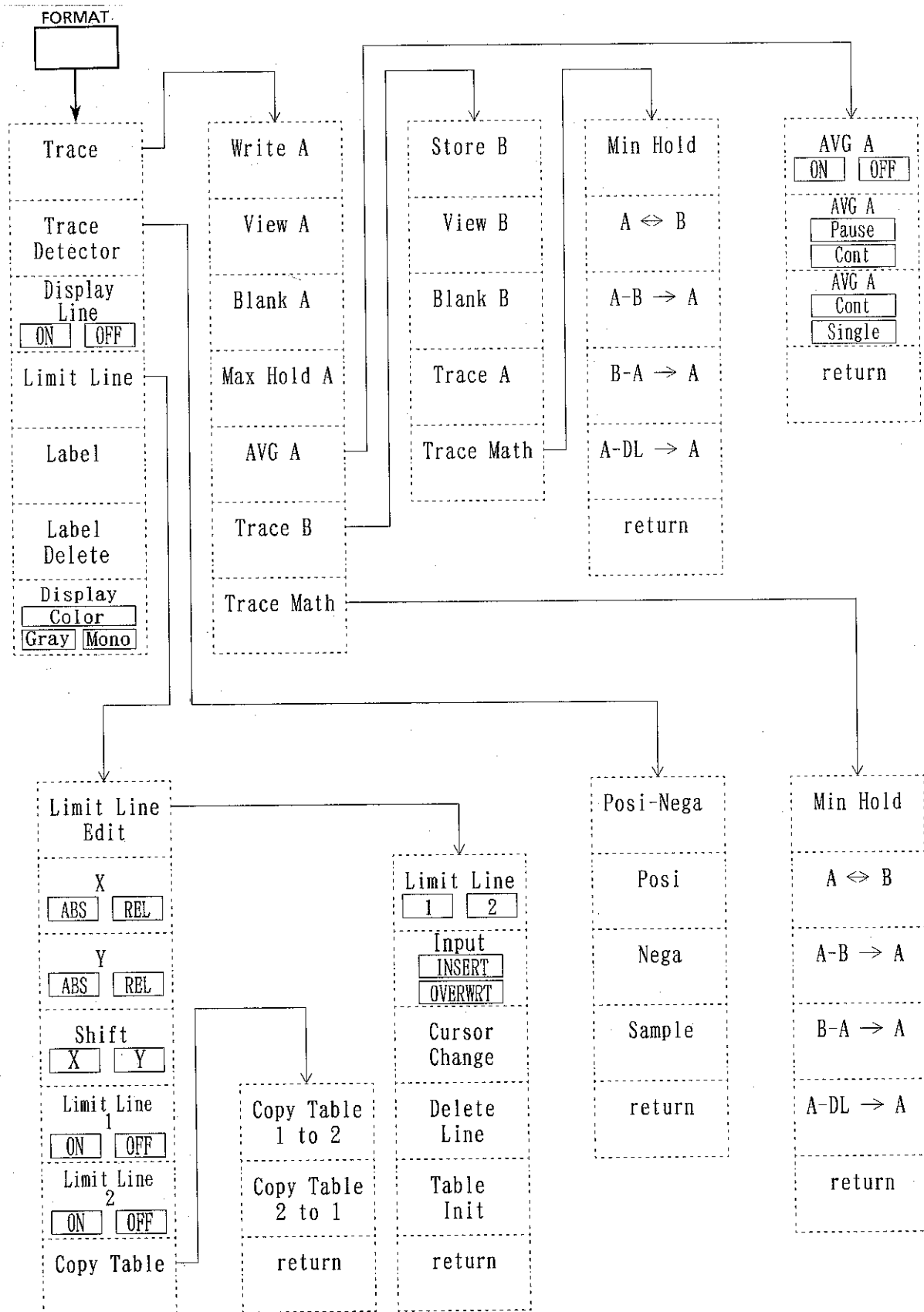



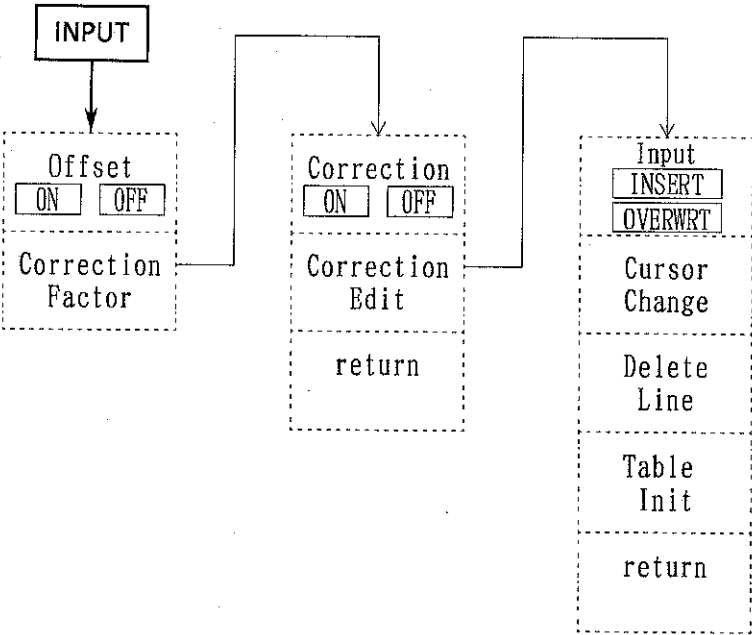
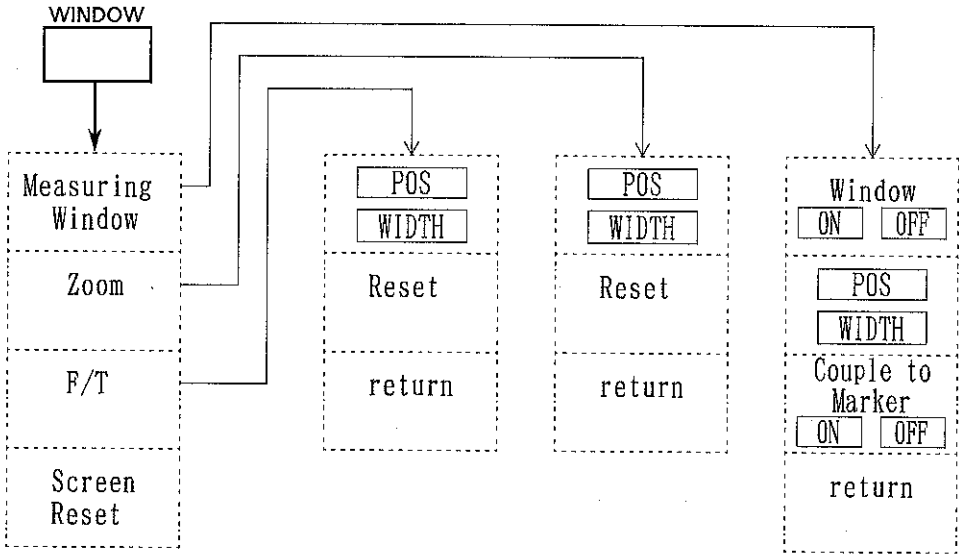

3. Menu Lists

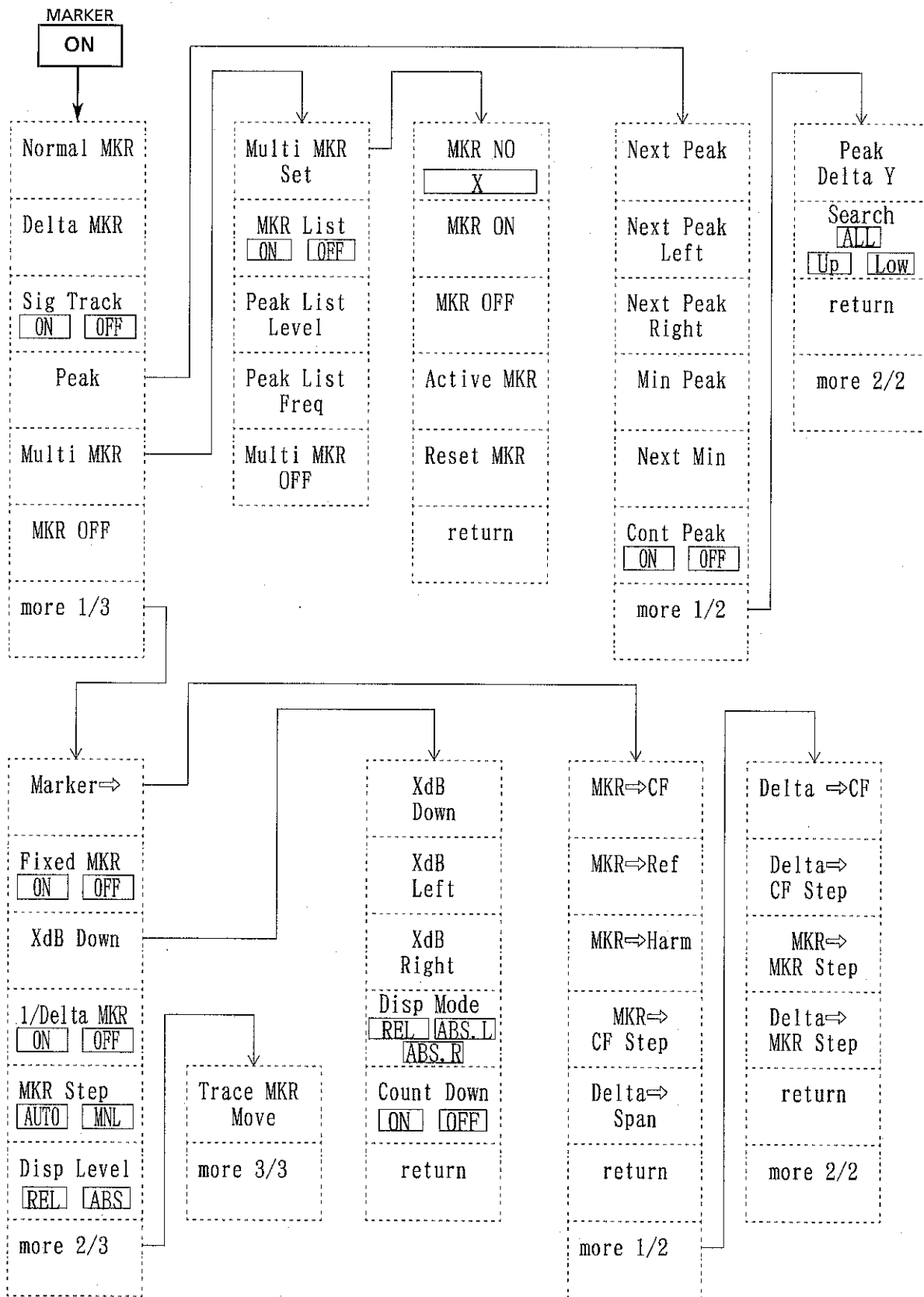

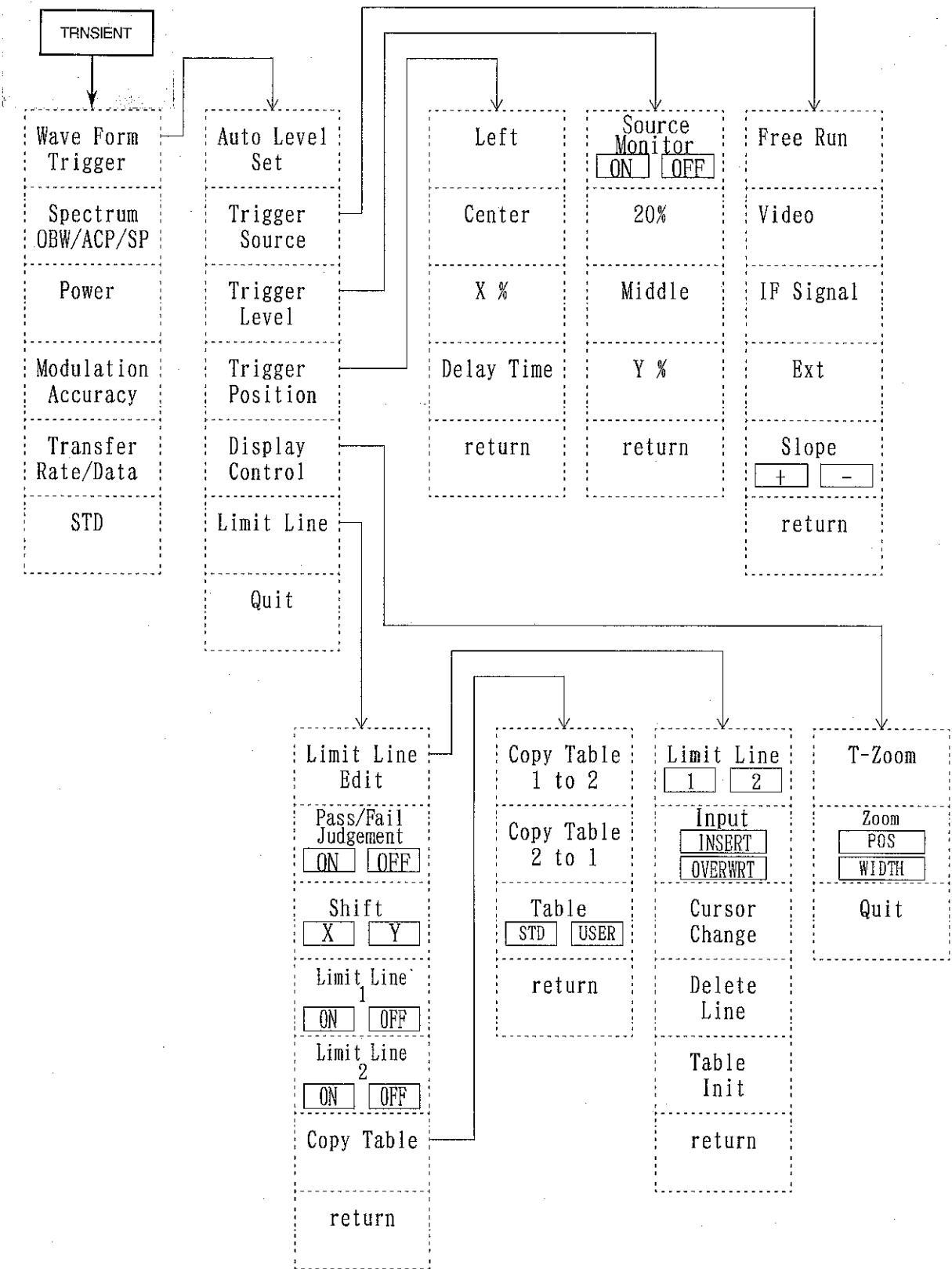

3. Menu Lists

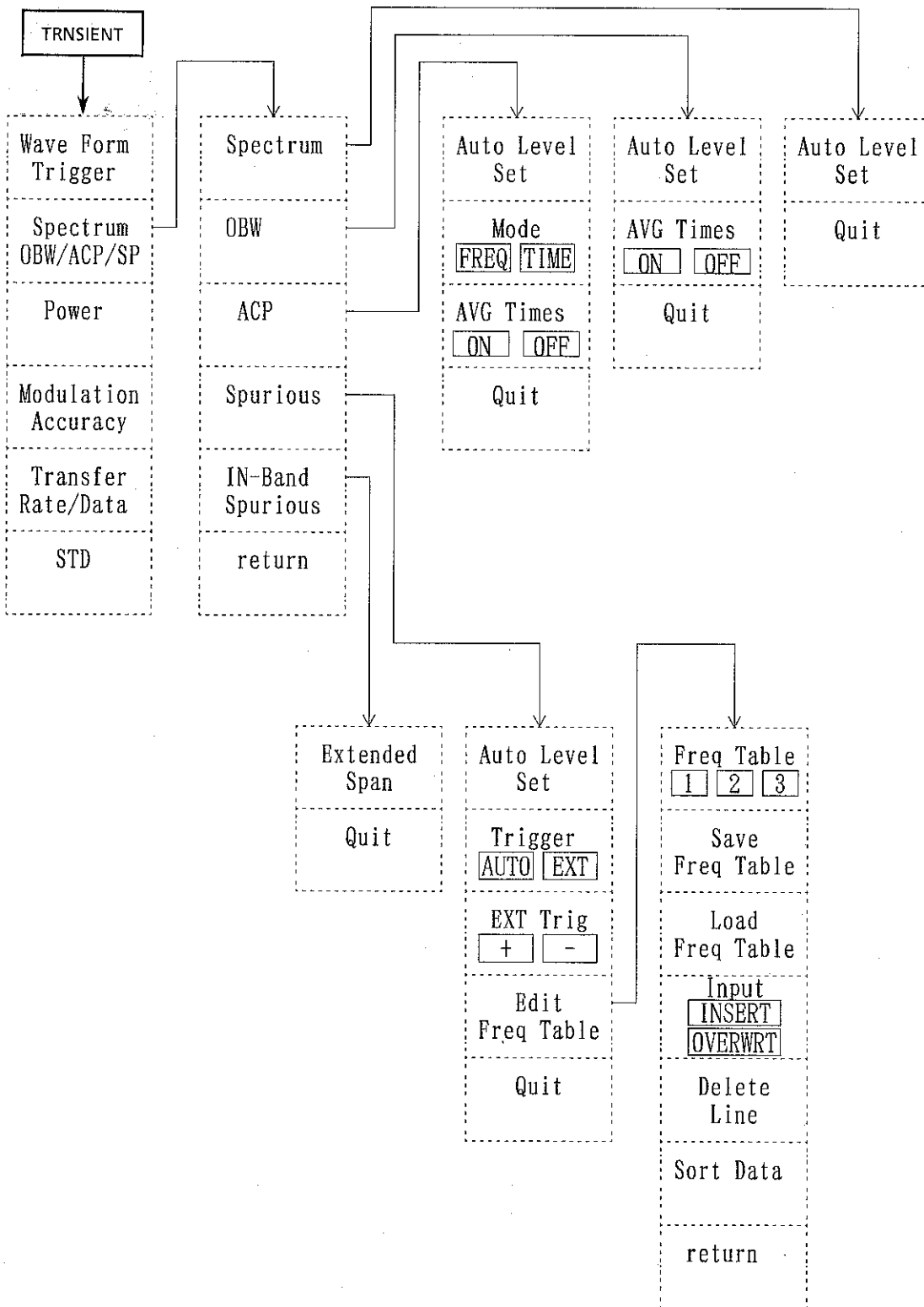

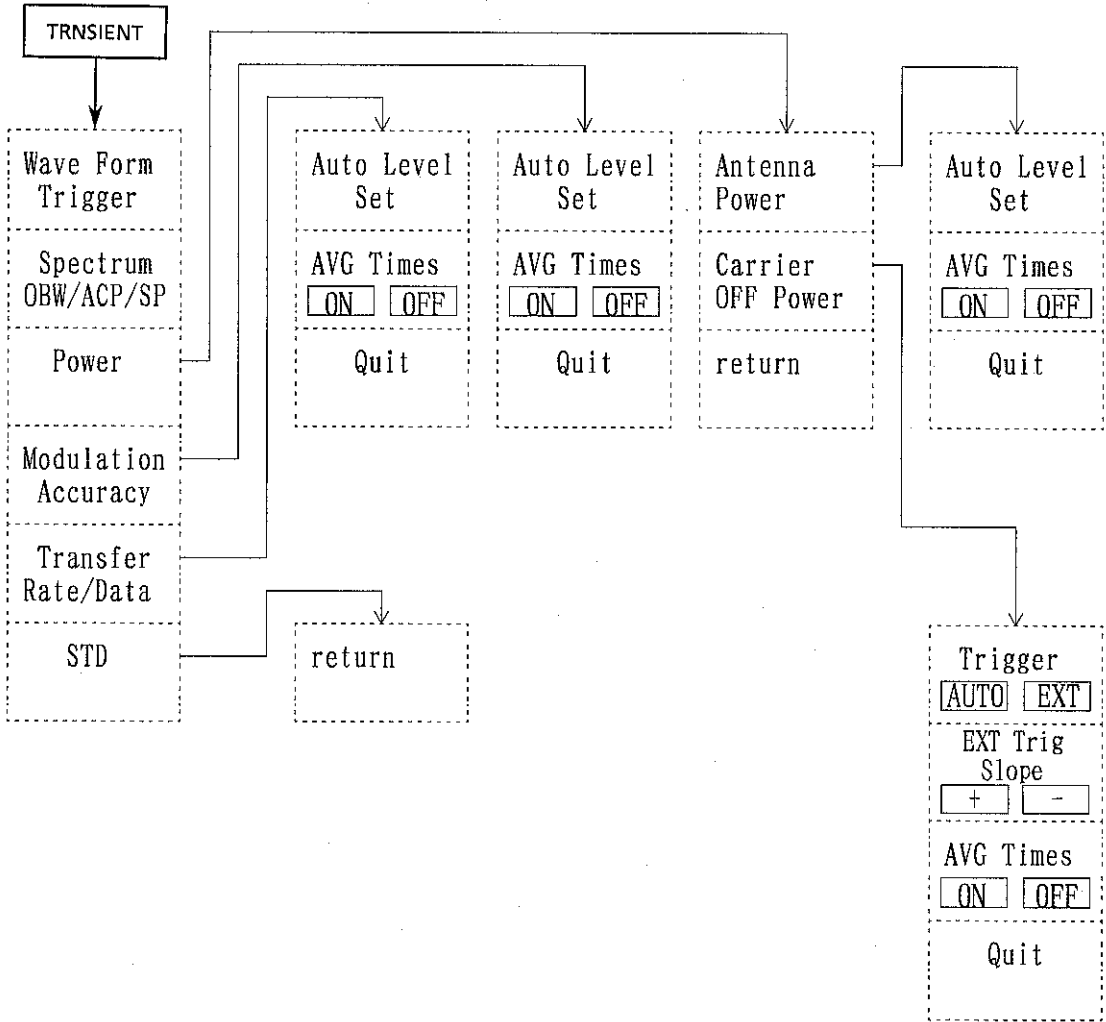

3. Menu Lists

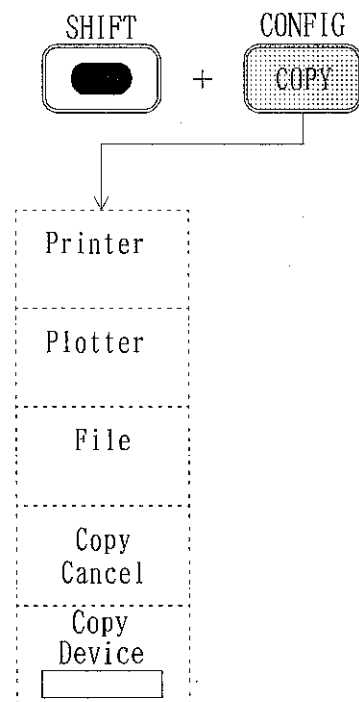
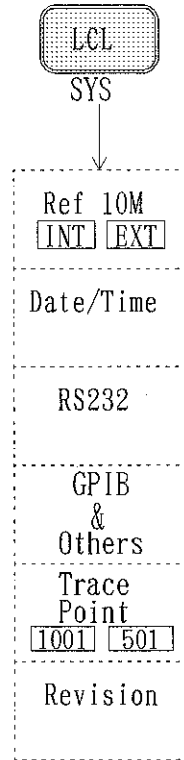
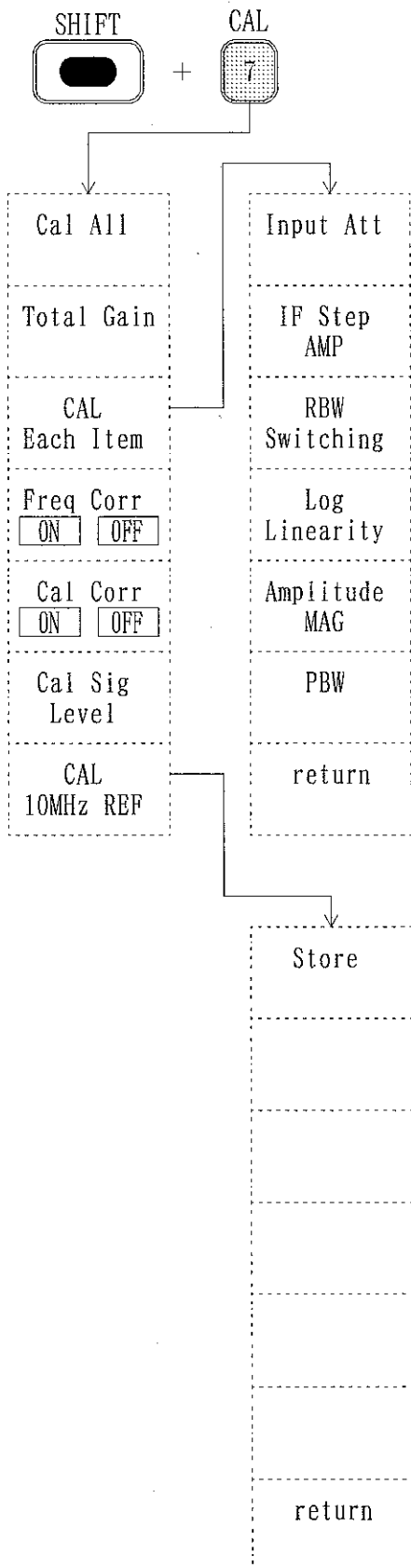

## 4. Restriction on the IC Card

Some cards that even comply with the JEIDA standards cannot be written, read or formatted in this instrument. Please do not use especially the cards that have no attribute memories in them or the cards that have the information of the attribute memories not accurate. Those cards that can be used in PC and so on cannot be used in this instrument.

The restrictions of the usable cards in this instrument are described below.

### ■ Usable Cards

#### ● SRAM Card

It is permitted to be handled as a floppy disk device.

- JEIDA 4.0 (PCMCIA 2.0) or higher and have capacity 64KB or larger.
- Work with both of that with attribute memory and that without attribute memory.
- Deal with the cards that have no attribute memories or have no contents even if there are the attribute memories as below.
  - Write/Read-out/(Physical/Logical) Format enable
  - It is dealt with as the sector placed at the head of the common memory without single partition/ECC (Error Check Cord).
- Deal with the cards that have only the level1 device information as the attribute information as below.
  - Write/Read-out/(Physical/Logical) Format enable
  - It is dealt with as the sector placed at the head of the common memory without single partition/ECC (Error Check Cord).
- Deal with the cards that have up to the level2 format information as the attribute information as below.
  - Physical format disable
  - It depends on that it is with ECC or without ECC that it enables or disables to read-out or to write.
    - Without ECC: Read-out/Write/Logical format enable
    - With ECC: Only Read-out enable
- The cards that have plural partition comply with only the partition that is described in the first format information. (Only in the case that partition is the basic DOS partition.)

### ■ Nonusable Cards

- EPROM card/Flash memory card  
Independent on With attribute memory/Without attribute memory.
- DRAM card
- I/O card

## 5. List of Messages

Message	Explanation	Error No.
Sound demodulation is working. Please turn off the Sound mode. [CW 1/2]	Sound demodulation is working.	1
Vertical scale is Linear mode. Please select any dB/div scale. [Level- > dB/div]	Vertical scale is set in the Linear mode.	2
Preselector is been tuning. Please select Manual Peaking. [Freq 2/2]	Preselector is been tuning.	3
This parameter is fixed while. Preselector Peaking. [Freq 2/2]	This parameter is not be able to be changed while Preselector Peaking.	4
Span is set 0 Hz. Please change a span.	It is set in Zero Span.	5
OBW, ACP or HARM is working. Please quit the measure.	Standards measurement is in execution.	6
Blank trace is selected. Please select Write mode. [Format- > Trace A]	It is not able to be executed because it is set in Blank trace.	7
Not available on baseband freq. Please move marker and execute.	It is not able to be executed on Baseband frequency.	8
Power Measure is working. Please turn off each item. [CW- > Power Meas]	Power Measure is working.	9
Signal Track is working. Please turn off Signal Track. [Marker 1/3]	Signal Track is working.	10
Noise/Hz is working. Please quit the Noise/Hz. [CW 2/2]	Noise/Hz is working.	11
Only dBm and dBuV is useful while Noise/Hz is been working.	It is not possible to select because Noise/Hz is been working.	12



Message	Explanation	Error No.
Counter is working. Please turn off the Counter. [CW 1/2]	Counter is working.	13
$\Delta$ MKR is not active. Please activate the $\Delta$ MKR. [Marker 1/3]	The delta marker is not active.	14
Not available in Multi Screen. Please reset Multi Screen mode. [Window 1/1]	It is not able to be executed in Multi Screen mode.	17
View or Blank trace is selected. Please select Write mode. [Format->Trace A]	It is not able to be executed in View/Blank.	18
Trigger source is not Video. Please select Video trigger. [Sweep->Trigger Source]	Trigger source is not Video.	19
MKR is not on Trace A. Please execute Trace MKR Move. [Marker 3/3]	The marker is not on Trace A.	20
Vertical scale is not 10 dB/div. Please select 10 dB/div. [Level->dB/div]	The vertical scale is not 10 dB/div.	22
Parameter is set over the scale. Please check the data. [ACP 1/1]	The parameter is not correctly set.	23
Screen mode is fixed up by STD. [ACP->Parameter Set Up]	The screen mode is fixed.	24
Calculated power is out of range.	The calculated power is out of range.	25
Edit table is opened. Please return to execute menu.	It is not able to be executed in the Edit mode.	26
Frequency table is empty. Please edit a table and execute.	There are no table data.	27
Calibration signal was not detected. Please check CAL OUT signal.	There is no CAL signal.	28

## 5. List of Messages

Message	Explanation	Error No.
Trace Average is working. Please turn Average off. [Format->Trace A]	Trace average is working.	39
Not available in Freq. ACP mode.	Cannot execute in Freq. ACP mode.	40
Trace Point is set to 501. Please change mode to 1001. [SYS 1/1]	Trace 501 Point mode is set.	41
Not available while Zooming.	It is not able to be executed while Zooming.	42
No trace data. Please start a measure.	Trace data is not displayed. Start the measurement.	43
Attenuator is MANUAL mode Please select AUTO mode.	Attenuator is set to the MANUAL mode. Change the mode to Auto, then execute the measurement.	44
No margin for filtering.	There's no margin for filtering in trigger position.	200
Invalid Sync Word.	As Sync Word can be detected only one, slot cannot be recognized.	201
Multiple Sync Word was detected.	Plural Sync Words were detected.	202
Invalid Sync Word and no margin for filtering.	As there's no margin for filtering in trigger position and Sync Word can be detected only one, slot cannot be recognized.	203
Trigger occurs in a slot.	Trigger is in a slot.	204
Printer is not ready. Please check a printer setting.	It is not able to be printed. Please check the printer setting.	300*
Printer cable problem. Please check a cable or connection.	The printer cable is defective. Please check the cable or connection.	301*
Printer is not active.	The printer is not active.	302*
Plotter cable problem or Plotter is not active.	The plotter cable is defective or the plotter does not operate.	303*
INPUT ATT: Calibration failure.	It is a failure of the Calibration.	400

Message	Explanation	Error No.
IF STEP AMP FAILURE: Please verify EXT reference and setting. Then repeat.	It is a failure of the Calibration. Please verify the 10 MHz reference setting. Change the setting of the reference or connect the EXT reference correctly and then try the calibration again.	401
LOG LINEARITY: Calibration failure.	It is a failure of the Calibration.	402
TOTAL GAIN: Calibration failure.	It is a failure of the Calibration.	403
RBW SWITCHING: Calibration failure.	It is a failure of the Calibration.	404
AMPTD MAG: Calibration failure.	It is a failure of the Calibration.	405
Calibration data is not enough. Please execute CAL ALL.	It is not able to be executed because the calibration data is not enough.	406
HS ADC: Calibration failure.	It is a failure of the Calibration.	407
MOD DSP: Calibration failure.	It is a failure of the Calibration.	408
NORMAL ADC: Calibration failure.	It is a failure of the Calibration.	409
Illegal parameters.	The specified parameters are illegal.	600
Illegal file or device name.	The file or device name is illegal.	601
Software version unmatched.	Software version is unmatched.	602
Cannot format a device. (Note)	The memory card not enough is not able to be initialized.	603
Cannot rename a file in RAM disk.	The file name in RAM disk cannot be changed.	604
Broken saved block data.	The saved data is broken.	605
Device already exists.	The device already exists.	606
Device not found.	There are no devices.	607
Device not ready.	The device cannot be referred.	608

**Note:**

*If the connection of memory card is bad, try format again after the insertion and extraction of it.*

## 5. List of Messages

Message	Explanation	Error No.
Directory not found.	There are no directories.	609
File already exists.	The file already exists.	610
File not found.	There are no files.	611
Invalid BPB. Please format a card.	BPB is invalid. The card needs to be initialized.	612
Cannot delete a file. (read-only file)	It is not able to be deleted because it is a read-only file.	613
No disk space.	Card/Disk capacity is full.	614
Read-only file.	It is the read-only file.	615
Read-only media.	It is the read-only media.	616
Read-only volume.	The card is in the write protection.	617
Invalid boot sector signature.	The boot sector signature cannot be recognized.	618
CRC error.	CRC error occurred.	619
File or register empty.	It is impossible to recall a file or a register that is empty.	634
Any trouble in DSP or AD module.	DSP or AD module has some trouble.	620
Broken Freq-Correction data. Please report to qualified service person.	An error of the frequency characteristic correction data occurred.	621*
Handshake error occurred to TBC. Please report to qualified service person.	A handshake error occurred.	622*
Handshake error occurred to DSP. Please report to qualified service person.	A handshake error occurred.	623*
Cannot detect Mod. DSP board. Please report to qualified service person.	Connection error has occurred.	624*
Time Out ! No Trigger detected.	Trigger is not detected.	700
System Error. Cannot allocate memory.	Cannot allocate memory space.	701
Input level is out of range. Please check Reference level.	Input level is out of allowable range.	702

Message	Explanation	Error No.
Burst signal is not detected. Please check Burst length.	Burst signal cannot be detected.	703
Cannot demodulate.	Cannot demodulate.	704
Sync Word is not detected. please check STD menu.	Sync Word cannot be detected.	705
Sync Word detection failure.	Failed in Sync Word detection.	706
Trigger timing is not proper.	Trigger timing is not proper.	707
Phase Error is out of limit.	Phase Error is out of allowable limit.	708
Signal Type is set to CONTINUOUS. Please set BURST in STD menu.	Continuous wave was detected.	709
Link Type is set to VOX. Cannot measure VOX signal.	VOX type cannot be measured.	710
The last process is in progress.	The process in progress becomes to be the last one by pressing STOP key.	800*
Auto Level completed !	Auto level completed.	801*
Auto Level failed !	Auto level failed.	802*

**Note :** It is possible to read error numbers by using the GPIB query, "ERRNO?", but impossible to read codes marked by (\*).



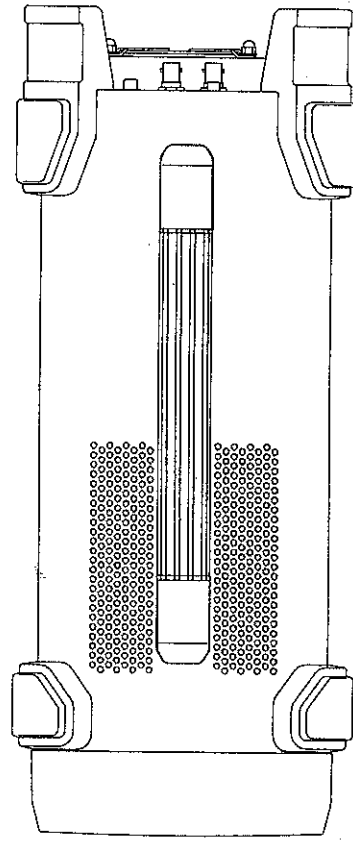
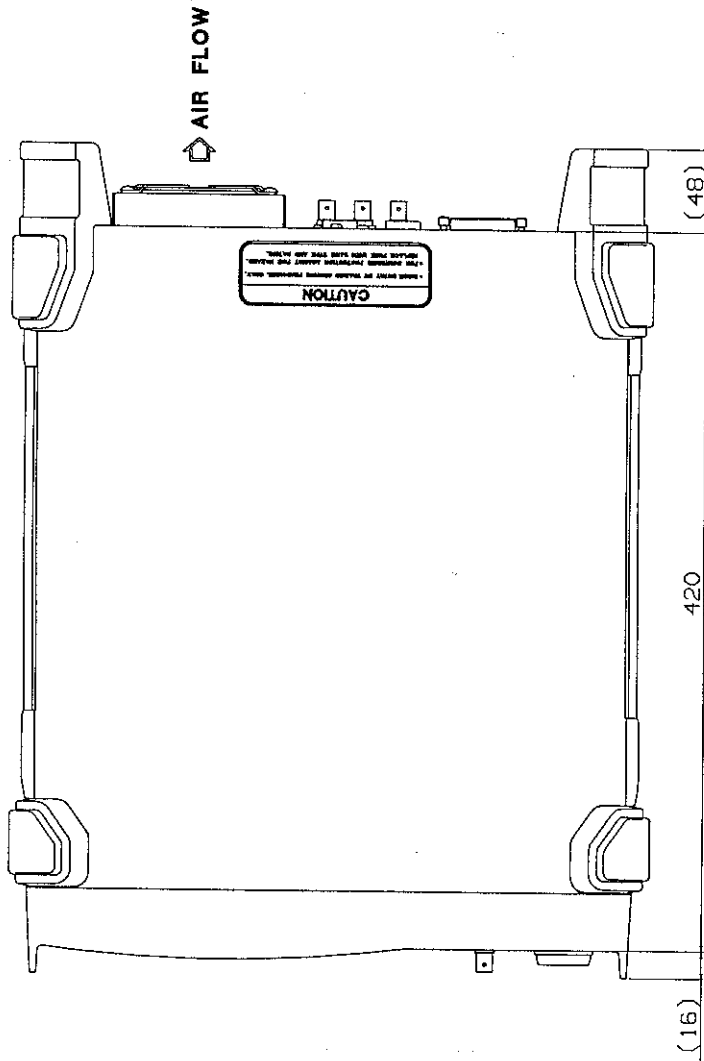
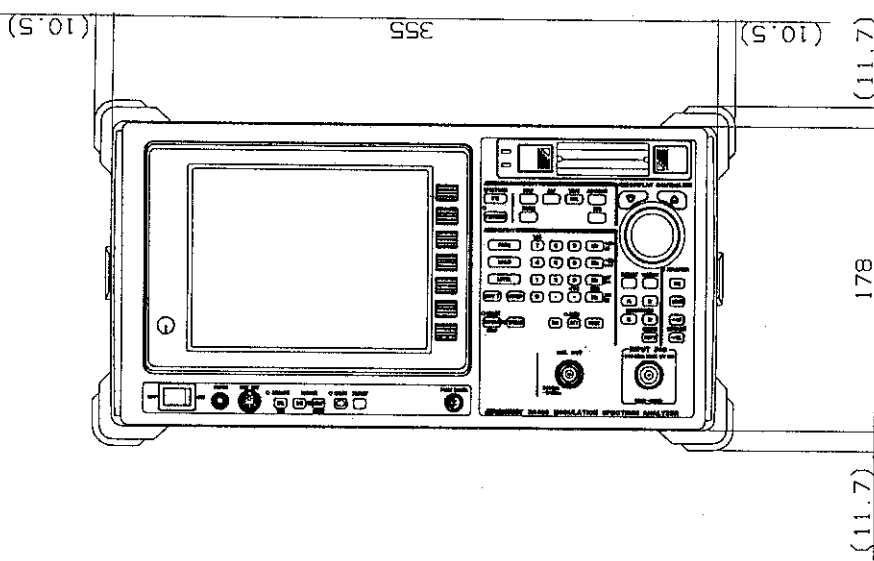

**DIMENSIONAL OUTLINE DRAWING**

Unit : mm

**CAUTION**

This drawing shows external dimensions of this instrument.

The difference in products and options used can cause a change in the appearance of the instrument.





## ALPHABETICAL INDEX

	<b>[Δ]</b>			
ΔY Setting	.....	7-33	Clear File menu	..... 7-91
	<b>[I]</b>		Clear Register menu	..... 7-87
1dB gain compression	.....	11-4	Command Syntax	..... 8-10
10MHz frequency reference			Condition register	..... 8-13
input/output	.....	11-8	Connectable Printer	..... 6-12
	<b>[2]</b>		Connecting GPIB	..... 8-3
21.4MHz IF output	.....	11-8	Connecting the Power Cable	.... 1-8
	<b>[4]</b>		Connecting to AC power source	.. 3-2
421MHz IF output	.....	11-8	Connection for power level	
	<b>[A]</b>		measurement	..... 3-11
ACP	.....	11-7	Contents of Storage to	
Amplitude Accuracy	.....	11-5	Memory Card	..... 6-3
Amplitude Condition for			Controller Functions	..... 8-6
Next Peak Search	.....	7-32	Convenient functions	
Amplitude Range	.....	11-3	MKR⇒CF, MKR⇒REF	..... 3-20
Amplitude resolution	.....	11-6	Correction Factor Function	.... 7-15
AM signal measured on time			Counter function	..... 7-57
domain	.....	5-5		
AM signal measured on frequency			<b>[D]</b>	
domain	.....	5-5	Data	..... 8-10
Analog Demodulation	.....	11-6	Data Formats	..... 8-11
Average display noise level	....	11-3	Data output format (talker)	.... 8-48
Average power of TRANSIENT			Data setting	..... 3-7
mode (after self-calibration)	....	11-7	dB Conversion Formulas	..... A-7
Averaging Mode	.....	7-19	Device Clear (DCL)	..... 8-7
	<b>[B]</b>		Dialog Box (Setting Menu),	
Back Up of the Memory Card	..	6-10	Error/Warning Message	..... 3-8
Block Diagram	.....	10-4	Digital modulation analysis	..... 11-6
	<b>[C]</b>		Dimensions	..... 11-9
Calibration	.....	3-10	Direct print	..... 11-9
Calibration signal accuracy			DISPLAY CONTROL Section	.... 2-5
(30 MHz)	.....	11-5	Display range	..... 11-3
Calibration signal output	.....	11-8	Dynamic Range	..... 3-22
Carrier frequency (fc)	.....	5-25		11-3
Case that abnormality occurs	....	1-10	<b>[E]</b>	
Center Frequency	.....	7-2	Enable register	..... 8-14
Changing the supply voltage	....	1-5	ENTRY Section	..... 2-4
Checking Power Requirements	..	1-5	Error No.	..... A-22
Cleaning	.....	1-9	Event Enable Register	..... 8-16
			Event register	..... 8-13
			Example of the program with	
			using the status byte	..... 8-60





<b>[P]</b>			
Panel keys and soft keys	3-5	Sample measurement of AM wave of low modulation degree and high modulation index	5-6
PASS/FAIL test	7-68	Sample measurement of approximately 200 MHz signal source	5-2
PDC	7-83	Sample measurement of FM wave of high modulation frequency and low m value	5-17
Peak power (Ppeak)	5-25	Sample measurement of FM wave of low modulation frequency	5-14
Peak Search	7-30	Sample measurement of the deviation of FM wave peak ( $\Delta f$ peak)	5-19
Peak Search Level Changing	7-33	Save File menu	7-88
PHS	7-82	Save function menu	7-85
Power level measurement by increased display resolution	3-13	Save Register menu	7-87
Power measurement function	7-77	Scale indication accuracy (After self calibration)	11-5
Power source	1-5	Select Item menu	7-92
	11-9	Selected Device Clear (SDC)	8-8
Power-on	3-3	Selecting AUTO of Coupled Functions	7-12
Program example of transient mode	8-64	Serial Polling Enable (SPE)	8-7
Program loader	11-9	Set condition of the display screen	6-3
Pulse quantization error	11-6	Setting	4-2
Pulse width ( $\tau$ )	5-25	Setting of GPIB address	8-4
Purser	8-9	Signal purity noise side band	11-2
		Signal Track Mode	7-30
<b>[R]</b>		Sound function	7-60
Rear panel	2-7	Space (space character)	8-10
Recall File menu	7-95	Specification of the Output Form	6-13
Recall function menu	7-96	Spectrum demodulation	11-6
Recall function menu	7-93	Spurious	11-7
Recall Register menu	7-94	Spurious measurement	7-59
Reference frequency	4-2	Spurious response	11-4
Reference Level	7-7	SRAM Card	A-21
Reference level range	11-3	Standard Event Register	8-21
Remote Enable (REN)	8-7	Standard Operation Status Register	8-18
Replacing the power fuse	1-6	Standard values	7-70
Resolution bandwidth switching error	11-6	Status Byte Register	8-18
Resolution bandwidth (3dB)	11-3	Status Register	8-13
Resolution Bandwidth (RBW)	7-10		
Responses to Interface Messages	8-7		
RF input	11-7		
RS-232 Remote Control Function	8-70		
<b>[S]</b>			
Sample measurement of AM wave of high modulation frequency and low modulation index	5-10		

Status Register Structure .....	8-13		
Status Register Types .....	8-14		
Step key and data knob .....	3-8		
Storage .....	1-9		
Sweep Key .....	7-42		
Sweep Mode Switching .....	7-48		
Sweep rate .....	3-22		
Sweep time .....	11-6		
Sweep Time .....	7-47		
Sweep Time Setup Menu .....	7-48		
System Functions .....	7-98		
<b>[X]</b>			
X axis output .....		11-8	
<b>[Y]</b>			
Y axis output .....		11-8	
<b>[Z]</b>			
Z axis output .....		11-8	
<b>[T]</b>			
Take Control (TCT) .....	8-8		
Temperature and humidity .....	11-9		
Ten-key and unit key .....	3-8		
The trace data and the table data .....	6-3		
Time Domain measurement .....	11-6		
Time domain wave form analyzing function .....	7-63		
To carry the device by hand .....	1-9		
Transmission velocity measurement .....	7-80		
Transportation .....	1-10		
Trigger .....	11-6		
<b>[U]</b>			
Units .....	8-12		
Usable Cards .....	A-21		
Usable Memory Card .....	6-2		
<b>[V]</b>			
Video bandwidth .....	11-3		
Video Bandwidth (VBW) .....	7-11		
Video output .....	11-8		
Voice output(Demodulation audio) .....	11-9		
<b>[W]</b>			
Warm up .....	1-11		
When PDC/NADC is set, .....	7-83		
When PHS is set, .....	7-82		
Writing multiple commands .....	8-10		









## ***Part 2***

### ***Applicable Instruments***

***R3465***

***R3272***

***R3263***

***R3463***



## **How to Use This Manual**

The following describes the structure of this manual.

- Part 1: Whole explanation for R3465
- Part 2: Performance test (Calibration)  
Applicable instruments are the R3465, R3272, R3263 and R3463.



## TABLE OF CONTENTS

1. PERFORMANCE TEST (CALIBRATION) .....	1-1
1.1 Introductory Description and UUT Performance Requirements .....	1-1
1.2 Measurement Standards and Support Test Equipment Performance Requirement .....	1-8
1.3 Preliminary Operations .....	1-11
1.4 Performance Test Process .....	1-12
1.4.1 Accuracy of Frequency Readout and Frequency Counter Marker ..	1-12
1.4.2 Frequency Reference Output Accuracy .....	1-15
1.4.3 Noise Sidebands .....	1-17
1.4.4 Frequency Span Accuracy .....	1-19
1.4.5 Resolution Bandwidth Accuracy and Selectivity .....	1-22
1.4.6 Resolution Bandwidth Switching Uncertainty .....	1-26
1.4.7 Displayed Average Noise Level .....	1-29
1.4.8 Gain Compression .....	1-37
1.4.9 Residual Response .....	1-41
1.4.10 Second Harmonic Distortion .....	1-44
1.4.11 Third Order Intermodulation Distortion .....	1-48
1.4.12 Image, Multiple and Out-of-Band Response .....	1-52
1.4.13 Frequency Response .....	1-60
1.4.14 IF Gain Uncertainty .....	1-74
1.4.15 Scale Fidelity .....	1-78
1.4.16 Input Attenuator Accuracy .....	1-84
1.4.17 Calibration Amplitude Accuracy .....	1-89
1.5 Checklist/Data Form .....	1-90



## LIST OF ILLUSTRATIONS

<u>No.</u>	<u>Title</u>	<u>Page</u>
1-1	Frequency Readout and Frequency Counter Marker Accuracy Test Setup . . . . .	1-12
1-2	Frequency Reference Accuracy Test Setup . . . . .	1-15
1-3	Noise Sidebands Test Setup . . . . .	1-17
1-4	Frequency Span Accuracy Test Setup . . . . .	1-19
1-5	Resolution Bandwidth Accuracy/Selectivity Setup . . . . .	1-22
1-6	Resolution BW Switching Uncertainty Test Setup . . . . .	1-26
1-7	Displayed Average Noise Test Setup . . . . .	1-30
1-8	Gain Compression Test Setup . . . . .	1-37
1-9	Residual Response Test Setup . . . . .	1-41
1-10	Second Harmonic Distortion Test Setup . . . . .	1-44
1-11	Third Order Intermodulation (<2 GHz) Test Setup . . . . .	1-48
1-12	Image, Multiple and Out-of-Band Response Test Setup . . . . .	1-52
1-13	Frequency Response Test Setup . . . . .	1-61
1-14	IF Gain Uncertainty Test Setup . . . . .	1-74
1-15	Scale Fidelity Test Setup . . . . .	1-78
1-16	Input Attenuator Switching Accuracy Test Setup . . . . .	1-84
1-17	Calibration Amplitude accuracy Test Setup . . . . .	1-89





## LIST OF TABLES

No.	Title	Page
1-1	UUT Performance Requirements .....	1-2
1-2	Measurement Standards (MS) Performance Requirements .....	1-9
1-3	Support Measuring & Test Equipment (M&TE) Performance Requirements .....	1-10
1-4	Frequency Readout Accuracy .....	1-14
1-5	Marker Frequency Counter Accuracy .....	1-14
1-6	Noise Sidebands .....	1-18
1-7	Frequency Span Accuracy .....	1-21
1-8	Resolution Bandwidth Accuracy .....	1-24
1-9	Resolution Bandwidth Selectivity .....	1-25
1-10	Resolution BW Switching Uncertainty .....	1-28
1-11	Displayed Average Noise Level (R3465) .....	1-34
	Displayed Average Noise Level (R3272) .....	1-35
	Displayed Average Noise Level (R3263/3463) .....	1-36
1-12	Gain Compression .....	1-40
1-13	Third Order Intermodulation Distortion .....	1-51
1-14	Image, Multiple and Out-of-Band Responses (R3272) .....	1-58
1-15	Image, Multiple and Out-of-Band Responses (R3465) .....	1-59
1-16	Image and Multiple Responses (R3263/3463) .....	1-59
1-17	Frequency Response(R3465/3272/3263/3463 : 9 kHz to 3.0 GHz Band) .....	1-68
1-18	Frequency Response (R3465 : 1.7 GHz to 7.0 GHz Band) .....	1-69
1-19	Frequency Response (R3272 : 3.0 GHz to 7.5 GHz Band) .....	1-70
1-20	Frequency Response (R3465 : 6.9 GHz to 8 GHz Band) .....	1-71
1-21	Frequency Response (R3272 : 7.4 GHz to 15.4 GHz Band) .....	1-71
1-22	Frequency Response (R3272 : 15.2 GHz to 23.3 GHz Band) .....	1-72
1-23	Frequency Response (R3272 : 23 GHz to 26.5 GHz Band) .....	1-73
1-24	IF Gain Error (RBW = 10 kHz, 1 dB/div. ) .....	1-76
1-25	IF Gain Error (RBW = 3 kHz, 1 dB/div.) .....	1-77
1-26	1 dB/div. Log Scale Fidelity (RBW = 3 kHz) .....	1-81
1-27	10 dB/div. Log Scale Fidelity (RBW = 3 kHz) .....	1-81
1-28	Linear Scale Fidelity (X1) .....	1-83
1-29	Input Attenuator Accuracy .....	1-87
1-30	Performance Test Record .....	1-90



## 1. PERFORMANCE TEST (CALIBRATION)

### 1.1 Introductory Description and UUT Performance Requirements

This procedure describes the performance test of the modulation spectrum analyzer R3465/3463 and the spectrum analyzer R3272/3263.

The unit being test will be referred to herein as the UUT (Unit-Under-Test).

UUT Environmental range : TEMP. 20°C to 30°C RH 85% or less  
UUT Warm-up/Stabilization period requirements : 60 minutes

**Spectrum Analyzer  
OPERATION MANUAL**

**1.1 Introductory Description and UUT Performance Requirements**

Table 1-1 UUT Performance Requirements (1 of 6)

Unit-Under-Test (UUT) Parameter/Function	Performance Specifications	Test Method
1. Frequency Readout Accuracy and Frequency Counter Marker Accuracy.	<p>Frequency Readout Accuracy:  <math>&lt; \pm [\text{Frequency reading} \times \text{Frequency Reference Accuracy}] + (\text{Span} \times \text{Span Accuracy}) + (0.15 \times \text{RES.BW}) + 10 \text{ Hz}]</math></p> <p>Span Accuracy:            Span <math>&gt; 5 \text{ MHz} \pm 4\%</math>            Span <math>\leq 5 \text{ MHz} \pm 1\%</math></p> <p>Marker Frequency Counter Accuracy:  <math>&lt; \pm [(\text{Marker Frequency} \times \text{Frequency Reference Accuracy}) + (5 \text{ Hz} \times \text{N}) + 1\text{LSD}]</math></p>	Signals are input from the SG where high-precision frequency standard is set as the reference frequency for measurement.
2. Frequency Reference Output Accuracy.	<p>Frequency: <math>&lt; 1 \times 10^{-7}/\text{year}</math>  <math>&lt; 2 \times 10^{-8}/\text{day}</math></p>	The frequency of CAL OUT signal locked to the internal 10 MHz reference is measured with the counter.
3. Noise Sidebands	<p><math>f \leq 3 \text{ GHz}</math>:            10 kHz offset <math>&lt; -100 \text{ dBc/Hz}</math>            100 kHz offset <math>&lt; -110 \text{ dBc/Hz}</math></p> <p><math>f &gt; 3 \text{ GHz}</math>:            10 kHz offset <math>&lt; (-98 + 20 \log N) \text{ dBc/Hz}</math>            100 kHz offset <math>&lt; (-108 + 20 \log N) \text{ dBc/Hz}</math></p>	Good noise sideband signals are input for measurement.
4. Frequency Span Accuracy	<p>Linear Span:  <math>&lt; \pm 4\%</math> (Span <math>&gt; 5 \text{ MHz}</math>)  <math>&lt; \pm 1\%</math> (Span <math>\leq 5 \text{ MHz}</math>)</p>	Signals at two frequencies according to each span are input to measure the difference between the frequencies.
5. Resolution Bandwidth Accuracy and Selectivity	<p>Range Accuracy:            300 Hz to 3 MHz, 5MHz; 1, 3, 10 sequence  <math>\pm 20\%</math> 1 kHz to 1 MHz  <math>\pm 30\%</math> 300 Hz, 3 MHz, 5MHz</p> <p>Selectivity :  <math>&lt; 15:1</math> 300 Hz to 5 MHz            Resolution Bandwidth 5 MHz (50 dB/3 dB)            Resolution Bandwidth 300 Hz to 3 MHz (60 dB/3 dB)</p>	CAL OUT signals are input for measurement.

**Spectrum Analyzer  
OPERATION MANUAL**

**1.1 Introductory Description and UUT Performance Requirements**

Table 1-1 UUT Performance Requirements (2 of 6)

Unit-Under-Test (UUT) Parameter/Function	Performance Specifications	Test Method
6. Resolution Bandwidth Switching Uncertainty	300 Hz to 3 MHz RBW: < ±0.3 dB (Reference to 300 kHz RBW) (3 × RBW ≥ Span)	CAL OUT signals are input for measurement.
7. Displayed Average Noise Level	(1 kHz res BW, 0 dB input attenuator, 1 Hz video filter) R3465: –70 dBm      10 kHz –80 dBm      100 kHz –{115 – 1.55f(GHz)} dBm 1 MHz to 3.0 GHz  –115 dBm     1.7 GHz to 7.0 GHz –115 dBm     6.9 GHz to 8.0 GHz  R3272: –70 dBm      10 kHz –80 dBm      100 kHz –{115 – 1.55f(GHz)} dBm 1 MHz to 3.1 GHz –110 dBm     3.0 GHz to 7.5 GHz –103 dBm     7.4 GHz to 15.4 GHz –96 dBm      15.2 GHz to 23.3 GHz –90 dBm      23 GHz to 26.5 GHz  R3263/3463: –70 dBm      10 kHz –80 dBm      100 kHz –{115 – 1.55f(GHz)} dBm 1 MHz to 3.0 GHz	No signal is input and average noise level at each frequency is measured.

*Spectrum Analyzer*  
**OPERATION MANUAL**

**1.1 Introductory Description and UUT Performance Requirements**

Table 1-1 UUT Performance Requirements (3 of 6)

Unit-Under-Test (UUT) Parameter/Function	Performance Specifications	Test Method																																	
8. Gain Compression (1 dB)	-5 dBm mixer input level > 10 MHz	Two signals are input simultaneously to measure the level at which one of the signals is lowered by 1 dB.																																	
9. Residual Response	(no signal at input, 0 dB input Attenuator, 50 Ω termination) R3465: <table style="margin-left: 40px; border-collapse: collapse;"> <tr> <td style="border-right: 1px solid black; padding: 2px 10px;"><math>&lt; -100</math> dBm</td> <td style="padding: 2px 10px;">1 MHz to 3.0 GHz</td> </tr> <tr> <td style="border-right: 1px solid black; padding: 2px 10px;"><math>&lt; -90</math> dBm</td> <td style="padding: 2px 10px;">300 kHz to 8.0 GHz</td> </tr> </table> R3272: <table style="margin-left: 40px; border-collapse: collapse;"> <tr> <td style="border-right: 1px solid black; padding: 2px 10px;"><math>&lt; -100</math> dBm</td> <td style="padding: 2px 10px;">1 MHz to 3.0 GHz</td> </tr> <tr> <td style="border-right: 1px solid black; padding: 2px 10px;"><math>&lt; -90</math> dBm</td> <td style="padding: 2px 10px;">300 kHz to 26.5 GHz</td> </tr> </table> R3263/3463: <table style="margin-left: 40px; border-collapse: collapse;"> <tr> <td style="border-right: 1px solid black; padding: 2px 10px;"><math>&lt; -100</math> dBm</td> <td style="padding: 2px 10px;">1 MHz to 3.0 GHz</td> </tr> <tr> <td style="border-right: 1px solid black; padding: 2px 10px;"><math>&lt; -90</math> dBm</td> <td style="padding: 2px 10px;">300 kHz to 3.0 GHz</td> </tr> </table>	$< -100$ dBm	1 MHz to 3.0 GHz	$< -90$ dBm	300 kHz to 8.0 GHz	$< -100$ dBm	1 MHz to 3.0 GHz	$< -90$ dBm	300 kHz to 26.5 GHz	$< -100$ dBm	1 MHz to 3.0 GHz	$< -90$ dBm	300 kHz to 3.0 GHz	No signal is input and the test is terminated at 50 Ω.																					
$< -100$ dBm	1 MHz to 3.0 GHz																																		
$< -90$ dBm	300 kHz to 8.0 GHz																																		
$< -100$ dBm	1 MHz to 3.0 GHz																																		
$< -90$ dBm	300 kHz to 26.5 GHz																																		
$< -100$ dBm	1 MHz to 3.0 GHz																																		
$< -90$ dBm	300 kHz to 3.0 GHz																																		
10. Second Harmonic Distortion	<table style="width: 100%; border-collapse: collapse;"> <tr> <td colspan="3">R3465:</td> </tr> <tr> <td style="border-right: 1px solid black; width: 30%;"></td> <td style="border-right: 1px solid black; width: 40%; text-align: center;">frequency range</td> <td style="width: 30%; text-align: center;">mixer level</td> </tr> <tr> <td style="border-right: 1px solid black;"><math>&lt; -70</math> dBc</td> <td style="border-right: 1px solid black;">10 MHz to 3.0 GHz</td> <td style="text-align: center;">-30 dBm</td> </tr> <tr> <td style="border-right: 1px solid black;"><math>&lt; -90</math> dBc</td> <td style="border-right: 1px solid black;">&gt; 1.7 GHz</td> <td style="text-align: center;">-10 dBm</td> </tr> <tr> <td colspan="3">R3272:</td> </tr> <tr> <td style="border-right: 1px solid black;"></td> <td style="border-right: 1px solid black; text-align: center;">frequency range</td> <td style="text-align: center;">mixer level</td> </tr> <tr> <td style="border-right: 1px solid black;"><math>&lt; -70</math> dBc</td> <td style="border-right: 1px solid black;">10 MHz to 3.0 GHz</td> <td style="text-align: center;">-30 dBm</td> </tr> <tr> <td style="border-right: 1px solid black;"><math>&lt; -100</math> dBc</td> <td style="border-right: 1px solid black;">&gt; 3.0 GHz</td> <td style="text-align: center;">-10 dBm</td> </tr> <tr> <td colspan="3">R3263/3463:</td> </tr> <tr> <td style="border-right: 1px solid black;"></td> <td style="border-right: 1px solid black; text-align: center;">frequency range</td> <td style="text-align: center;">mixer level</td> </tr> <tr> <td style="border-right: 1px solid black;"><math>&lt; -70</math> dBc</td> <td style="border-right: 1px solid black;">10 MHz to 3.0 GHz</td> <td style="text-align: center;">-30 dBm</td> </tr> </table>	R3465:				frequency range	mixer level	$< -70$ dBc	10 MHz to 3.0 GHz	-30 dBm	$< -90$ dBc	> 1.7 GHz	-10 dBm	R3272:				frequency range	mixer level	$< -70$ dBc	10 MHz to 3.0 GHz	-30 dBm	$< -100$ dBc	> 3.0 GHz	-10 dBm	R3263/3463:				frequency range	mixer level	$< -70$ dBc	10 MHz to 3.0 GHz	-30 dBm	The lowpass filter is connected to the SG output for measurement.
R3465:																																			
	frequency range	mixer level																																	
$< -70$ dBc	10 MHz to 3.0 GHz	-30 dBm																																	
$< -90$ dBc	> 1.7 GHz	-10 dBm																																	
R3272:																																			
	frequency range	mixer level																																	
$< -70$ dBc	10 MHz to 3.0 GHz	-30 dBm																																	
$< -100$ dBc	> 3.0 GHz	-10 dBm																																	
R3263/3463:																																			
	frequency range	mixer level																																	
$< -70$ dBc	10 MHz to 3.0 GHz	-30 dBm																																	

Table 1-1 UUT Performance Requirements (4 of 6)

Unit-Under-Test (UUT) Parameter/Function	Performance Specifications	Test Method		
11. Third Order Intermodulation Distortion	Separation: 12.5 kHz Resolution bandwidth: 300 Hz Video bandwidth: 3 Hz or less	Two neighboring signals are input simultaneously for measurement.		
	R3465:			
	frequency range		mixer level	
	< -75 dBc		10 MHz to 3.0 GHz	-30 dBm
	< -75 dBc		> 1.7 GHz	-30 dBm
	R3272:			
	frequency range		mixer level	
	< -75 dBc		10 MHz to 3.0 GHz	-30 dBm
	< -75 dBc		> 3.0 GHz	-30 dBm
	R3263/3463:			
	frequency range		mixer level	
	< -75 dBc		10 MHz to 3.0 GHz	-30 dBm
12. Image, Multiple, Out of Band Response	R3465: < -70 dBc (10 MHz to 8 GHz)	Signals allowing image, multiple and out of band response as against the center frequency are input for measurement.		
	R3272: < -70 dBc (10 MHz to 18 GHz) < -60 dBc (10 MHz to 23 GHz) < -50 dBc (10 MHz to 26.5 GHz)			
	R3263/3463: < -70 dBc (10 MHz to 3 GHz)			

**Spectrum Analyzer  
OPERATION MANUAL**

**1.1 Introductory Description and UUT Performance Requirements**

Table 1-1 UUT Performance Requirements (5 of 6)

Unit-Under-Test (UUT) Parameter/Function	Performance Specifications	Test Method
13. Frequency Response	10 dB input attenuator R3465: ± 1.5 dB   9 kHz to 3.0 GHz ± 1.0 dB   50 MHz to 3.0 GHz ± 1.5 dB   1.7 GHz to 7.0 GHz ± 1.5 dB   6.9 GHz to 8 GHz Frequency Response Referenced to CAL Signal: ± 3 dB    9 kHz to 8 GHz R3272: ± 1.5 dB   9 kHz to 3.1 GHz ± 1.0 dB   50 MHz to 3.1 GHz ± 1.5 dB   3.0 GHz to 7.5 GHz ± 3.5 dB   7.4 GHz to 15.4 GHz ± 4.0 dB   15.4 GHz to 23.3 GHz ± 4.0 dB   23 GHz to 26.5 GHz Frequency Response Referenced to CAL Signal: ± 5 dB    9 kHz to 26.5 GHz R3263/3463: ± 1.5 dB   9 kHz to 3.0 GHz ± 1.0 dB   50 MHz to 3.0 GHz Frequency Response Referenced to CAL Signal: ± 2 dB    9 kHz to 3.0 GHz	The signal level of SG at a certain level on the screen is measured at each frequency with the power meter.
14. IF Gain Uncertainty	(after automatic calibration) ± 0.5 dB   0 dBm to -50 dBm	The REF level is raised while lowering the signal level with the SG to measure the error.
15. Scale Fidelity	(after automatic calibration) Log: ± 0.2 dB/1 dB, ± 1 dB/10 dB, ± 1.5 dB/80 dB  Linear: ± 15% of reference level (within 8 Div)	Input signal is lowered with the SG for measurement.



Table 1-1 UUT Performance Requirements (6 of 6)

Unit-Under-Test (UUT) Parameter/Function	Performance Specifications	Test Method
16. Input Attenuator Accuracy	<p>(20 dB to 70 dB settings referenced to 10 dB)</p> <p>R3465: ± 1.1 dB/10 dB step, 2.0 dB max, 9 kHz to 8 GHz</p> <p>R3272: ± 1.1 dB/10 dB step, 2.0 dB max, 9 kHz to 12.4 GHz ± 1.3 dB/10 dB step, 2.5 dB max, 12.4 GHz to 18 GHz ± 1.8 dB/10 dB step, 3.5 dB max 18 GHz to 26.5 GHz</p> <p>R3263/3463: ± 1.1 dB/10 dB step, 2.0 dB max, 9 kHz to 3.0 GHz</p>	Signal at a frequency is input and measured with the internal attenuator.
17. Calibration Amplitude Accuracy	Amplitude: - 10 dBm ± 0.3 dB	CAL OUT signals are measured with the power meter.

## 1.2 Measurement Standards and Support Test Equipment Performance

### Requirement

Minimum-Use-Specifications (MUS) are the calculated minimum performance specifications criteria needed for the Measurement Standards (MS) and support M&TE to be used for the comparison measurements required in the Test Procedure (TP) process.

The MUS is developed through uncertainty analysis and is calculated through assignment of a defines and documented uncertainty/accuracy ratio or margin between the specified tolerances of the UUT and the capability (uncertainty specification) required of the measurement standards system. MUS is required to assist a measurement specialist in the evaluation of existing or selection of alternate measurement standards equipment.

The uncertainty/accuracy ratio applied in this TP is 10:1 and any exception to that is indicated in Section 1.1.

**CAUTION**

The instructions in this TP relate specifically to the equipment and conditions listed in Section 1.2. If other equipment is substituted, the information and instructions must be interpreted and revised accordingly.

MS and SM&TE Environmental Range : Temperature : 18°C to 28°C  
: Relative Humidity : 30% to 70%

MS and SM&TE Warm-up/Stabilization Period Requirements : 60 minutes

**Spectrum Analyzer  
OPERATION MANUAL**

**1.2 Measurement Standards and Support Test Equipment Performance Requirement**

Table 1-2 Measurement Standards (MS) Performance Requirements

Equipment Generic Name (Quality)	Minimum-Use-Specifications	Note
Frequency Standard	Output Frequency : 10 MHz Stability : $5 \times 10^{-10}$ /day Output Impedance : about 50 $\Omega$ Output Voltage : 1 Vpp or more	
Synthesized Sweeper	Frequency Range : 10 MHz to 18 GHz Frequency Accuracy (CW): $3 \times 10^{-8}$ /day Power Level Range : -20 dBm to +15 dBm	SG1
Frequency Counter	Frequency Range : 10 Hz to 120 MHz Gate Time : 10s Number of Digits Displayed : 8 digits Input Voltage Range : 25 mVrms to 500 mVrms	
Synthesized Signal Generator	Frequency Range : 10 MHz to 4 GHz Residual SSB Phase Noise: 1 kHz offset < -115 dBc/Hz 10 kHz offset < -125 dBc/Hz 100 kHz offset < -130 dBc/Hz Power Level Range: -20 dBm to +10 dBm	SG2
Power Meter	Accuracy : $\pm 0.02$ dB (dB Relative Mode)	
Power Sensor	Frequency Range : 50 MHz to 26.5 GHz Power Range : 1 $\mu$ W to 100 mW Maximum SWR : 1.25 (26.5 GHz)	Sensor 1
	Frequency Range : 10 MHz to 18 GHz Power Range : 1 $\mu$ W to 10 mW	Sensor 2
Synthesized Sweeper	Frequency Range : 10MHz to 26.5 GHz Power Level Range: -20 dBm to +10 dBm	SG3
Synthesized Level Generator	Frequency Range :30 MHz Power Level Range :-60dBm to +10dBm Absolute Level Accuracy : $\pm 0.2$ dB	SG4

*Spectrum Analyzer*  
**OPERATION MANUAL**

**1.2 Measurement Standards and Support Test Equipment Performance Requirement**

Table 1-3 Support Measuring & Test Equipment (M&TE) Performance Requirements

Equipment Generic Name (Quality)	Minimum-Use-Specifications	Note
Adapter	Type N(m) to BNC(f)	
	Type N(m) to SMA(f)	
	SMA(m) to SMA(m)	
	Type N(f) to BNC(m)	
50 $\Omega$ Termination	SMA	
20dB Fixed, 3dB Fixed Attenuator	Frequency Range : DC to 26.5 GHz Connector : SMA(m), SMA(f)	
Power Splitter	Frequency Range : 10 MHz to 26.5 GHz Insertion Loss : 6 dB (nominal)	
Low-pass Filter	Cutoff Frequency : 2.2 GHz Rejection at 3 GHz : > 40 dB Rejection at 3.8 GHz: > 80 dB	
Power Divider	Frequency Range : 2 MHz to 2 GHz Isolation : > 20 dB	Divider 1
	Frequency Range : 2 GHz to 4 GHz Isolation : > 20 dB	Divider 2
Cable	Frequency Range : DC to 26.5 GHz Maximum SWR : < 1.45 GHz at 26.5 GHz Length : about 70 cm Connector : SMA(m) both ends	
	Length : 150 cm Connector : BNC(m) both ends	
	Length : 10 cm Connector : BNC(m) both ends	

### 1.3 Preliminary Operations

**WARNING**

Always make sure spectrum analyzer's power supply cord is plugged into a 3-hole grounded outlet or 2-hole outlet with grounded adapter. You can be fatally shocked if you fail to follow this rule.

Do not touch live circuits when calibrating instrument.

- (1) Review this entire procedure before starting calibration procedure.
- (2) Always confirm that the POWER switch is OFF before connecting the power cable to the AC line.

## 1.4 Performance Test Process

### 1.4.1 Accuracy of Frequency Readout and Frequency Counter Marker

- SPECIFICATION

Frequency Readout Accuracy <  $\pm [( \text{Frequency reading} \times \text{Frequency Reference Accuracy} ) + ( \text{Span} \times \text{Span Accuracy} ) + ( 0.15 \times \text{RES.BW} ) + 10 \text{ Hz}]$

Span Accuracy:           Span > 5MHz      $\pm 4\%$   
                                   Span  $\leq$  5MHz      $\pm 1\%$

Marker Frequency Counter Accuracy <  $\pm [ ( \text{Marker Frequency} \times \text{Frequency Reference Accuracy} ) + ( 5 \text{ Hz} \times N ) + 1 \text{ LSD}]$

- RELATED ADJUSTMENT

YTO Adjustment

10 MHz Frequency Reference Adjustment

- DESCRIPTION

The accuracy of the R3465/3272/3263/3463 frequency readout and frequency counter marker is tested with an input signal of known frequency.

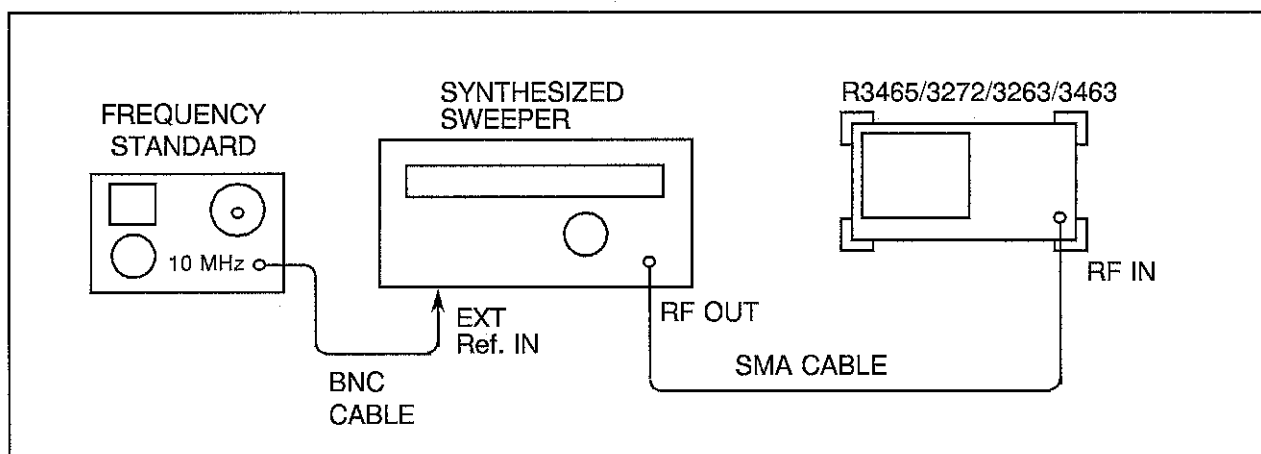

Figure 1-1 Frequency Readout and Frequency Counter Marker Accuracy Test Setup

- EQUIPMENT

Frequency Standard

Synthesized Sweeper (SG3)

Cables:

SMA, 70 cm

BNC, 150 cm

● PROCEDURE

(1) Connect the equipment as shown in Figure 1-1

[Frequency Readout Accuracy]

(2) Press the INSTRUMENT PRESET key on the SG3. Set the SG3 controls as follows:

CW .....	1.5 GHz
Power Level .....	- 10 dBm
Frequency Reference .....	EXT (Rear Panel)

(3) On the R3465/3272/3263/3463, press the SHIFT and PRESET keys and set the controls as follows:

Center Frequency .....	1.5 GHz
Span .....	5 MHz

(4) For the R3465, press FREQ, more 1/2 and Preselector  
1.7G 3.0G keys to set the preselector to 3.0 GHz.

(5) On the R3465/3272/3263/3463, press the SRCH key. Record the MKR frequency on Table 1-4 as the Actual Marker Reading. The reading should be within the limits shown.

(6) Repeat step (5) for all the frequency and span combinations listed in Table 1-4. Peak the R3465/3272 preselector for and set the Analyzer and the SG3 CW key to frequencies of 5 GHz and above.

[Frequency Counter Marker Accuracy]

(7) Set the SPAN key of the R3465/3272/3263/3463 to 5 MHz.

Press the CW, Counter, Preselector and Counter  
ON OFF keys to set the counter to ON.

(8) Key in the SG3 CW frequencies and the R3465/3272/3263/3463 center as indicated in Table 1-5. For each pair of settings, press the SRCH key and record the MKR frequency at each point in Table 1-5. The marker readings should be within the limits shown.

**Spectrum Analyzer  
OPERATION MANUAL**

**1.4 Performance Test Process**

Table 1-4 Frequency Readout Accuracy

SG3 Frequency (GHz)	R3465/3272/3263/3463		Δ Marker Reading		
	Span	Center Frequency	Min. (GHz)	Actual (GHz)	Max. (GHz)
1.5	1 MHz	1.5 GHz	1.499988		1.500012
1.5	10 MHz	1.5 GHz	1.49958		1.50042
1.5	50 MHz	1.5 GHz	1.49784		1.50216
1.5	100 MHz	1.5 GHz	1.4958		1.5042
1.5	2 GHz	1.5 GHz	1.419		1.581
< R3465/3272 ONLY >					
5	1 MHz	5 GHz	4.999987		5.000013
5	10 MHz	5 GHz	4.99958		5.00042
5	50 MHz	5 GHz	4.99784		5.00216
5	100 MHz	5 GHz	4.9958		5.0042
5	2 GHz	5 GHz	4.919		5.081
< R3272 ONLY >					
11	1 MHz	11 GHz	10.999987		11.000013
11	10 MHz	11 GHz	10.99958		11.00042
11	50 MHz	11 GHz	10.99784		11.00216
11	100 MHz	11 GHz	10.9958		11.0042
11	2 GHz	11 GHz	10.919		11.081
18	1 MHz	18 GHz	17.999986		18.000014
18	10 MHz	18 GHz	17.99958		18.00042
18	50 MHz	18 GHz	17.99784		18.00216
18	100 MHz	18 GHz	17.9958		18.0042
18	2 GHz	18 GHz	17.919		18.081

Table 1-5 Marker Frequency Counter Accuracy

SG3 Frequency (GHz)	R3465/3272/3263/3463 Center Frequency (GHz)	Marker Frequency		
		Min.(GHz)	Actual(GHz)	Max.(GHz)
1.5	1.5	1.499999844		1.500000156
< R3465/3272 ONLY >				
5	5	4.999999494		5.000000506
< R3272 ONLY >				
11	11	10.999998889		11.000001111
18	18	17.999998184		18.000001816



### 1.4.2 Frequency Reference Output Accuracy

- SPECIFICATION

Frequency:  $<1 \times 10^{-7}$ /year,  $<2 \times 10^{-8}$ /day

- RELATED ADJUSTMENT

Frequency Reference Adjustment

- DESCRIPTION

The 10 MHz reference signal is measured for frequency accuracy by measuring the frequency of the 30 MHz CAL OUTPUT signal. The CAL OUTPUT signal is referenced to the 10 MHz reference.

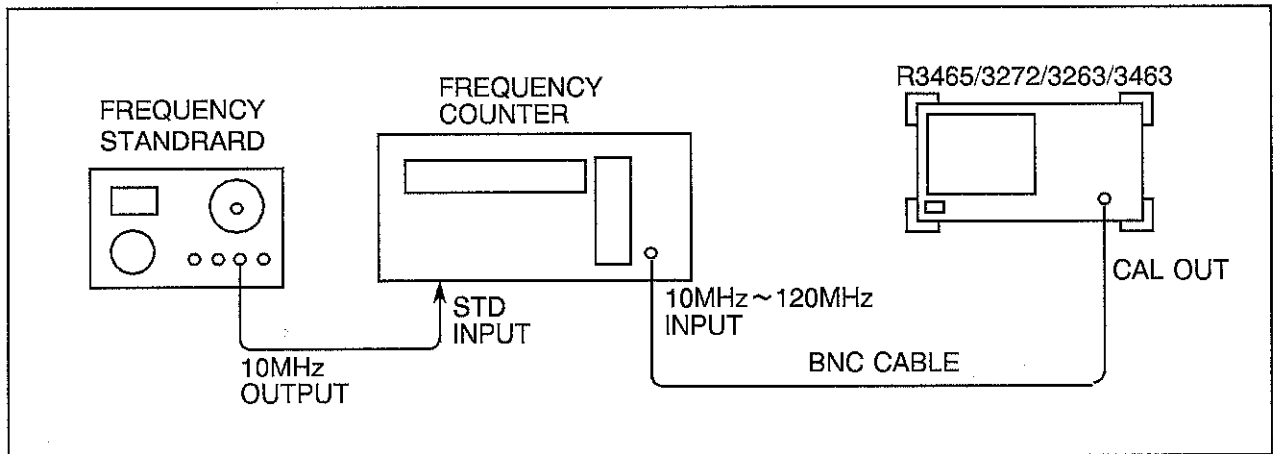

Figure 1-2 Frequency Reference Accuracy Test Setup

- EQUIPMENT

Frequency Counter  
Frequency Standard



Cables:

BNC, 150 cm (Two required)

● PROCEDURE

- (1) Connect the equipment as shown in Figure 1-2.
- (2) Set the Frequency counter controls as follows:

FREQUENCY STD SWITCH (Rear Panel) ..... EXT  
GATE TIME ..... 10 sec

- (3) Press the  and  keys on the R3465/3272/3263/3463.

CAUTION

Before starting this measurement, perform warm-up operation of the R3465/3272/3263/3463 for more than 30 minutes. If the frequency reference of the R3465/3272/3263/3463 is set to EXT, set it to INT or perform 15-minute warm-up operation after instrument preset.

- (4) Wait for the frequency counter to settle down.
- (5) Read the frequency counter display. The frequency should be within the following limits:

$$(2)*9.9999970 \leq \text{_____} \leq (2)*0.0000030$$

\*: The counter can display only eight digits.

### 1.4.3 Noise Sidebands

- SPECIFICATION

Noise Sidebands:

Offset	$f \leq 3.0$ GHz	$f > 3.0$ GHz
10 kHz	$< -100$ dBc/Hz	$< (-98 + 20 \log N)$ dBc/Hz
100 kHz	$< -110$ dBc/Hz	$< (-108 + 20 \log N)$ dBc/Hz

- RELATED ADJUSTMENT

There is no related adjustment procedure for this performance test.

- DESCRIPTION

The noise sidebands of a 1.5 GHz and 3.5 GHz,  $-10$  dBm signal are measured at an offset of 10 kHz and 100 kHz from the carrier.

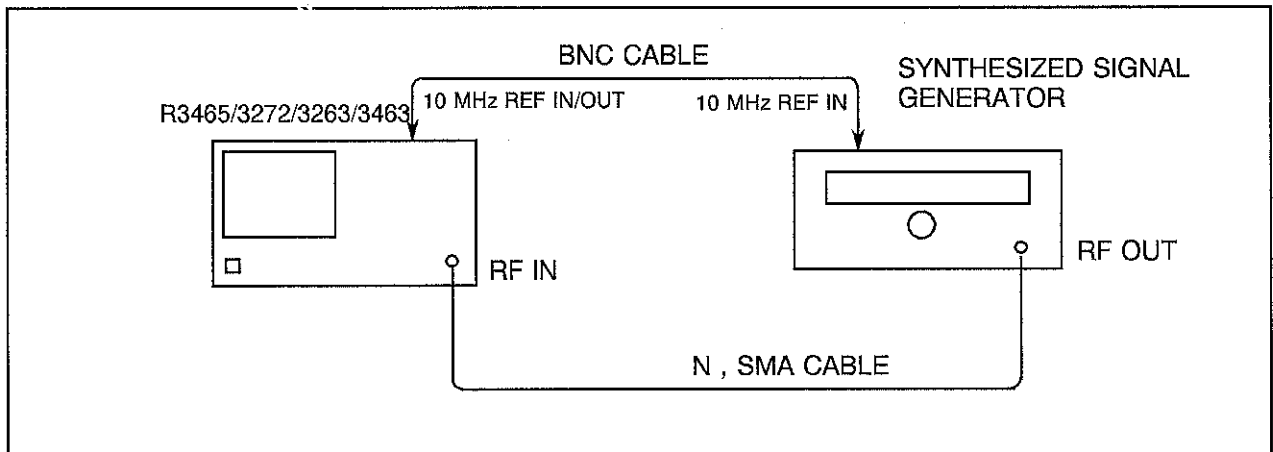

Figure 1-3 Noise Sidebands Test Setup

- EQUIPMENT: Synthesized Signal Generator (SG2)

Cables:           BNC, 150 cm  
                      SMA, 70cm

● **PROCEDURE**

- (1) Connect the equipment as shown in Figure 1-3.
- (2) Set the Signal Generator (SG2) controls as follows:

Frequency ..... 1.5 GHz & 3.5 GHz  
 CW Output ..... -5 dBm

- (3) Press the SHIFT and PRESET keys on the R3465/3272/3263/3463.  
 Press FREQ, 1, ., 5 and GHz keys.

Since the measurement is made for each of 10 kHz and 100 kHz offset frequency, set the span frequency to 2.5 times each offset frequency, or 25 kHz and 250 kHz. Keep other settings unchanged.

- (4) Operate keys on the R3465/3272/3263/3463 as follows to measure noise sidebands of each offset frequency. The measurement procedure for 100 kHz offset frequency is explained here, and the procedure is applicable for 10 kHz offset frequency.

Set the span corresponding to offset.

Press the →RL key.  
 Press the CW, more 1/2, NOISE/  
XHz and dBc/Hz keys.

Press 1, 0, 0 and kHz keys to set each offset frequency.

Press the reference level by 20 dB and perform averaging for about 20 samples. After averaging, read the marker level and write it down in Table 1-6.

For the R3465/3272, measure noise sidebands with the center frequency at 3.5 GHz, and Table 1-6 is completed.

Table 1-6 Noise Sidebands

Offset (kHz)	CF 1.5 GHz		CF 3.5 GHz	
	Actual (dBc/Hz)	Max. (dBc/Hz)	Actual (dBc/Hz)	Max. (dBc/Hz)
10		-100		-98
100		-110		-108

#### 1.4.4 Frequency Span Accuracy

- SPECIFICATION
  - <  $\pm 4\%$  of actual frequency separation (SPAN > 5 MHz)
  - <  $\pm 1\%$  of actual frequency separation (SPAN  $\leq 5$  MHz)
- RELATED ADJUSTMENT
  - Span adjustment.
- DESCRIPTION

Set the signal frequency twice with the synthesized sweeper and measure the difference between signal frequencies with the analyzer.

Check the span accuracy using the signal frequency difference measured with the  $\Delta$  MARKER function.

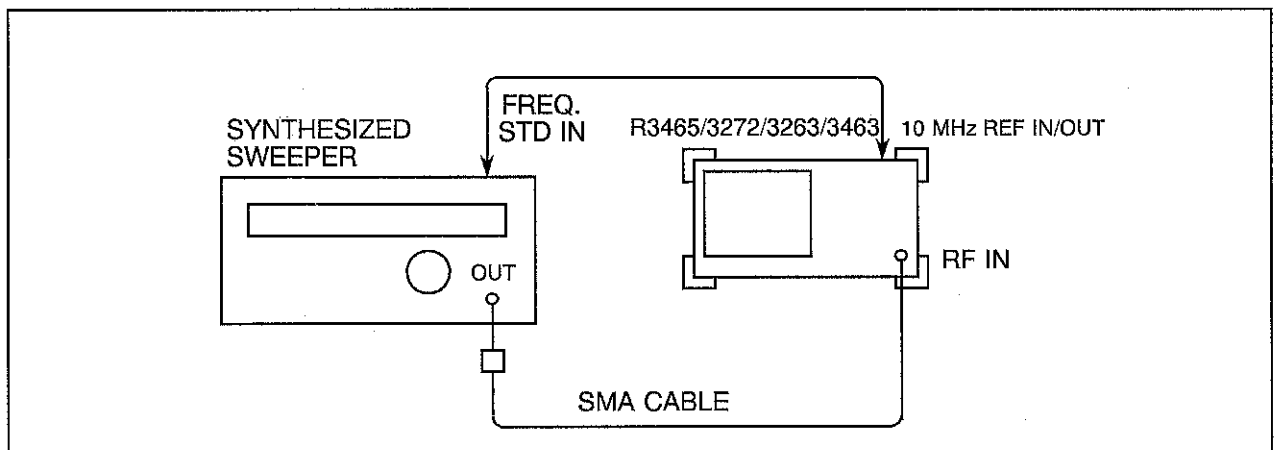

Figure 1-4 Frequency Span Accuracy Test Setup

- EQUIPMENT
  - Synthesized Sweeper (SG3)
- Cables:
  - SMA, 70 cm
  - BNC, 150 cm

● PROCEDURE

(1) Connect the equipment as shown in Figure 1-4.

(2) Set the SG3 controls as follows:

CW .....	1.498 GHz
Power Level .....	-5 dBm
Frequency STD Switch (Rear Panel) .....	EXT

(3) On the R3465/3272/3263/3463, press the SHIFT, PRESET key and set the R3465/3272/3263/3463 controls as follows:

Center Frequency .....	1.5 GHz
Span .....	5 MHz

(4) On the R3465/3272/3263/3463, press the SINGLE, SRCH, MARKER ON and Delta MKR keys.

(5) Set the SG3 controls as follows:

CW .....	1.502 GHz
----------	-----------

(6) On the R3465/3272/3263/3463, press the SINGLE and SRCH keys. Record the  $\Delta$  MARKER frequency reading as the Actual  $\Delta$  MARKER Reading in Table 1-7.

The reading should be within the limits shown.

(7) On the R3465/3272/3263/3463, press the MARKER ON and Normal MKR keys.

(8) Set the frequency of the SG3, the center frequency and span of the R3465/3272/3263/3463 as shown in Table 1-7, and repeat steps (5) through (8).

Table 1-7 Frequency Span Accuracy

SG3 1st Frequency	SG3 2nd Frequency	R3465/3272/3263/3463		△ Marker Reading		
		Center Frequency	Span Setting	Min.	Actual	Max.
1.498 GHz	1.502 GHz	1.5 GHz	5 MHz	3.96 MHz		4.04 MHz
1.498 GHz	1.502 GHz	1.5 GHz	5.01 MHz	3.847 MHz		4.169 MHz
1.484 GHz	1.516 GHz	1.5 GHz	40 MHz	30.72 MHz		33.28 MHz
1.34 GHz	1.66 GHz	1.5 GHz	400 MHz	307.2 MHz		332.8 MHz
< R3465/3272 ONLY >						
2.4 GHz	5.6 GHz	4.0 GHz	4 GHz	3.072 GHz		3.328 GHz
0.8 GHz	7.2 GHz	4.0 GHz	8 GHz	6.144 GHz		6.656 GHz
< R3272 ONLY >						
6 GHz	14 GHz	10 GHz	10 GHz	7.68 GHz		8.32 GHz
2 GHz	18 GHz	10 GHz	19 GHz	15.36 GHz		16.64 GHz

### 1.4.5 Resolution Bandwidth Accuracy and Selectivity

- SPECIFICATION

Range:	300 Hz to 3 MHz, 5 MHz; 1, 3, 10 Sequence
Accuracy:	$\pm 20\%$ (Resolution Bandwidth 1 kHz to 1 MHz) $\pm 30\%$ (Resolution Bandwidth 300 Hz, 3 MHz, 5 MHz)
Selectivity:	$< 15:1$ (300 Hz to 5 MHz) (Resolution Bandwidth 5 MHz      50dB BW/3 dB BW) (Resolution Bandwidth 300 Hz to 3 MHz      60dB BW/3 dB BW)

- RELATED ADJUSTMENT

- DESCRIPTION

This test measures the resolution bandwidth accuracy and selectivity. The 60 dB bandwidth is then determined and the results used to calculate the selectivity for each bandwidth.

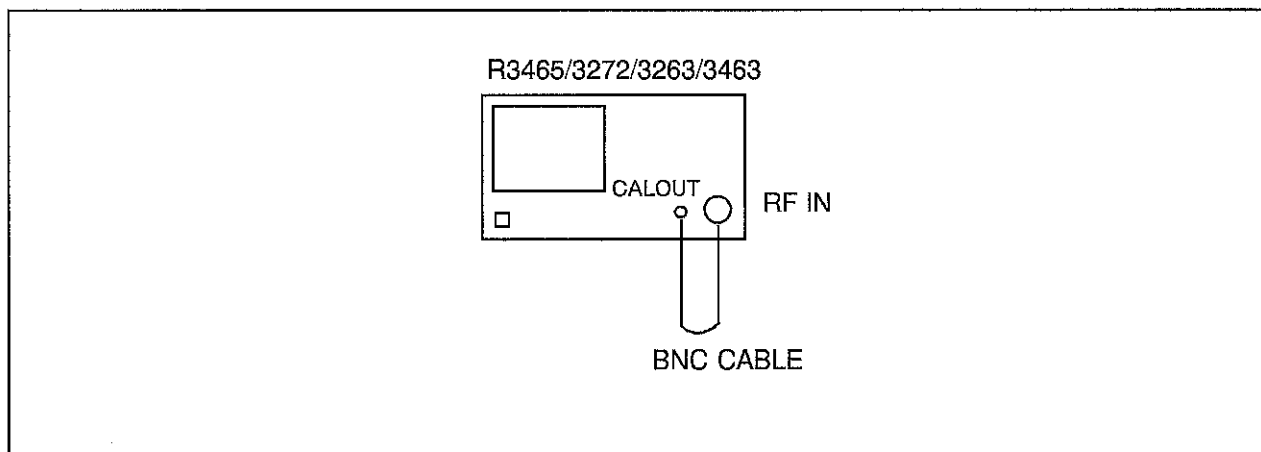

Figure 1-5 Resolution Bandwidth Accuracy/Selectivity Setup

- EQUIPMENT

Adapters :

Typed N(m) to BNC (f)

Cable:

BNC 10 cm



● PROCEDURE

[Resolution Bandwidth Accuracy]

(1) Connect the R3465/3272/3263/3463 CALOUT to the RF IN as shown in Figure 1-5.

(2) Press SHIFT , PRESET keys and set the controls as follows:

Press FREQ , 3 , 0 and MHz keys.

Press SPAN , 1 , 5 and MHz keys.

Press LEVEL , 5 , -dBm , dB/div and 1dB/DIV keys.

Press BW , RBW , AUTO , MNL , 5 and MHz keys.

Press FORMAT , Trace Detector and Posi keys.

(3) Press SINGLE key, and wait for a new sweep to finish.

(4) Press SRCH , MARKER , ON , more 1/3 , X dB DOWN , 3 and dB keys.

(5) Record the marker frequency in Tables 1-8 and 1-9 as actual 3 dB bandwidth.

(6) Change the RBW and span frequency as shown in Table 1-8, and repeat steps (3), (4) and (5) for remaining RBWs.

[Resolution Bandwidth Selectivity]

(7) Press SHIFT , PRESET and set the controls as follows:

Press FREQ , 3 , 0 and MHz keys.

Press SPAN , 2 , 5 and MHz keys.

Press BW , RBW , AUTO , MNL , 5 and MHz keys.

Press VBW , AUTO , MNL , 1 , 0 and kHz keys.

Press FORMAT , Trace Detector and Posi keys.

- (8) Press SINGLE key.
- (9) Press SRCH , MARKER  
ON , more 1/3 , x dB  
DOWN , 5 , 0 and dB keys.
- (10) Record the marker frequency in Table 1-9 as actual 60 dB bandwidth.
- (11) Divide the 60 dB bandwidth by the 3 dB bandwidth and record as the Actual Resolution Bandwidth Selectivity in Table 1-9.
- (12) Change the RBW and span frequency as shown in Table 1-9, and repeat steps (8) through (11) for remaining RBWs.

Set VBW to AUTO if RBW is 10kHz or below.

Table 1-8 Resolution Bandwidth Accuracy

Resolution Bandwidth Setting	Frequency Span Setting	3dB Bandwidth		
		Min.	Actual	Max.
5 MHz	10 MHz	3.50 MHz		6.5 MHz
3 MHz	5 MHz	2.1 MHz		3.9 MHz
1 MHz	2 MHz	800 kHz		1.2 MHz
300 kHz	500 kHz	240 kHz		360 kHz
100 kHz	200 kHz	80 kHz		120 kHz
30 kHz	50 kHz	24 kHz		36 kHz
10 kHz	20 kHz	8.0 kHz		12.0 kHz
3 kHz	5 kHz	2.4 kHz		3.6 kHz
1 kHz	2 kHz	800 Hz		1200 Hz
300 Hz	2 kHz	210 Hz		390 Hz

Table 1-9 Resolution Bandwidth Selectivity

Resolution Bandwidth Setting	Frequency Span Setting	60 dB Bandwidth	3 dB Bandwidth	Selectivity	
				Actual	Max.
*1) 5 MHz	25 MHz				
3 MHz	25 MHz				15
1 MHz	20 MHz				15
300 kHz	5 MHz				15
100 kHz	1 MHz				15
30 kHz	500 kHz				15
10 kHz	200 kHz				15
3 kHz	50 kHz				15
1 kHz	20 kHz				15
300 Hz	5 kHz				15

\*1: RBW 5MHz Selectivity = 50 dB/3 dB

### 1.4.6 Resolution Bandwidth Switching Uncertainty

- SPECIFICATION

300 Hz to 3 MHz RES BW:  $< \pm 0.3$  dB (referred to 300 kHz RBW)

- RELATED ADJUSTMENT

There is no related adjustment procedure for this performance test.

- DESCRIPTION

This test utilizes the CALOUT signal for measuring the switching uncertainty between resolution bandwidths. At each resolution bandwidth setting, the displayed amplitude variation of the signal is measured. All measurements are referenced to the 300 kHz bandwidth.

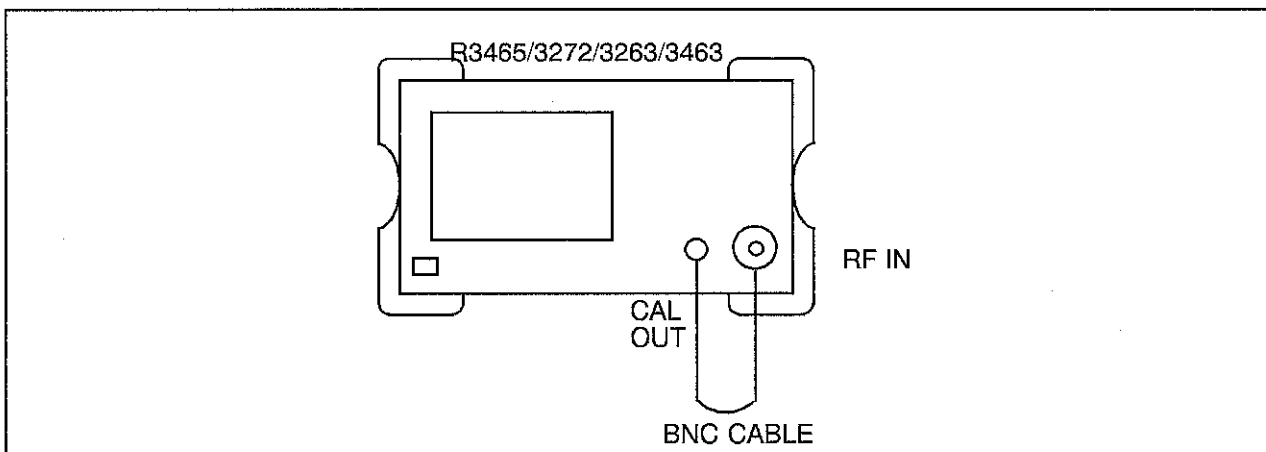

Figure 1-6 Resolution BW Switching Uncertainty Test Setup

- EQUIPMENT

Adapters :

Typed N(m) to BNC (f)

Cable:

BNC 10 cm

● PROCEDURE

(1) Connect the R3465/3272/3263/3463 CALOUT to the RF IN as shown in Figure 1-6.

(2) Press the SHIFT , PRESET , CAL , 7 , EACH  
ITEM and RBW  
SWITCH keys.

Wait for the "Calibration in progress" message to disappear.

Set the instrument controls as follows:

Center Frequency .....	30 MHz
Span .....	500 kHz
Ref Level .....	-5 dBm
RBW .....	300 kHz
Sweep Mode .....	SINGLE
dB/Div .....	1 dB/Div
Trace Detector .....	Posi

(3) Press the SINGLE , SRCH , ON , Delta MKR and FIXED MKR  
ON OFF keys to set the

MKR to ON.

(4) Set the frequency span and RBW to the values listed in the second entry of Table 1-10 (Span 5 MHz, RBW 3 MHz).

(5) Press the SINGLE , SRCH keys.

Record the  $\Delta$  MARKER amplitude in the Actual  $\Delta$  MARKER Reading column of Table 1-10. The MARKER reading should be within the limit shown.

(6) Repeat steps (4) and (5) for each set of frequency span and RBW settings in Table 1-10.

Table 1-10 Resolution BW Switching Uncertainty

R3465/3272/3263/3463		$\Delta$ Marker Reading		
Span	RBW	Min. (dB)	Actual	Max. (dB)
500 kHz	300 kHz	0	0 (Ref.)	0
5 MHz	3 MHz	-0.3		+0.3
2 MHz	1 MHz	-0.3		+0.3
200 kHz	100 kHz	-0.3		+0.3
50 kHz	30 kHz	-0.3		+0.3
20 kHz	10 kHz	-0.3		+0.3
5 kHz	3 kHz	-0.3		+0.3
2 kHz	1 kHz	-0.3		+0.3
2 kHz	300 Hz	-0.3		+0.3

### 1.4.7 Displayed Average Noise Level

- **SPECIFICATIONS**

Displayed Average Noise level: Resolution bandwidth 1 kHz, input attenuator 0 dB, video bandwidth 1 Hz.

R3465

Frequency range	Average Noise Level
10 kHz	-70 dBm
100 kHz	-80 dBm
1 MHz to 3.0 GHz	$-\{115 - 1.55 \times f(\text{GHz})\}$ dBm
1.7 GHz to 8.0 GHz	-115 dBm

R3272

Frequency range	Average Noise Level
10 kHz	-70 dBm
100 kHz	-80 dBm
1 MHz to 3.1 GHz	$-\{115 - 1.55 \times f(\text{GHz})\}$ dBm
3.0 GHz to 7.5 GHz	-110 dBm
7.5 GHz to 15.4 GHz	-103 dBm
15.2 GHz to 23.3 GHz	-96 dBm
23 GHz to 26.5 GHz	-90 dBm

R3263/3463

Frequency range	Average Noise Level
10 kHz	-70 dBm
100 kHz	-80 dBm
1 MHz to 3.0 GHz	$-\{115 - 1.55 \times f(\text{GHz})\}$ dBm

- **RELATED ADJUSTMENT**

Frequency response adjustment

- DESCRIPTION

This test measures the displayed average noise level in all frequency tests. The analyzer's input is terminated at 50  $\Omega$ . In Band 1, in the frequency range from 9 kHz to 3.0 GHz, the test first measures the average noise at 10 kHz and 100 kHz, then at any frequency point in zero span. For the rest of Band 1, and for all remaining bands, the test tunes the analyzer frequency across the band, uses the marker to locate the frequency with the highest response, and then reads the average noise in zero span.

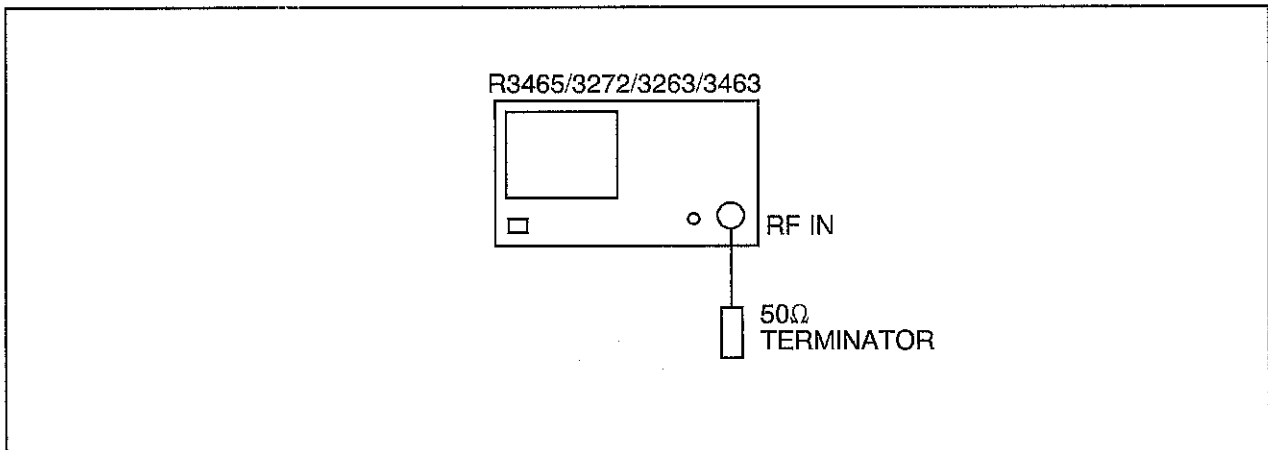

Figure 1-7 Displayed Average Noise Test Setup

- EQUIPMENT

  - 50  $\Omega$  Terminator



● **PROCEDURE**

[Displayed Average Noise, Band 0]

- (1) Connect the equipment as shown in Figure 1-7.

Press SHIFT , PRESET keys and set the controls as follows:

Center Frequency .....	10 kHz
Span Frequency .....	0 Hz
Reference Level .....	-60 dBm
Resolution Bandwidth .....	1 kHz
Video Bandwidth .....	1 Hz
Input Attenuator .....	0dB

- (2) Press SINGLE key and wait for a new sweep to finish, then press SRCH key.
- (3) Read the marker level and record it in Table 1-11 as the Displayed Noise Level at 10kHz.
- (4) Press FREQ , 1 , 0 , 0 and kHz keys.
- (5) Press SINGLE key and wait for a new sweep to finish, then press SRCH key.
- (6) Read the marker level and record it in Table 1-11 as the Displayed Noise Level at 100 kHz.
- (7) For the R3465, press FREQ , more 1/2 and Preselector  
1.7G 3.0G keys to set the preselector to 3.0 GHz.
- (8) Change the center frequency to each of the values listed in column 1 of Table 1-11 and repeat step 5 sequentially. Read the marker level and record it in Table 1-11 as the Displayed Noise level at Center Frequency.

[Displayed Average Noise Level, Band 1 (R3465/3272)]

(9) Press SHIFT , PRESET keys and set the controls as follows:

Start Frequency .....	1.7 GHz (3.0GHz for R3272)
Stop Frequency .....	7.0 GHz (7.5 GHz for R3272)
Reference Level .....	-40 dBm
Resolution Bandwidth .....	3 MHz
Video Bandwidth .....	100 kHz
Input Attenuator .....	0 dB

(10) Press FORMAT , Trace , AVG  
A , 1 , 0 , Hz keys and wait for averaging to finish.

(11) Press →CF and WRITE  
A keys.



(12) Set the controls as follows:

Span Frequency .....	0 Hz
Reference Level .....	-60 dBm
Resolution Bandwidth .....	1 kHz
Video Bandwidth .....	1 Hz

(13) Press SINGLE and SRCH keys.

(14) Read the marker level and record it in Table 1-11 as the Displayed Average Noise Level from 1.7 GHz (3.0 GHz for R3272) to 7.0 GHz (7.5 GHz for R3272).

[Displayed Average Noise Level, Band 2 (R3465/3272)]



(15) Press ,  and set the controls as follows:

Start Frequency	6.9 GHz (7.4 GHz for R3272)
Stop Frequency	8.0 GHz (15.4 GHz for R3272)
Reference Level	-40 dBm
Resolution Bandwidth	3 MHz
Video Bandwidth	100 kHz
Input Attenuator	0 dB

(16) Repeat steps (10) through (13).

(17) Read the marker level and record it in Table 1-11 as the Displayed Noise level from 6.9 GHz (7.4 GHz for R3272) to 8.0 GHz (15.4 GHz for R3272).

[Displayed Average Noise, Band 3 (R3272 only)]

(18) Press ,  and set the controls as follows:

Start Frequency	15.201 GHz
Stop Frequency	23.3 GHz
Reference Level	-40 dBm
Resolution Bandwidth	3 MHz
Video Bandwidth	100 kHz
Input Attenuator	0 dB

(19) Repeat steps (10) through (13).

(20) Read the marker level and record it in Table 1-11 as the Displayed Average Noise Level from 15.2 GHz to 23.3 GHz.

[Displayed Average Noise, Band 4 (R3272 only)]

(21) Press SHIFT , PRESET and set the controls as follows:

Start Frequency .....	23.001 GHz
Stop Frequency .....	26.5 GHz
Reference Level .....	-40 dBm
Resolution Bandwidth .....	3 MHz
Video Bandwidth .....	100 kHz
Input Attenuator .....	0 dB

(22) Repeat steps (10) through (13).

(23) Read the marker level and record it in Table 1-11 as the Displayed Average Noise Level from 23 GHz to 26.5 GHz.

Table 1-11 Displayed Average Noise Level (R3465)

Frequency	Displayed Average Noise Level (dBm)	Specification (dBm)
10 kHz		-70.0
100 kHz		-80.0
1.1 MHz		-114.99
101 MHz		-114.84
501 MHz		-114.22
1001 MHz		-113.45
1501 MHz		-112.67
2001 MHz		-111.90
2501 MHz		-111.12
2999 MHz		-110.35
1.7 GHz to 7.0 GHz		-115.0
6.9 GHz to 8 GHz		-115.0

Table 1-11 Displayed Average Noise Level (R3272)

Frequency	Displayed Average Noise Level (dBm)	Specification (dBm)
10 kHz		-70.0
100 kHz		-80.0
1.1 MHz		-114.99
101 MHz		-114.84
501 MHz		-114.22
1001 MHz		-113.45
1501 MHz		-112.67
2001 MHz		-111.90
2501 MHz		-111.12
2999 MHz		-110.35
3.0 GHz to 7.5 GHz		-110.0
7.4 GHz to 15.4 GHz		-103.0
15.2 GHz to 23.3 GHz		-96.0
23 GHz to 26.5 GHz		-90.0

Table 1-11 Displayed Average Noise Level (R3263/3463)

Frequency	Displayed Average Noise Level (dBm)	Specification (dBm)
10 kHz		-70.0
100 kHz		-80.0
1.1 MHz		-114.99
101 MHz		-114.84
501 MHz		-114.22
1001 MHz		-113.45
1501 MHz		-112.67
2001 MHz		-111.90
2501 MHz		-111.12
2999 MHz		-110.35

### 1.4.8 Gain Compression

- SPECIFICATION  
–5 dBm (mixer level) > 10 MHz
- RELATED ADJUSTMENT  
There is no related adjustment procedure for this performance test.
- DESCRIPTION  
This test means gain compression in the low and high bands.  
Two signals, separated by 1 MHz, are used. First a –30 dBm signal is placed at the input of the R3465/3272/3263/3463.  
After that, input a signal at –5 dBm or above and increase its signal level. The initial signal level at –30 dBm is lowered. Measure the input level when the signal is lowered by 1 dB.

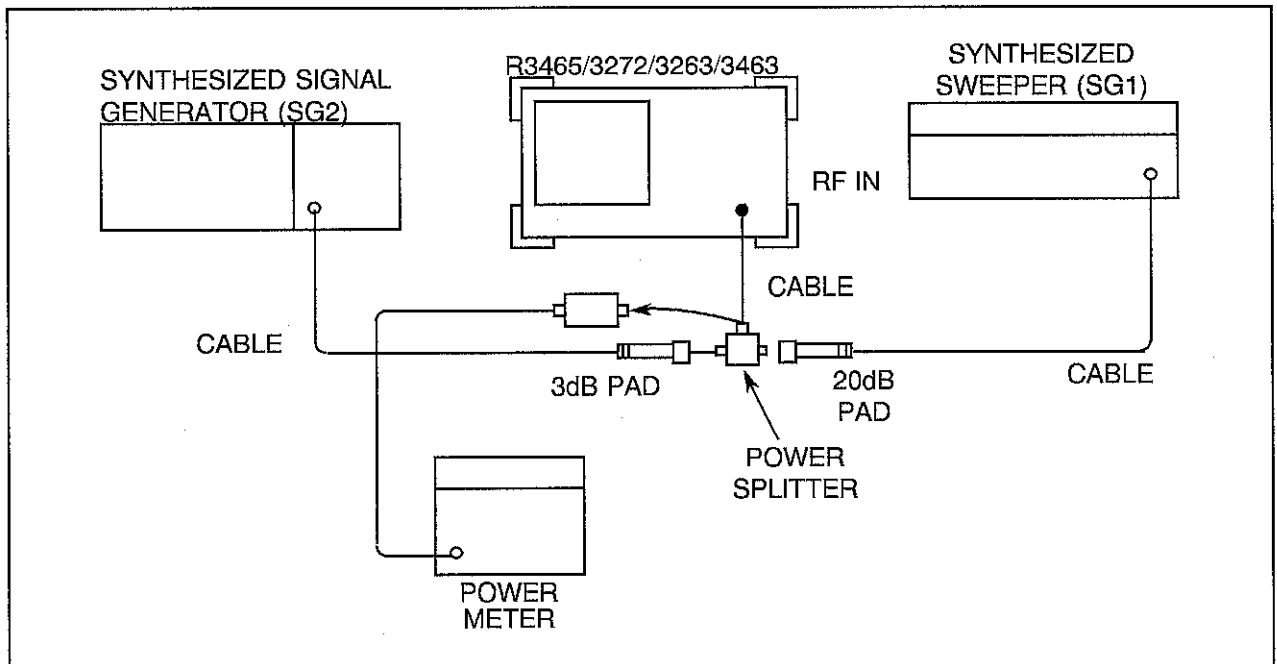

Figure 1-8 Gain Compression Test Setup

• EQUIPMENT

- Synthesized Sweeper (SG1)
- Synthesized Signal Generator (SG2)
- Power Meter
- Power Sensor (Sensor 1)
- Power Splitter
- 20 dB Pad
- 3 dB Pad
- Cable: SMA (Three required)

• PROCEDURE

- (1) Zero and calibrate the power meter.
- (2) Connect the equipment as shown in Figure 1-8.
- (3) Press the INSTR PRESET by on both the SG1 and the SG2.  
Set the controls for the SG2 as follows:

CW .....	821 MHz
Power Level .....	-2 dBm

- (4) Set the controls for the SG1 as follows:

CW .....	820 MHz
Power Level .....	-4 dBm

- (5) On the R3465/3272/3263/3463, press the SHIFT and PRESET keys.  
Set the R3465/3272/3263/3463 controls as follows:

Center Frequency .....	820.5 MHz
Span .....	2 MHz
ATT .....	0 dB
dB/div .....	1 dB/div

- (6) On the R3465/3272/3263/3463, press the LEVEL, 3, 0 and -dBm keys.

- (7) On the SG2, set the output to OFF.

- (8) Adjust the power level of the SG1 for a displayed signal level of  $-30 \text{ dBm} \pm 0.1 \text{ dB}$  on the R3465/3272/3263/3463 screen.



- (9) On the SG2, set the output to ON.
- (10) Turn the power level knob on the SG2 until the signal level at 2.5 div. in the lefthand part on the R3465/3272/3263/3463 screen is lowered by 1 dB from  $-30$  dBm. If the power level knob cannot be turned any more, stop it there.
- (11) Remove the SMA cable from the input terminal of the R3465/3272/3263 and connect the power sensor there.
- (12) Record the amplitude reading on the power meter.  
It should be greater than  $-5$  dBm \_\_\_\_\_ dBm

The following steps are to be performed for the R3465 and R3272.

- (13) Rotate the CAL FACTOR switch to the power sensor's 3.2 GHz calibration factor.  
On the SG2, set the output to OFF.
- (14) Set the SG2 controls as follows:

CW .....	3.201 GHz
Power Level .....	-2dBm

- (15) Set the SG1 controls as follows:

CW .....	3.2 GHz
----------	---------

- (16) Set the R3465/3272 controls as follows:

Center Freq .....	3.2005 GHz
Span .....	2 MHz
Ref Level .....	$-10$ dBm
dB/div .....	10 dB

- (17) On the R3465/3272, press FREQ key, more 1/2, PRESELE and AUTO PEAKING keys.  
Wait for the "peaking!!" message to disappear.  
Set the dB/div to 1dB/div.

- (18) Repeat steps (6) through (11).
- (19) Record the amplitude reading on the power meter.  
It should be greater than  $-5$  dBm.

\_\_\_\_\_ dBm

Table 1-12 Gain Compression

R3465/3272/3263/3463 Center Freq (MHz)	SG1 CW (MHz)	SG2 CW (MHz)	1dB Gain Compression level (dBm)
820.5	820	821	
3200.5	3200	3201	

### 1.4.9 Residual Response

- SPECIFICATION

R3465:	{	1 MHz to 3.0 GHz < - 100 dBm	(with no signal at input and 0 dB input attenuator. RF INPUT is terminated in 50 Ω.)
	}	300 kHz to 8 GHz < - 90 dBm	
R3272:	{	1 MHz to 3.0 GHz < - 100 dBm	
	}	300 kHz to 26.5 GHz < - 90 dBm	
R3263/3463:	{	1 MHz to 3.0 GHz < - 100 dBm	
	}	300 kHz to 3.0 GHz < - 90 dBm	

- RELATED ADJUSTMENT

There is no related adjustment for this performance test.

- DESCRIPTION

This test checks for residual responses. Any response located above the display line is measured in a narrow frequency span and resolution bandwidth. The RF INPUT is terminated in 50 Ω.

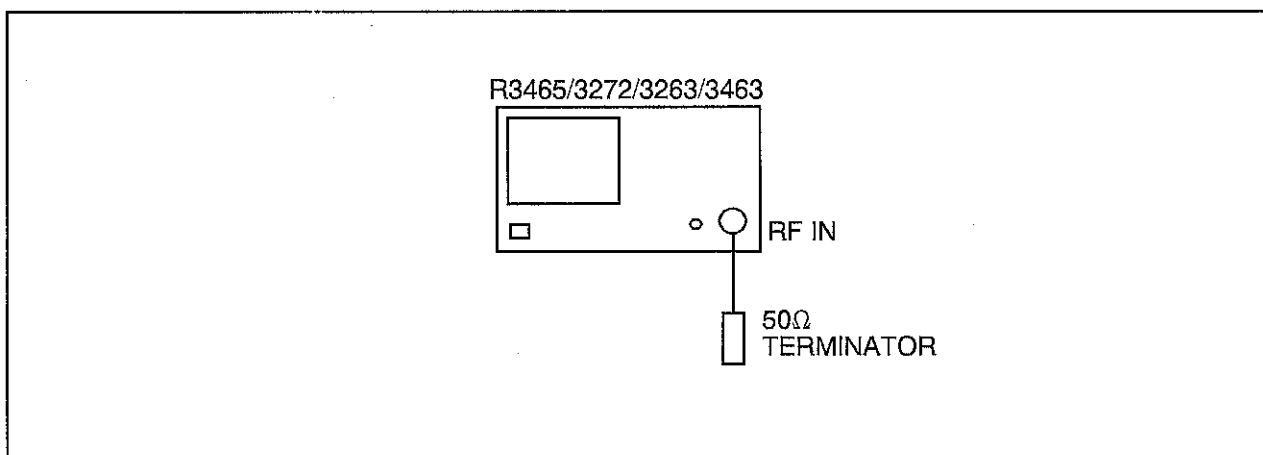

Figure 1-9 Residual Response Test Setup

- EQUIPMENT

Coaxial 50 Ω Termination

Adapters:

Type N to SMA



Type N to BNC

Cable:

BNC, 150cm





● PROCEDURE

- (1) Install the Type N to SMA adapter and 50 Ω termination on the RF INPUT. Press the

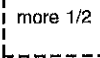
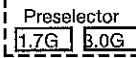
 ,  key and set the controls as follows:

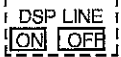
Center Frequency .....	1.3 MHz
Span .....	2 MHz
CF Step .....	1.9 MHz
Ref Level .....	-50 dBm
ATT .....	0 dB
RES BW .....	10 kHz
Video BW .....	300Hz

- (2) For the R3465, press the  ,  and  to set the preselector to 3.0 GHz.

- (3) Press the  ,  ,  ,  ,  and  keys.

Press the  key.

The noise level should be at least 3 dB below the display line. If it is not, it will be necessary to reduce the Span and RES BW to reduce the noise level.

If the Span is reduced, reduce the CF Step to no more than 95 % of the Span.

- (4) If a residual is suspected, press the  key again. A residual response will persist, but a noise peak will not. Record the frequency and amplitude of any responses above the display line.

(5) If a response is marginal, verify the response amplitude as follows:

- ① Press the REPEAT key.
- ② Place the marker on the peak of the response in question.
- ③ Press the →CF key.
- ④ Press the BW and RBW  
AUTO MNL keys to set the RBW to AUTO.
- ⑤ Continue to reduce the Span until a RES BW of 300 Hz is reached.

Press the →CF key.

⑥ Record the frequency and amplitude of any residual response above the display line.

(6) Check for residuals up to 3.0 GHz using the procedure of step (3) through (5) above. To change the center frequency, then press the FREQ and ↶ keys.

<<Residual Response, 1.7 GHz (3.0 GHz for R3272) to 8.0 GHz (26.5 GHz for R3272)  
Band >>

(7) Set the R3465/3272 as follows:

Center Frequency .....	1.725 GHz (3.025 GHz for R3272)
Span .....	50 MHz
CF Step .....	47.5 MHz
RES BW .....	300 kHz
Video BW .....	300 Hz

Press the DSP LINE  
ON/OFF, 9, 0, -dBm keys.

(8) For the R3465, press FREQ, more 1/2 and Preselector  
1.7G 3.0G to set the preselector to 1.7 GHz.

(9) Check for residuals up to center frequency 7.975 GHz (26.475 GHz for the R3272) using the procedure of steps (3) through (5) above. To change the center frequency, then press the FREQ and ↶ keys.

### 1.4.10 Second Harmonic Distortion

- SPECIFICATION

R3465: — [ - 70 dBc (10 MHz to 3.0 GHz, - 30 dBm mixer level)  
          [ - 90 dBc ( >1.7 GHz, - 10 dBm mixer level)

R3272: — [ - 70 dBc (10 MHz to 3.0 GHz, - 30 dBm mixer level)  
          [ - 100 dBc ( >3.0 GHz, - 10 dBm mixer level)

R3263/3463: — - 70 dBc (10 MHz to 3.0 GHz, - 30 dBm mixer level)

- RELATED ADJUSTMENT

There is no related adjustment procedure for the performance test.

- DESCRIPTION

A synthesized sweeper and low-pass filter provide the signal for measuring second harmonic distortion. The low-pass filter eliminates any harmonic distortion originating at the signal source. The R3465/3272/3263/3463 frequency response is calibrated. The synthesized sweeper is phase-locked to the spectrum analyzer's 10 MHz reference.

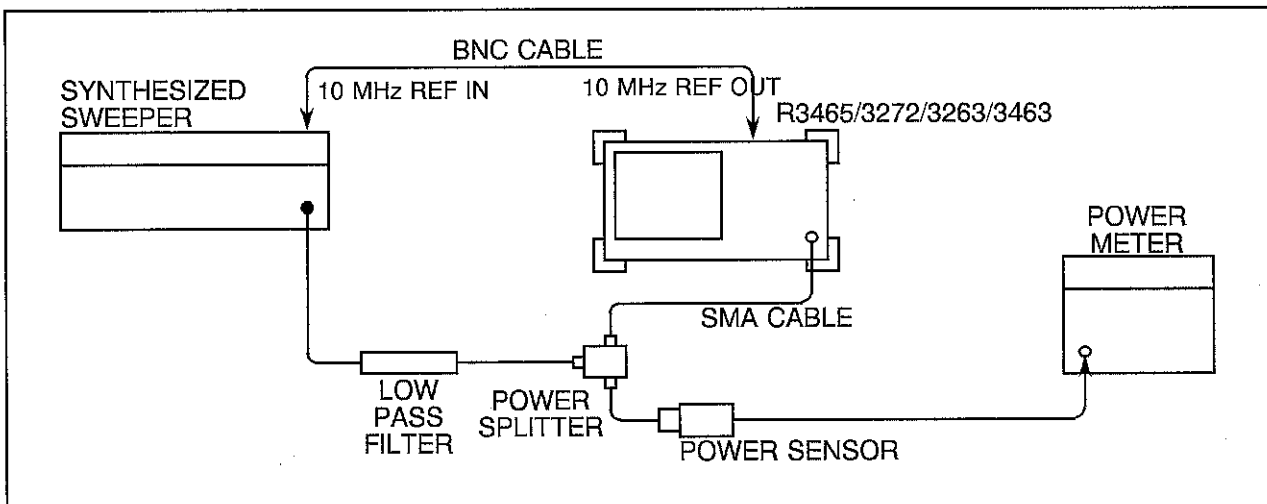

Figure 1-10 Second Harmonic Distortion Test Setup

● **EQUIPMENT**

- Synthesized Sweeper (SG1)
- Power Meter
- Power Sensor
- Power Splitter
- 2 GHz Low-pass Filter
- Adapter:
  - Type N to SMA
- Cables:
  - BNC, 150 cm
  - SMA, 70 cm

● **PROCEDURE**

[9 kHz to 3.0 GHz Band]

- (1) Zero and calibrate the power meter. Rotate the CAL FACTOR switch to the power sensor's 1.4 GHz calibration factor.
- (2) Connect the equipment as shown in Figure 1-10.

- (3) Press the INSTR PRESET key on the SG1. Set the SG1 controls as follows:

CW .....	1.4 GHz
Power Level .....	0 dBm
Frequency Standard Switch (rear panel) .....	EXT 10 MHz

- (4) On the R3465/3272/3263/3463, press SHIFT , PRESET keys and set the controls as follows:

Center Frequency .....	1.4 GHz
Span .....	10 kHz
VBW .....	30 Hz
ATT .....	20 dB
Ref Level .....	- 10 dBm

- (5) Set the SG1 POWER LEVEL key for a -10 dBm ± 0.1 dB reading on the power meter.

- (6) For the R3465, press FREQ , more 1/2 and Preselector  
1.7G 3.0G to set the preselector to 3.0 GHz.

(7) On the R3465/3272/3263/3463, press  ,  ,  ,  ,  and  keys to set the FIXED MKR to ON.

(8) On the R3465/3272/3263/3463, press  ,  ,  ,  ,  and  keys.

Wait for completion of the sweep.

Press  and record the  $\Delta$  MKR amplitude.

It should be less than -70 dBc.

Second Harmonic Distortion (<3.0 GHz) \_\_\_\_\_ dBc

[ > 1.7 GHz (3.0 GHz for R3272) Band (R3465/3272)]

(9) On the R3465/3272, press  ,  keys and set the controls as follows:

Center Frequency .....	3.8 GHz
Span .....	500 kHz

(10) Set the SG1 controls as follows:

CW .....	3.8 GHz
Power Level .....	- 10 dBm

(11) On the R3465/3272, press  ,  ,  and  keys.  
Wait for the "peaking" message to disappear.

(12) Set the SG1 controls as follows:

CW .....	1.9 GHz
Power Level .....	0 dBm

(13) Connect the equipment as shown in Figure 1-10.

(14) Rotate the CAL FACTOR switch to the power sensor's 1.9 GHz calibration factor.



(15) Set the SG1  key for a 0 dBm  $\pm$  0.1 dB reading on the power meter.

(16) On the R3465/3272, press , , ,  and  keys.

Press ,  and  keys.

Press , ,  and  to set the FIXED MKR to ON.

On the R3465/3272, press , , ,  and  keys.

Press , ,  and  keys.

Press   , ,  and  keys.

Wait for the end of 10 averagings.

Press  and record the  $\Delta$  MKR amplitude.

It should be less than - 100 dBc

Second Harmonic Distortion (> 1.7 GHz (3.0 GHz for R3272))  
\_\_\_\_\_dBc

**1.4.11 Third Order Intermodulation Distortion**

- SPECIFICATION

For a total mixer input level\* of -30 dBm:

R3465	R3272	R3263/3463
10 MHz to 3.0 GHz : < - 75 dBc 1.7 GHz to 8 GHz : < - 75 dBc	10 MHz to 3.0 GHz : < - 75 dBc 3.0 GHz to 26.5 GHz : < - 75 dBc	10 MHz to 3.0 GHz : - 75 dBc

\* Total mixer input level = Total Input Level - Input Attenuation

Converted Specification for a total mixer input level\* of -20dBm:

R3465	R3272	R3263/3463
10 MHz to 3.0 GHz : < - 55 dBc 1.7 GHz to 8 GHz : < - 55 dBc	10 MHz to 3.0 GHz : < - 55 dBc 3.0 GHz to 26.5 GHz : < - 55 dBc	10 MHz to 3.0 GHz : - 55 dBc

- RELATED ADJUSTMENT

There is no related adjustment procedure for this performance test.

- DESCRIPTION

Two synthesized sweepers provide the signals required for measuring third order intermodulation.

It is difficult when the input level is low because of being buried to the noise, to measure the spectrum generated by the distortion. Third order intermodulation distortion is raised by 20 dB if the input level is raised by 10 dB.

Then, examine with mixer input level set in -20 dBm after the spec is converted into a value which is 20dB larger.

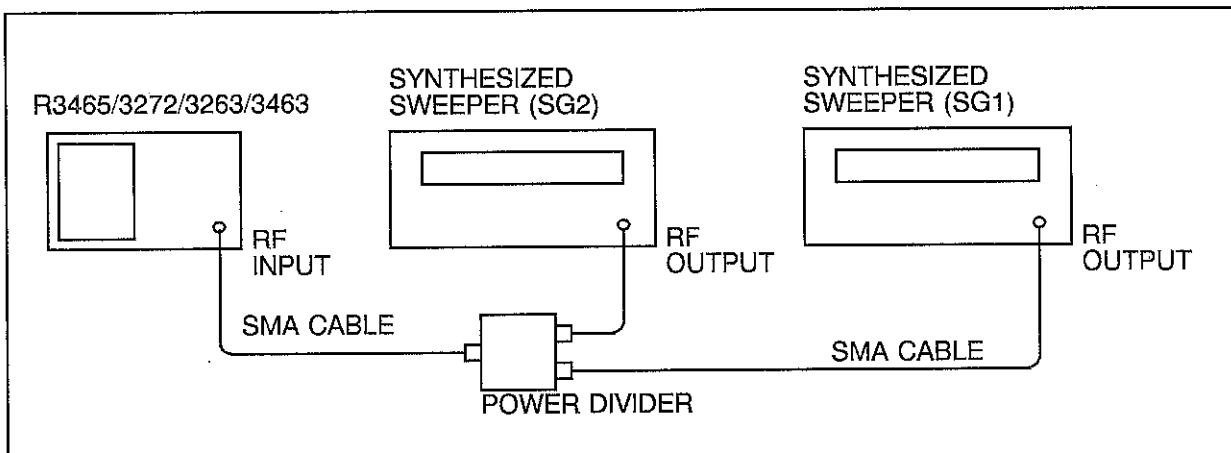

Figure 1-11 Third Order Intermodulation (<2 GHz) Test Setup

- EQUIPMENT

- Synthesized Sweeper (SG1)
- Synthesized Sweeper (SG2)
- Power Divider #1 (Divider 1)
- Power Divider #2 (Divider 2)
- Cables:
  - SMA, 70cm (Three required)

- PROCEDURE

The following procedure carry out at -20dBm for a total mixer input level.

[Third Order Intermodulation (<2 GHz)]

- (1) Select Divider 1 and connect the units as shown in Figure 1-11.
- (2) Press the INSTR PRESET key on each synthesized sweeper. Set each of the synthesized sweeper controls as follows:

Power Level .....	- 10 dBm
CW (SG1) .....	820.0125 MHz
CW (SG2) .....	820.000 MHz
RF Output .....	OFF

- (3) On the R3465/3272/3263/3463, press the SHIFT and PRESET keys. Set the R3465/3272/3263/3463 controls as follows:

Center Frequency .....	820.005 MHz
Ref Level .....	- 10 dBm
Freq Span .....	50 kHz
RBW .....	300 Hz
VBW .....	300 Hz
ATT .....	10 dB

- (4) On the SG1, set the output to ON.

- (5) On the R3465/3272/3263/3463, press the MARKER  
ON , Peak and CONT Peak  
ON OFF to set the CONT Peak to ON.
- (6) On the SG1, adjust the POWER LEVEL key for a  $-10 \text{ dBm} \pm 0.1 \text{ dB}$  reading on the R3465/3272/3263/3463 display.
- (7) On the SG1, set the output to OFF. On the SG2, set the output to ON.
- (8) On the SG2, adjust the POWER LEVEL key for a  $-10 \text{ dBm} \pm 0.1 \text{ dB}$  reading on the R3465/3272/3263/3463 display.
- (9) On the SG1, set the output to ON.
- (10) On the R3465/3272/3263/3463, press the following keys: CONT Peak  
ON OFF to set the CONT Peak to OFF and the SINGLE keys. Wait for a new sweep to finish.

Press the SRCH , MARKER  
ON and Delta MKR keys.

- (11) Third order intermodulation distortions appear symmetrically 12.5 kHz apart from the two carriers. Move MKR to each distorted position with the knob or  key, read the level in dBc and record the greater reading.

[Third Order Intermodulation, 3.2 GHz (R3465/3272)]

- (12) Change Divider 1 to 2.
- (13) Press the INSTR PRESET key on each synthesized sweeper. Set each of the synthesized sweeper controls as follows:

Power Level .....	- 10 dBm
CW (SG1) .....	3.2000125 GHz
CW (SG2) .....	3.2 GHz
RF Output .....	OFF

- (14) On the R3465/3272, press the SHIFT and PRESET keys. Set the R3465/3272 controls as follows:

Center Frequency .....	3.200005 GHz
Ref Level .....	- 10 dBm
Span .....	50 kHz
RBW .....	300 Hz
ATT .....	10 dB
VBW .....	300 HZ

- (15) Repeat steps (4) to (11) to measure the third order intermodulation distortions and record the greater reading.

Table 1-13 Third Order Intermodulation Distortion

SG1 [CW] (MHz)	SG2 [CW] (MHz)	Third Order Intermodulation Distortion	
		Actual (dBc)	Max (dBc)
820.0125	820		-55
3200.0125	3200		-55

### 1.4.12 Image, Multiple and Out-of-Band Response

- SPECIFICATION

Image, Multiple and Out-of-Band Response:

R3465:	- 70 dBc (10 MHz to 8 GHz)
R3272:	- 70 dBc (10 MHz to 18 GHz)
	- 60 dBc (10 MHz to 23 GHz)
	- 50 dBc (10 MHz to 26.5 GHz)

Image and Multiple Response:

R3263/3463:	- 70 dBc (10 MHz to 3 GHz)
-------------	----------------------------

- RELATED ADJUSTMENT

YTF adjustment

- DESCRIPTION

The performance tests in the R3465, R3272 and R3263/3463 differ in measurement frequency. Make measurement with each band.

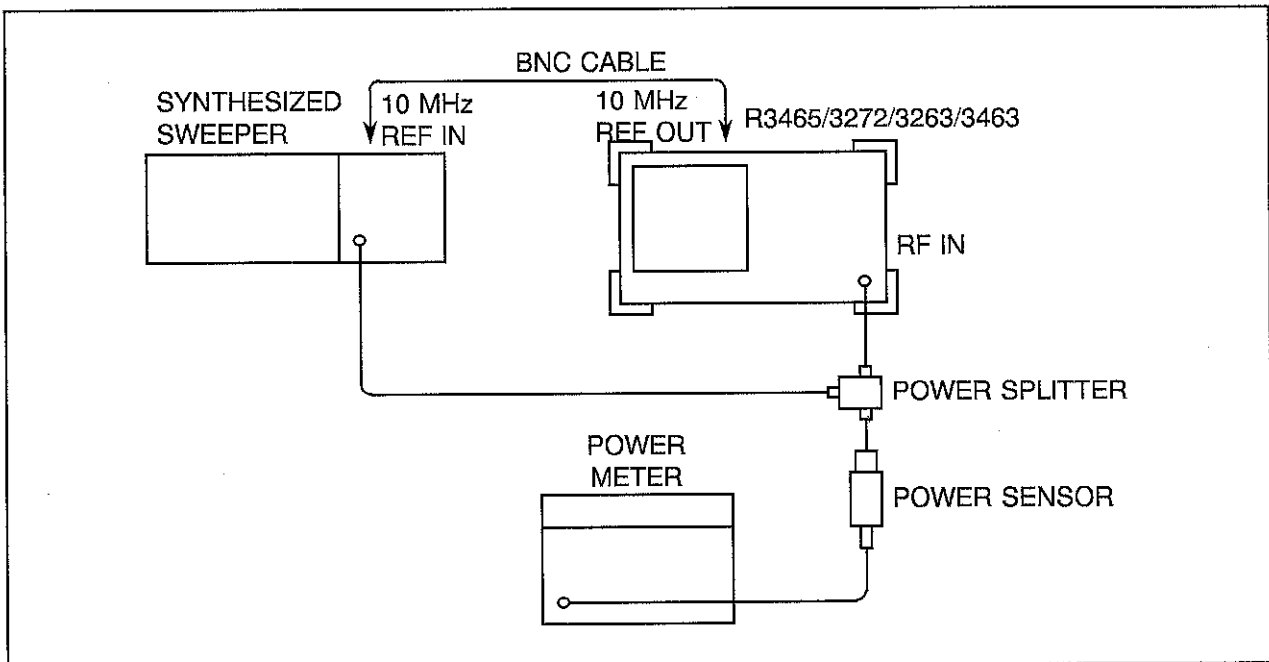

Figure 1-12 Image, Multiple and Out-of-Band Response Test Setup

● EQUIPMENT

- Synthesized Sweeper (SG3)
- Power Meter
- Power Sensor (Sensor 1)
- Power Splitter
- Adapter:
  - Type N to SMA
- Cable:
  - SMA, 70 cm

● PROCEDURE

[9 kHz to 3.0 GHz Band (R3465/3272/3263/3463)]

(1) Connect the equipment as shown in Figure 1-12, but do not connect the power sensor.

(2) Press the INSTR PRESET key on the SG3 and set the controls as follows:

CW .....	2 GHz
Power Level .....	0 dBm

(3) On the R3465/3272/3263/3463, press the SHIFT , PRESET keys and set the controls as follows:

Center Frequency .....	2 GHz
Span .....	40 MHz
RBW .....	100 kHz
VBW .....	300 Hz

(4) Zero and calibrate the power meter. Rotate the CAL FACTOR switch to the power sensor's 2 GHz calibration factor.

Connect the power sensor to the power splitter.

(5) Adjust the SG3 POWER LEVEL key for a 0 dBm  $\pm$  0.1 dB reading on the power meter.

(6) For the R3465, press FREQ , more 1/2 and Preselector  
1.7G 3.0G to set the preselector to 3.0 GHz.

- (7) On the R3465/3272/3263/3463, press  ,  ,  ,  ,  ,  ,  and  to set the FIXED MKR to ON.
- (8) For each of the frequencies listed in Table 1-14, 1-15 and 1-16 (Table 1-14: R3272, Table 1-15: R3465, Table 1-16: R3263/3463) for the 9 kHz to 3.1 GHz band, do the following:
- ① Set the SG3 to the listed  key frequency.
  - ② On the power meter, rotate the CAL FACTOR switch to the appropriate power sensor calibration factor.
  - ③ Set the SG3  key for a 0 dBm reading on the power meter.
  - ④ Press  key on the R3465/3272/3263/3463.
  - ⑤ On the R3465/3272/3263/3463, press  key and record the  $\Delta$ MKR amplitude in Table 1-14, 1-15 and 1-16 as the response amplitude. The response amplitude should be less than the specification listed in the table.
- (9) On the R3465/3272/3263/3463, press the  ,  and  keys.

Measurement frequency for the R3465 is different for the following bands. Therefore, skip steps (10) to (28) and restart from step (29). The following steps are for the R3272.



[3.0 to 7.5 GHz Band (R3272 Only)]

(10) On the R3272, press  ,  ,  ,  and  keys. Set the SG3  to 5.5 GHz.

(11) Rotate the CAL FACTOR switch to the power sensor's 5.5 GHz calibration factor on the power meter.

(12) On the SG3, set the power level to the power meter indicate 0dBm.

On the R3272, press  ,  ,  ,  ,  ,  ,  and  keys. Wait for the "peaking!!" message to disappear.

Press  ,  ,  ,  and   to set the FIXED MKR to ON.

(13) Repeat steps (8) and (9) for the SG3 frequencies listed in Table 1-14 for the 3.0 GHz to 7.5 GHz band.

[7.4 GHz to 15.4 GHz Band (R3272 Only)]

- (14) On the R3272, press the **FREQ** , **1** , **2** and **GHz** keys. Set the SG3 **CW** to 12 GHz.
- (15) Rotate the CAL FACTOR switch to the power sensor's 12 GHz calibration factor on the power meter.
- (16) Repeat step (12) for the R3272.
- (17) Repeat steps (8) and (9) for the SG3 frequencies listed in Table 1-14 for the 7.4 GHz to 15.4 GHz band.

[15.2 GHz to 23.3 GHz Band (R3272 Only)]

- (18) On the R3272, press the **FREQ** , **2** , **1** and **GHz** keys. Set the SG3 **CW** to 21 GHz.
- (19) Rotate the CAL FACTOR switch to the power sensor's 21 GHz calibration factor on the power meter.
- (20) Repeat step (12) for the R3272.
- (21) Repeat steps (8) and (9) for the sweeper frequencies listed in Table 1-14 for the 15.2 to 23.3 GHz band.

[23 to 26.5 GHz Band (R3272 Only)]

- (22) On the R3272, press the **FREQ** , **2** , **4** , **.** , **4** and **GHz** keys. Set the SG3 **CW** to 24.4 GHz.
- (23) Rotate the CAL FACTOR switch to the power sensor's 24.4 GHz calibration factor on the power meter.
- (24) Repeat step (12) for the R3272.
- (25) Repeat steps (8) and (9) for the SG3 frequencies listed in Table 1-14 for the 23 to 26.5 GHz band.

(26) Record the maximum response amplitude from Table 1-14.

(At frequency less than 18 GHz)

Maximum Response Amplitude (< 18 GHz) \_\_\_\_\_ dBc

(27) Record the maximum response amplitude from Table 1-14.

(At frequency ranging from 18 to 23 GHz)

Maximum Response Amplitude(< 23 GHz) \_\_\_\_\_ dBc

(28) Record the maximum response amplitude from Table 1-14.

(At frequency ranging from 23 to 26 GHz)

Maximum Response Amplitude(< 26.5GHz) \_\_\_\_\_ dBc

The following steps are for the R3465.

[1.7 to 8 GHz Band (R3465 Only)]

(29) Press  ,  and  keys to set the preselector to 1.7 GHz.

(30) On the R3465, press  ,  and  keys. Set the SG3  to 6 GHz.

(31) Rotate the CAL FACTOR switch to the power sensor's 6 GHz calibration factor on the power meter.

(32) On the SG3, set the power level to the power meter indicate 0dBm.

On the R3465, press  ,  ,  ,  ,  ,  and  keys. Wait for the "peaking!!" message to disappear.

Press  ,  ,  ,  and  keys to set the FIXED MKR to ON.

(33) Repeat steps (8) and (9) for the SG3 frequency listed in Table 1-15 for the 1.7 to 8 GHz band's 6 GHz center frequency.

(34) On the R3465, press  ,  and  keys. Set the SG3  to 8 GHz.

- (35) Rotate the CAL FACTOR switch to the power sensor's 8 GHz calibration factor on the power meter.
- (36) Repeat step (32) for the R3465.
- (37) Repeat steps (8) and (9) for the SG3 frequencies listed in Table 1-15 for the 1.7 to 8 GHz band's 8 GHz center frequency.
- (38) Record the maximum response amplitude from Table 1-15.

Maximum Response Amplitude \_\_\_\_\_ dBc

Table 1-14 Image, Multiple and Out-of-Band Responses (R3272)

Band	R3272 Center Freq. (GHz)	SG CW (MHz)	Response Amplitude (dBc)	Specification (dBc)
9 kHz to 3.1 GHz Band	2.0	1957.2		-70
	2.0	1157.2		-70
	2.0	10462.8		-70
	2.0	8231.4		-70
3.0 GHz to 7.5 GHz Band	5.5	6342.8		-70
	5.5	11421.4		-70
	5.5	17342.8		-70
	5.5	23264.2		-50
7.4 GHz to 15.4 GHz Band	12.0	12842.8		-70
	12.0	5789.3		-70
	12.0	18210.7		-60
	12.0	24421.4		-50
15.2 GHz to 23.3 GHz Band	21.0	21842.8		-60
	21.0	6719.06		-70
	21.0	13859.53		-70
23 GHz to 26.5 GHz Band	24.4	25242.8		-60
	24.4	5783.95		-70
	24.4	11989.3		-70
	24.4	18194.65		-60

Table 1-15 Image, Multiple and Out-of-Band Responses (R3465)

Band	R3465 Center Freq. (GHz)	SG CW (MHz)	Response Amplitude (dBc)	Specification (dBc)
9 kHz to 3.0 GHz Band	2.0	1957.2		-70
	2.0	1157.2		-70
	2.0	10462.8		-70
	2.0	8231.4		-70
1.7 GHz to 8 GHz Band	6.0	6842.8		-70
	8.0	4632.1		-70
	8.0	3789.3		-70

Table 1-16 Image and Multiple Responses (R3263/3463)

Band	R3263/3463 Center Freq. (GHz)	SG CW (MHz)	Response Amplitude (dBc)	Specification (dBc)
9 kHz to 3.0 GHz Band	2.0	1957.2		-70
	2.0	1157.2		-70

### 1.4.13 Frequency Response

- SPECIFICATION

R3465:	{	<ul style="list-style-type: none"> <li>± 1.5 dB (9 kHz to 3.0 GHz)</li> <li>± 1.0 dB (50 MHz to 3.0 GHz)</li> <li>± 1.5 dB (1.7 GHz to 7.0 GHz)</li> <li>± 1.5 dB (6.9 GHz to 8 GHz)</li> </ul>	(10 dB Input Attenuator)
R3272:	{	<ul style="list-style-type: none"> <li>± 1.5 dB (9 kHz to 3.1 GHz)</li> <li>± 1.0 dB (50 MHz to 3.1 GHz)</li> <li>± 1.5 dB (3.0 GHz to 7.5 GHz)</li> <li>± 3.5 dB (7.4 GHz to 15.4 GHz)</li> <li>± 4.0 dB (15.4 GHz to 23.3 GHz)</li> <li>± 4.0 dB (23 GHz to 26.5 GHz)</li> </ul>	
R3263/3463:	{	<ul style="list-style-type: none"> <li>± 1.5 dB (9 kHz to 3.0 GHz)</li> <li>± 1.0 dB (50 MHz to 3.0 GHz)</li> </ul>	

Frequency response relative to the calibrator (30 MHz):

R3465:	± 3 dB (9 kHz to 8 GHz)
R3272:	± 5 dB (9 kHz to 26.5 GHz)
R3263/3463:	± 2 dB (9 kHz to 3 GHz)

- RELATED ADJUSTMENT

YTF adjustment.

Frequency response adjustment.

- DESCRIPTION

The SG3 signal is fed through a power splitter to a power sensor and the R3465/3272/3263/3463. The SG3's power level is adjusted at 30 MHz to place the displayed signal at the R3465/3272/3263/3463 center horizontal graticule line. The power meter is placed in RATIO mode. At each new SG3 frequency, the SG3's power level is adjusted to the center horizontal graticule line. The power meter displays the inverse of the frequency response relative to the calibrator.

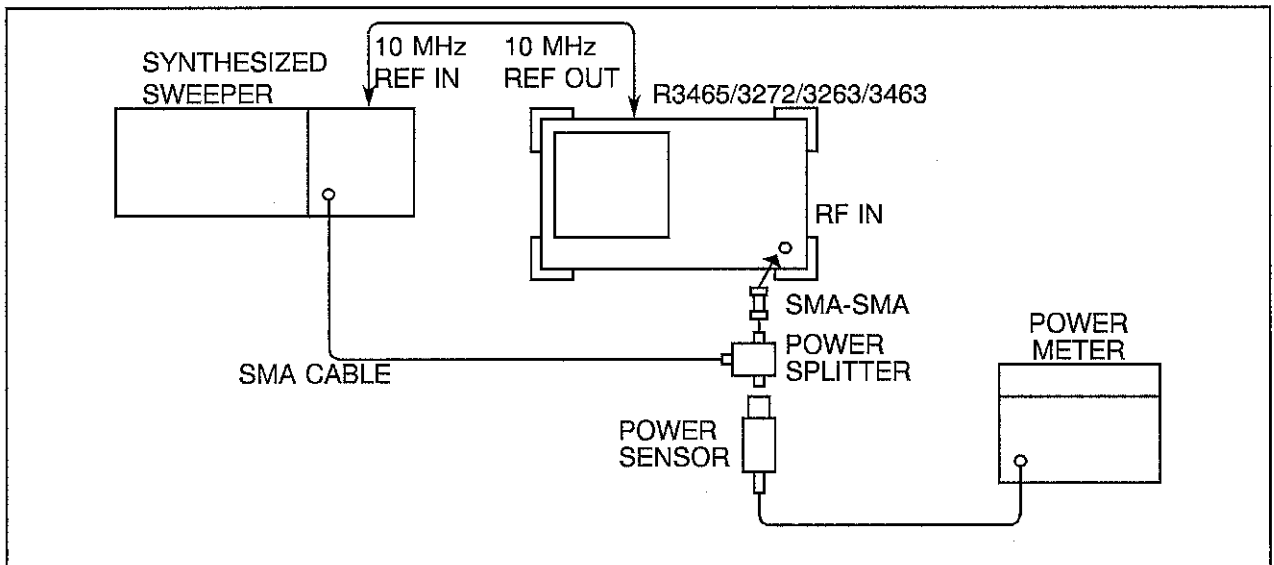

Figure 1-13 Frequency Response Test Setup

● EQUIPMENT

Synthesized Sweeper (SG3)

Power Meter

Power Sensor (Sensor 1)

Power splitter

Adapter:

Type N to SMA

SMA (m) to SMA (m)

Cables:

SMA, 70 cm (Two required)



● PROCEDURE

(1) Zero and calibrate the power meter.

(2) Connect the equipment as shown in Figure 1-13.

(3) Press the INSTR PRESET key on the SG3. Set the SG3 controls as follows:

CW .....	30 MHz
Freq Step .....	100 MHz
Power Level .....	- 4 dBm

- (4) On the R3465/3272/3263/3463, press the  and  keys.

Center Frequency .....	30 MHz
CF Step .....	100 MHz
Span .....	5 MHz
Ref Level .....	- 5 dBm
dB/div .....	2 dB/div
RBW .....	300 kHz
VBW .....	100 Hz
Trace Detector .....	Posi

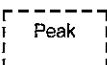
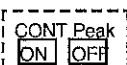
- (5) Press ,  and  keys to set the CONT PEAK to ON.





- (6) Adjust the SG3 POWER LEVEL for a MKR amplitude reading of - 10 dBm ± 0.09 dB.

- (7) Press the  switch on the power meter.

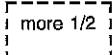
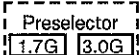
[Frequency Response (R3465/3272/3263/3463: 9 kHz to 3.0 GHz Band)]

- (8) Set the SG3  to 100 MHz.

- (9) For the R3465, press ,  and  to set the preselector to 3.0 GHz.

- (10) On the R3465/3272/3263/3463, press , , ,  and  keys.

- (11) Adjust the SG3 POWER LEVEL for an R3465/3272/3263/3463 MKR amplitude reading of - 10 dBm ± 0.09 dB.

- (12) Record the reverse sign value of the power ratio displayed on the power meter in Table 1-17.



(13) On the SG3, press the **CW** and up keys.

On the R3465/3272/3263/3463, press the **FREQ** and  keys.

At each new frequency, repeat steps (11) and (12), rotating the CAL FACTOR switch to the power sensor's calibration factor.

[Frequency Response (R3465: 1.7 to 7.0 GHz Band) (R3272: 3.0 to 7.5 GHz Band)]

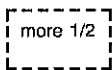
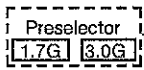
(14) For the R3465, press **FREQ**,  and  to set the preselector to 1.7 GHz.

(15) On the R3465/3272, press **FREQ**, **1**, **.**, **8** and **GHz** keys.  
( **3**, **.**, **1** for R3272)

(16) Set the SG3 **CW** to 1.8 GHz. (3.1 GHz for R3272)

(17) On the R3465/3272, press **SRCH**, **FREQ**, ,  and  keys.

Wait for the "peaking!!" message to disappear.

(18) Adjust the SG3 POWER LEVEL for an R3465/3272 MKR amplitude reading of  $-10$  dBm  $\pm 0.09$  dB.

(19) Record the reverse sign value of the power ratio displayed on the power meter in Table 1-18 and 1-19.

(20) On the SG3, press the **CW** and up keys.

On the R3465/3272, press the **FREQ** and  keys.

At each new frequency, repeat steps (17) through (19), rotating the CAL FACTOR switch to the power sensor's calibration factor.

[Frequency Response (R3465: 6.9 to 8.0 GHz Band) (R3272: 7.4 to 15.4 GHz Band)]

- (21) On the R3465/3272, press **FREQ**, **7**, **.**, **0** and **GHz** keys.  
( **7**, **.**, **5** for R3272)

Press **FREQ** and **CF STEP** **AUTO** **MNL** to set the CF STEP to MNL.

Press **2**, **0**, **0** and **MHz** keys.

- (22) Set the SG3 **CW** to 7.0 GHz (7.5 GHz for R3272) and **CF STEP SIZE** to 200 MHz.

- (23) On the R3465/3272, press **SRCH**, **FREQ**, **more 1/2**, **PRESELE** and **AUTO PEAKING** keys.  
Wait for the "peaking!!" message to disappear.

- (24) Adjust the SG3 POWER LEVEL for an R3465/3272 MKR amplitude reading of - 10 dBm ± 0.09 dB.

- (25) Recording the reverse sign value of the power ratio displayed on the power meter in Table 1-20 and 1-21.

- (26) On the SG3, press the **CW** and up keys.

On the R3465/3272, press the **FREQ** and  keys.

At each new frequency, repeat steps (23) through (25), rotating the CAL FACTOR switch to the power sensor's calibration factor.

[Frequency Response (R3272: 15.2 to 23.3 GHz Band)]

- (27) On the R3272, press **FREQ**, **1**, **5**, **.**, **4** and **GHz** keys.

- (28) Set the SG3 **CW** to 15.4 GHz.

- (29) On the R3272, press **SRCH**, **FREQ**, **more 1/2**, **PRESELE** and **AUTO PEAKING** keys.  
Wait for the "peaking!!" message to disappear.

- (30) Adjust the SG3 POWER LEVEL for an R3272 MKR amplitude reading of  $-10$  dBm  $\pm 0.09$  dB.
- (31) Record the negative value of the power ratio displayed on the power meter in Table 1-22.
- (32) On the SG3, press the **CW** and up keys.  
On the R3272, press the **FREQ** and  keys.  
At each new frequency, repeat steps (29) through (31), rotating the CAL FACTOR switch to the power sensor's calibration factor.

[Frequency Response (R3272:23 to 26.5 GHz Band)]

- (33) On the R3272, press **FREQ**, **2**, **3**, **.**, **4** and **GHz** keys.
- (34) Set the SG3 **CW** to 23.4 GHz.
- (35) On the R3272, press **SRCH**, **FREQ**, **more 1/2**, **PRESELE** and **AUTO PEAKING** keys.  
Wait for the "peaking!!" message to disappear.
- (36) Adjust the sweeper POWER LEVEL for an R3272 MKR amplitude reading of  $-10$  dBm  $\pm 0.09$  dB.
- (37) Record the reverse sign value of the power ratio displayed on the power meter in Table 1-23.
- (38) On the SG3, press the **CW** and up keys.  
On the R3272, press the **FREQ** and  keys.  
At each new frequency, repeat steps (35) through (37), rotating the CAL FACTOR switch to the power sensor's calibration factor.

[Test Results]

(40) Frequency Response (R3465/3272/3263/3463:9 kHz to 3.0 GHz Band)

① Enter the most positive number from Table 1-17, Power Meter Reading : \_\_\_\_\_ dB  
The absolute value of this number should be less than 5 dB.

② Enter the most negative number from Table 1-17, Power Meter Reading: \_\_\_\_\_ dB  
The absolute value of this number should be less than 5 dB.

③ Subtract ② from ①: \_\_\_\_\_ dB  
The result should be less than 3 dB.

(41) Frequency Response (R3465/3272/3263/3463:50 MHz to 3.0 GHz Band)

① Enter most positive number from Table 1-17, Power Meter Reading within the range of  
100 MHz to 3.0 GHz frequency: \_\_\_\_\_ dB

② Enter most negative number from Table 1-17, Power Meter Reading within the range of  
100 MHz to 3.0 GHz frequency: \_\_\_\_\_ dB

③ Subtract ② from ①: \_\_\_\_\_ dB  
The result should be less than 2 dB.

(42) Frequency Response (R3465: 1.7 GHz to 7.0 GHz Band)  
(R3272: 3.0 GHz to 7.5 GHz Band)

① Enter the most positive number from Table 1-18 and 1-19, Power Meter Reading: \_\_\_\_\_ dB  
The absolute value of this number should be less than 5 dB.

② Enter the most negative number from Table 1-18 and 1-19, Power Meter Reading: \_\_\_\_\_ dB  
The absolute value of this number should be less than 5 dB.

③ Subtract ② from ①: \_\_\_\_\_ dB  
The result should be less than 3 dB.

(43) Frequency Response (R3465:6.9 to 8 GHz Band)(R3271:7.4 to 15.4 GHz Band)

① Enter the most positive number from Table 1-20 and 1-21, Power Meter Reading: \_\_\_\_\_dB

The absolute value of this number should be less than 5 dB.

② Enter the most negative number from Table 1-20 and 1-21, Power Meter Reading: \_\_\_\_\_dB

The absolute value of this number should be less than 5 dB.

③ Subtract ② from ①: \_\_\_\_\_dB

The result should be less than 7 dB (R3465:3 dB).

(44) Frequency Response (R3272:15.2 to 23.3 GHz Band)

① Enter the most positive number from Table 1-22, Power Meter Reading: \_\_\_\_\_dB

The absolute value of this number should be less than 5 dB.

② Enter the most negative number from Table 1-22, Power Meter Reading: \_\_\_\_\_dB

The absolute value of this number should be less than 5 dB.

③ Subtract ② from ①: \_\_\_\_\_dB

The result should be less than 8 dB.

(45) Frequency Response (R3272:23 to 26.5 GHz Band)

① Enter the most positive number from Table 1-23, Power Meter Reading: \_\_\_\_\_dB

The absolute value of this number should be less than 5 dB.

② Enter the most negative number from Table 1-23, Power Meter Reading: \_\_\_\_\_dB

The absolute value of this number should be less than 5 dB.

③ Subtract ② from ①: \_\_\_\_\_dB

The result should be less than 8 dB.

Table 1-17 Frequency Response  
(R3465/3272/3263/3463 : 9 kHz to 3.0 GHz Band)

Column 1	Column 2	Column 3
Frequency (MHz)	Power Meter Reading (dB)	CAL Factor Freq. (GHz)
100		0.05
200		0.05
300		0.05
400		0.05
500		0.05
600		0.05
700		0.05
800		0.05
900		0.05
1000		1.0
1100		1.0
1200		1.0
1300		1.0
1400		1.0
1500		1.0
1600		1.0
1700		1.0
1800		1.0
1900		1.0
2000		2.0
2100		2.0
2200		2.0
2300		2.0
2400		2.0
2500		2.0
2600		2.0
2700		2.0
2800		2.0
2900		2.0
3000		3.0

**Spectrum Analyzer  
OPERATION MANUAL**

**1.4 Performance Test Process**

Table 1-18 Frequency Response (R3465 : 1.7 GHz to 7.0 GHz Band)

Column 1	Column 2	Column 3	Column 1	Column 2	Column 3
Frequency (GHz)	Power Meter Reading (dB)	CAL Factor Freq. (GHz)	Frequency (GHz)	Power Meter Reading (dB)	CAL Factor Freq. (GHz)
1.7		1.0	5.9		5.0
1.8		1.0	6.0		6.0
1.9		1.0	6.1		6.0
2.0		2.0	6.2		6.0
2.1		2.0	6.3		6.0
2.2		2.0	6.4		6.0
2.3		2.0	6.5		6.0
2.4		2.0	6.6		6.0
2.5		2.0	6.7		6.0
2.6		2.0	6.8		6.0
2.7		2.0	6.9		6.0
2.8		2.0	7.0		7.0
2.9		2.0			
3.0		3.0			
3.1		3.0			
3.2		3.0			
3.3		3.0			
3.4		3.0			
3.5		3.0			
3.6		3.0			
3.7		3.0			
3.8		3.0			
3.9		3.0			
4.0		4.0			
4.1		4.0			
4.2		4.0			
4.3		4.0			
4.4		4.0			
4.5		4.0			
4.6		4.0			
4.7		4.0			
4.8		4.0			
4.9		4.0			
5.0		5.0			
5.1		5.0			
5.2		5.0			
5.3		5.0			
5.4		5.0			
5.5		5.0			
5.6		5.0			
5.7		5.0			
5.8		5.0			

**Table 1-19 Frequency Response  
(R3272 : 3.0 GHz to 7.5 GHz Band)**

Column 1	Column 2	Column 3
Frequency (GHz)	Power Meter Reading (dB)	CAL Factor Freq. (GHz)
3.0		3.0
3.1		3.0
3.2		3.0
3.3		3.0
3.4		3.0
3.5		3.0
3.6		3.0
3.7		3.0
3.8		3.0
3.9		3.0
4.0		4.0
4.1		4.0
4.2		4.0
4.3		4.0
4.4		4.0
4.5		4.0
4.6		4.0
4.7		4.0
4.8		4.0
4.9		4.0
5.0		5.0
5.1		5.0
5.2		5.0
5.3		5.0
5.4		5.0
5.5		5.0
5.6		5.0
5.7		5.0
5.8		5.0
5.9		5.0
6.0		6.0
6.1		6.0
6.2		6.0
6.3		6.0
6.4		6.0
6.5		6.0
6.6		6.0
6.7		6.0
6.8		6.0
6.9		6.0
7.0		7.0
7.1		7.0
7.2		7.0
7.3		7.0
7.4		7.0



**Spectrum Analyzer  
OPERATION MANUAL**

**1.4 Performance Test Process**

Table 1-20 Frequency Response  
(R3465 : 6.9 GHz to 8 GHz Band)

Column 1	Column 2	Column 3
Frequency (GHz)	Power Meter Reading (dB)	CAL Factor Freq. (GHz)
6.9		6.0
7.1		7.0
7.3		7.0
7.5		7.0
7.7		7.0
7.9		7.0

Table 1-21 Frequency Response  
(R3272 : 7.4 GHz to 15.4 GHz Band)

Column 1	Column 2	Column 3
Frequency (GHz)	Power Meter Reading (dB)	CAL Factor Freq. (GHz)
7.5		7.0
7.7		7.0
7.9		7.0
8.1		8.0
8.3		8.0
8.5		8.0
8.7		8.0
8.9		8.0
9.1		9.0
9.3		9.0
9.5		9.0
9.7		9.0
9.9		9.0
10.1		10.0
10.3		10.0
10.5		10.0
10.7		10.0
10.9		10.0
11.1		11.0
11.3		11.0
11.5		11.0
11.7		11.0
11.9		11.0
12.1		12.0
12.3		12.0
12.5		12.0
12.7		12.0
12.9		12.0
13.1		13.0
13.3		13.0
13.5		13.0
13.7		13.0
13.9		13.0
14.1		14.0
14.3		14.0
14.5		14.0
14.7		14.0
14.9		14.0
15.1		15.0
15.3		15.0

Table 1-22 Frequency Response  
(R3272 : 15.2 GHz to 23.3 GHz Band)

Column 1	Column 2	Column 3
Frequency (GHz)	Power Meter Reading (dB)	CAL Factor Freq. (GHz)
15.4		15.0
15.6		15.0
15.8		15.0
16.0		16.0
16.2		16.0
16.4		16.0
16.6		16.0
16.8		16.0
17.0		17.0
17.2		17.0
17.4		17.0
17.6		17.0
17.8		17.0
18.0		18.0
18.2		18.0
18.4		18.0
18.6		18.0
18.8		18.0
19.0		19.0
19.2		19.0
19.4		19.0
19.6		19.0
19.8		19.0
20.0		20.0
20.2		20.0
20.4		20.0
20.6		20.0
20.8		20.0
21.0		21.0
21.2		21.0
21.4		21.0
21.6		21.0
21.8		21.0
22.0		22.0
22.2		22.0
22.4		22.0
22.6		22.0
22.8		22.0
23.0		23.0
23.2		23.0

Table 1-23 Frequency Response  
(R3272 : 23 GHz to 26.5 GHz Band)

Column 1	Column 2	Column 3
Frequency (GHz)	Power Meter Reading (dB)	CAL Factor Freq. (GHz)
23.4		23.0
23.6		23.0
23.8		23.0
24.0		24.0
24.2		24.0
24.4		24.0
24.6		24.0
24.8		24.0
25.0		25.0
25.2		25.0
25.4		25.0
25.6		25.5
25.8		25.5
26.0		26.0
26.2		26.0
26.4		26.0

### 1.4.14 IF Gain Uncertainty

- SPECIFICATION

IF Gain Uncertainty:

<  $\pm 0.5$  dB, reference levels 0 dBm to  $-50$  dBm with 10 dB input attenuation

- RELATED ADJUSTMENT

IF amplitude adjustment.

- DESCRIPTION

This test measures IF gain error in resolution band width 10 kHz and 3 kHz. The input signal level is decreased as the spectrum analyzer's reference level is decreased (IF gain increased). Since the signal level is decreased in precise steps, any error between the reference level and the signal level is caused by the analyzer's IF gain. The Synthesized Level Generator is phase-locked to the analyzer's 10 MHz reference.

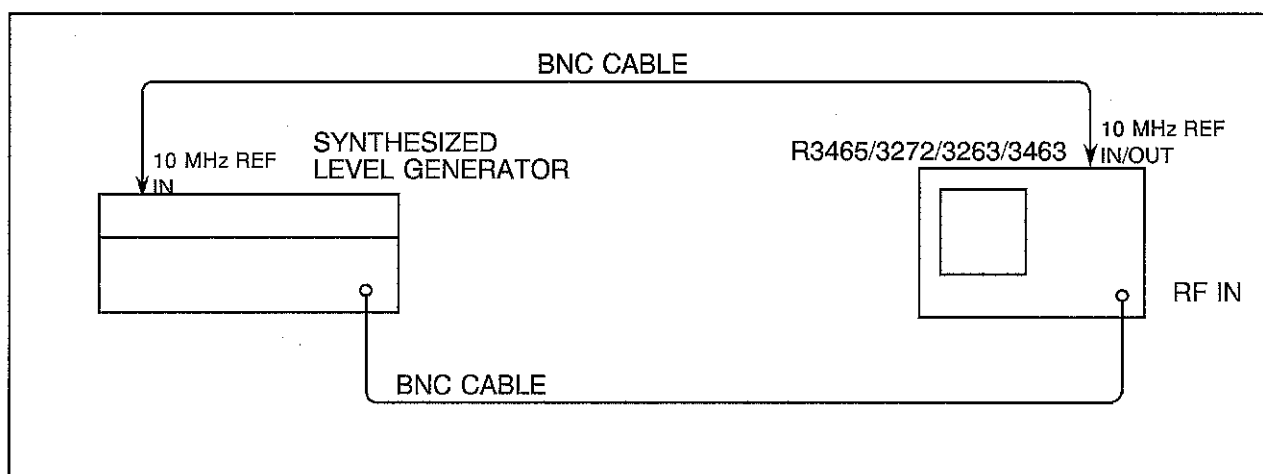

Figure 1-14 IF Gain Uncertainty Test Setup

- EQUIPMENT

Synthesized Level Generator (SG4)

Cables:

BNC, 150 cm (Two required)

● **PROCEDURE**

- (1) Connect the equipment as shown in Figure 1-14.
- (2) Set the SG4 controls as follows:

Frequency .....	30 MHz
Amplitude .....	- 5 dBm

- (3) On the R3465/3272/3263/3463, press the SHIFT and PRESET keys and set the controls as follows:

Center Frequency .....	30 MHz
Frequency Span .....	0 Hz
REF LEVEL .....	0 dBm
dB/div .....	1 dB/div
VBW .....	1 Hz
RBW .....	10 kHz
Trace Detector .....	Posi

- (4) Set the output level of the SG4 to the value 5 dB lower than the R3465/3272/3263/3463 reference level.

- (5) After several sweeps in the R3465/3272/3263/3463, press the SINGLE and SRCH keys to read the data on the screen and record it as the reference value. Then, press

the MARKER  
ON , Delta MKR and FIXED MKR  
ON OFF to set the FIXED MKR to ON.

- (6) Lower the SG4 level and the R3465/3272/3263/3463 reference level by 1 dB.  
Press SINGLE key.
- (7) Press the SRCH key to read the marker level on the screen and record it in Table 1-24.
- (8) Repeat steps (6) and (7) until the SG4 is lowered to 10 dB.
- (9) Lower the SG4 level and the R3465/3272/3263/3463 reference level by 10 dB.
- (10) Press the SRCH key to read the data on the screen and record it in Table 1-24.
- (11) Repeat steps (9) and (10) until the SG4 is lowered to 50 dB.
- (12) Repeat steps (2) to (11) above for the R3465/3272/3263/3463 resolution band width 3 kHz. For resolution band width 3 kHz, record the result in Table 1-25.

Table 1-24 IF Gain Error (RBW = 10 kHz, 1 dB/div. )

		Reference value (dBm)	
R3465/3272/3263/3463 Reference Level (dBm)	SG4 (dBm)	$\Delta$ Marker Level (dB)	Specification
0	-5	0 (Ref.)	—
-1	-6		$\pm 0.5$ dB
-2	-7		$\pm 0.5$ dB
-3	-8		$\pm 0.5$ dB
-4	-9		$\pm 0.5$ dB
-5	-10		$\pm 0.5$ dB
-6	-11		$\pm 0.5$ dB
-7	-12		$\pm 0.5$ dB
-8	-13		$\pm 0.5$ dB
-9	-14		$\pm 0.5$ dB
-10	-15		$\pm 0.5$ dB
-20	-25		$\pm 0.5$ dB
-30	-35		$\pm 0.5$ dB
-40	-45		$\pm 0.5$ dB
-50	-55		$\pm 0.5$ dB

Table 1-25 IF Gain Error (RBW = 3 kHz, 1 dB/div.)

		Reference value (dBm)	
R3465/3272/3263/3463 Reference Level (dBm)	SG4 (dBm)	$\Delta$ Marker Level (dB)	Specification
0	-5	0 (Ref.)	—
-1	-6		$\pm 0.5$ dB
-2	-7		$\pm 0.5$ dB
-3	-8		$\pm 0.5$ dB
-4	-9		$\pm 0.5$ dB
-5	-10		$\pm 0.5$ dB
-6	-11		$\pm 0.5$ dB
-7	-12		$\pm 0.5$ dB
-8	-13		$\pm 0.5$ dB
-9	-14		$\pm 0.5$ dB
-10	-15		$\pm 0.5$ dB
-20	-25		$\pm 0.5$ dB
-30	-35		$\pm 0.5$ dB
-40	-45		$\pm 0.5$ dB
-50	-55		$\pm 0.5$ dB

### 1.4.15 Scale Fidelity

- SPECIFICATION

Log Scale Fidelity:  $\pm 0.2$  dB/1 dB,

$\pm 1$  dB/10 dB to a maximum of  $\pm 1.5$  dB over 0 to 80 dB range.

Linear Scale Fidelity:  $< \pm 15\%$  of reference level

- RELATED ADJUSTMENT

IF amplitude adjustment.

- DESCRIPTION

This test measures display accuracy for 1 dB, 10 dB log scales, X1 linear scales. All scales are measured with 0 dBm reference signal. Figure 1-15 illustrates the measurement system of this test. The Synthesized Level Generator is phase-locked to the 10 MHz reference source of the spectrum analyzer.

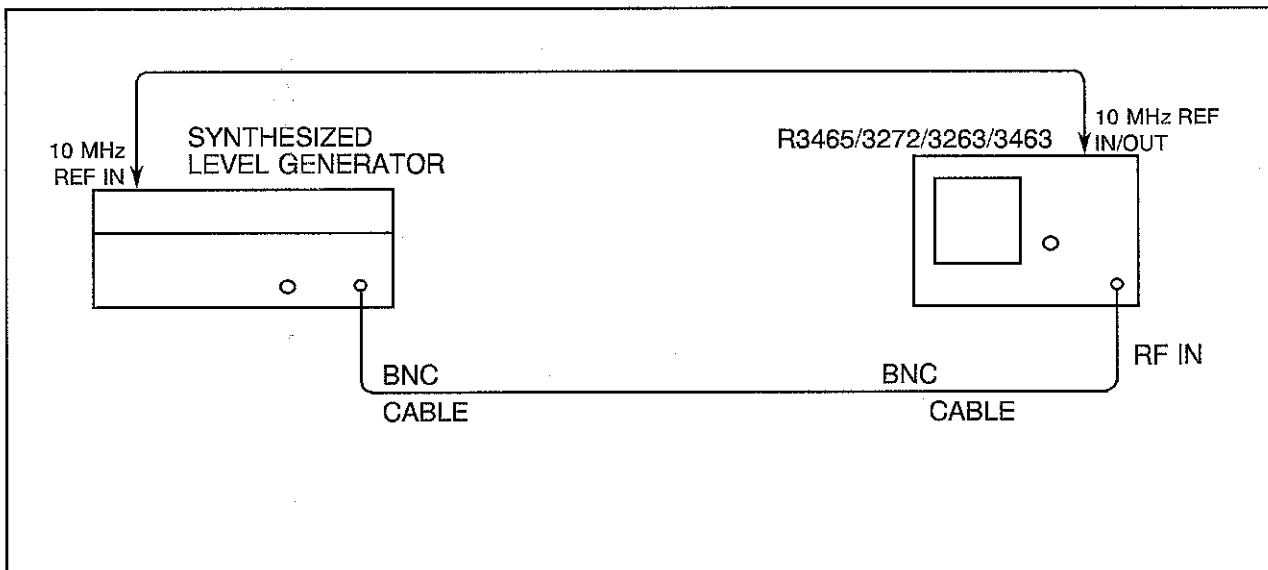

Figure 1-15 Scale Fidelity Test Setup

- EQUIPMENT

Synthesized Level Generator (SG4)

Cables:

BNC, 150 cm (Two required)



● PROCEDURE

- (1) Connect the equipment as shown in Figure 1-15.
- (2) Set the SG4 controls as follows:

Frequency ..... 30 MHz  
 Amplitude ..... 0 dBm

- (3) On the R3465/3272/3263/3463, press the SHIFT and PRESET keys and set the controls as follows:

Center Frequency ..... 30 MHz  
 Freq Span ..... 0 Hz  
 Ref Level ..... 0 dBm  
 RBW ..... 3 kHz  
 VBW ..... 1 Hz  
 dB/div ..... 1 dB/div  
 Trace Detector ..... Posi

- (4) On the R3465/3272/3263/3463, press the MARKER  
ON.

[1 dB/div Log Scale]

- (5) On the SG4, adjust the amplitude until the R3465/3272/3263 marker reads exactly 0.00 dBm.

- (6) On the R3465/3272/3263/3463, press the FORMAT, Trace, Trace B and Store B keys.

- (7) On the R3465/3272/3263/3463, press the MARKER  
ON, more 1/3, more 2/3, Trace MKR  
Move, more 3/3, Delta MKR, more 1/3, more 2/3 and Trace MKR  
Move keys.

- (8) On the R3465/3272/3263/3463, press the SINGLE key.

- (9) Lower the SG4 level by 1 dB.

- (10) On the R3465/3272/3263/3463, press the SINGLE key.

- (11) Record the Delta marker level in the Actual column in Table 1-26. Calculate the incremental error according to the following equation and record the result in the Incremental Error column in Table 1-26.

$$\text{Incremental error} = (\text{Current Delta marker level}) - (\text{Previous Delta marker level}) + 1 \text{ dB}$$

- (12) Repeat steps (9) to (11) until the SG4 level is set to the value 10 dB lower than the initially set level.

[10 dB/div Log Scale]

- (13) On the R3465/3272/3263/3463, press the  ,  ,  and  keys.

- (14) Set the SG4 level so that the R3465/3272/3263/3463 marker indicates just 0.00 dBm.

- (15) On the R3465/3272/3263/3463, press the  ,  ,  and  keys.

- (16) On the R3465/3272/3263/3463, press the  ,  ,  ,  ,  ,  ,  ,  and  keys.

- (17) Lower the SG4 level by 10 dB.

- (18) On the R3465/3272/3263/3463, press the  key.

- (19) Record the Delta marker level in the Actual column in Table 1-27. Calculate the incremental error from the following expression and record the result in the Incremental Error column in Table 1-27.

$$\text{Incremental error} = (\text{Current Delta marker level}) - (\text{Previous Delta marker level}) + 10 \text{ dB}$$

- (20) Repeat steps (17) to (19) until the frequency synthesizer level is set to the value 80 dB lower than the initially set level.

Table 1-26 1 dB/div. Log Scale Fidelity (RBW = 3 kHz)

Input Signal Level (dBm, nominal)	dB from Reference Level (nominal)	$\Delta$ Marker Level			Incremental Error (dB)
		Min. (dBm)	Actual (dBm)	Max. (dBm)	
0	0	0	0 (Ref.)	0	0 (Ref.)
-1	-1	-1.2		-0.8	
-2	-2	-2.4		-1.6	
-3	-3	-3.6		-2.4	
-4	-4	-4.8		-3.2	
-5	-5	-6.0		-4.0	
-6	-6	-7.2		-4.8	
-7	-7	-8.4		-5.6	
-8	-8	-9.5		-6.5	
-9	-9	-10.5		-7.5	
-10	-10	-11.5		-8.5	

Table 1-27 10 dB/div. Log Scale Fidelity (RBW = 3 kHz)

Input Signal Level (dBm, nominal)	dB from Reference Level (nominal)	$\Delta$ Marker Level			Incremental Error (dB)
		Min. (dBm)	Actual (dBm)	Max. (dBm)	
0	0	0	0 (Ref.)	0	0 (Ref.)
-10	-10	-11		-9	
-20	-20	-21.5		-18.5	
-30	-30	-31.5		-28.5	
-40	-40	-41.5		-38.5	
-50	-50	-51.5		-48.5	
-60	-60	-61.5		-58.5	
-70	-70	-71.5		-68.5	
-80	-80	-81.5		-78.5	

[Linear Scale]

(21) Set the SG4 as follows:

Frequency .....	30 MHz
Amplitude .....	0 dBm

(22) On the R3465/3272/3263/3463, press the SHIFT and PRESET keys and set the controls as follows:

Center Freq .....	30 MHz
Freq Span .....	0 kHz
Ref Level .....	0 dBm
RBW .....	3 kHz
VBW .....	1 kHz
Trace Detector .....	Posi

(23) On the R3465/3272/3263/3463, press the LEVEL, LINEAR and X1 keys to select the linear X1 mode. Then, press the MARKER ON key.

(24) Precisely set the SG4 level to the R3465/3272/3263/3463 reference level while reading the marker level on the screen.

(25) On the R3465/3272/3263/3463, press the SINGLE key to set the single sweep mode.

(26) Read the level value displayed on the SG4 and set the value as the reference value (Ref). Then, set the frequency synthesizer level to the value 0.92 dB lower than the reference value.

(27) On the R3465/3272/3263/3463, perform single sweep, read the marker level and record it in Table 1-28.

(28) Set the SG4 level as shown in the Input Signal Level column in Table 1-28 sequentially and repeat step (27) for each.

Table 1-28 Linear Scale Fidelity (X1)

Input Signal Level		Div. from Reference Level	$\Delta$ Marker Level		
(dB, nominal)	(mV, nominal)		Min. (mV)	Actual (mV)	Max. (mV)
0 (Ref.)	223.6	0	223.6	223.6 (Ref.)	223.6
-0.92	201.24	1	167.7		234.8
-1.94	178.88	2	145.3		212.5
-3.10	156.52	3	122.9		190.1
-4.44	134.16	4	100.6		167.7
-6.02	111.8	5	78.2		145.4
-7.96	89.44	6	55.9		122.0
-10.46	67.08	7	33.5		100.7
-13.98	44.72	8	11.1		78.3

### 1.4.16 Input Attenuator Accuracy

- SPECIFICATION

Input attenuator accuracy (referenced to 10 dB input attenuation, for 20 to 70 dB settings):

R3465:	9 kHz to 8 GHz:	< $\pm 1.1$ dB/10 dB step to a maximum of $\pm 2.0$ dB
R3272:	{	9 kHz to 12.4 GHz: < $\pm 1.1$ dB/10 dB step to a maximum of $\pm 2.0$ dB
	{	12.4 GHz to 18 GHz: < $\pm 1.3$ dB/10 dB step to a maximum of $\pm 2.5$ dB
	{	18 GHz to 26.5 GHz: < $\pm 1.8$ dB/10 dB step to a maximum of $\pm 3.5$ dB
R3263/3463:	9 kHz to 3 GHz:	< $\pm 1.1$ dB/10 dB step to a maximum of $\pm 2.0$ dB

- RELATED ADJUSTMENT

There is no related adjustment procedure for this performance test.

- DESCRIPTION

This test measures the input attenuator's switching accuracy over the full 70 dB.

The number of frequency measured points is one point at 4 GHz for the R3465, one point at 1.5 GHz for the R3263/3463 and three points at 4 GHz, 15 GHz and 18 GHz for the R3272.

The synthesized sweeper is phase-locked to the spectrum analyzer's 10 MHz reference. The input attenuator switching accuracy is referenced to the 10 dB attenuator setting. Step-to-step accuracy is calculated from switching accuracy data.

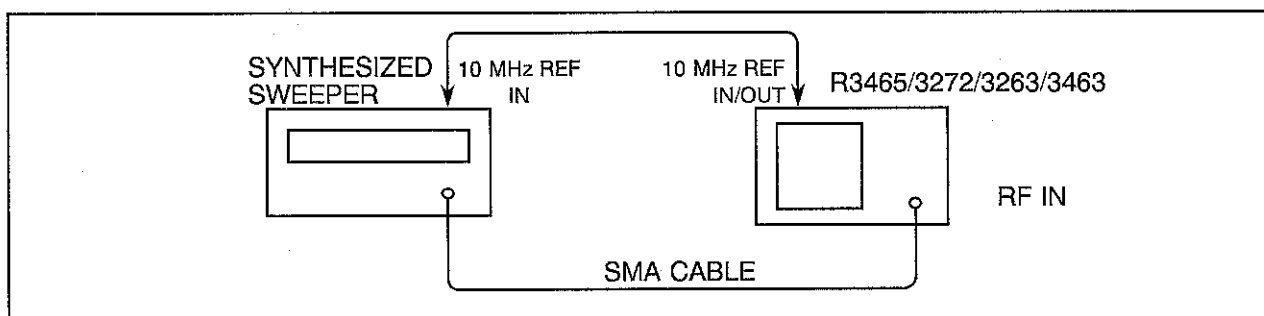

Figure 1-16 Input Attenuator Switching Accuracy Test Setup

- EQUIPMENT

Synthesized Sweeper (SG1)

Cables:

BNC, 150cm

SMA, 70cm

● PROCEDURE

- (1) IF gain uncertainty is measured when the resolution bandwidth is set to 3kHz and the result is filled in on the IF Gain uncertainty of Table 1-29.  
For the test method, refer to "1.4.14 IF Gain Uncertainty".

**CAUTION**

Measure IF gain uncertainty when the resolution bandwidth is set to 3 kHz before doing this test. IF gain uncertainty is included in the measurement result because of IF gain's changing and measuring in this test.

- (2) Connect the equipment as shown in Figure 1-16.  
(3) Set the SG1 controls as follows:

Frequency (for the R3465/3272) .....	4 GHz
(for the R3263/3463) .....	1.5 GHz
Amplitude .....	-5 dBm

- (4) On the R3465/3272/3263/3463, press the SHIFT and PRESET keys and set the controls as follows:

Center Frequency (for the R3465/3272) .....	4 GHz
(for the R3263/3463) .....	1.5 GHz
Frequency Span .....	10 kHz
Ref Level .....	0 dBm
dB/div .....	1 dB/div
RBW .....	3 kHz
Trace Detector .....	Posi

- (5) On the SG4, adjust the POWER LEVEL to the value 5 dB lower than the R3465/3272/3263/3463 reference level.

- (6) On the R3465/3272/3263/3463, press the SINGLE key.

Press the SRCH key, read the MKR level and record it in Table 1-29 as the reference value.

- (7) On the R3465/3272/3263/3463, press the ATT and ATT AUTO  
AUTO MNL keys to set the ATT AUTO to MNL.

(8) Press the  key.

(9) On the R3465/3272/3263/3463, press the SINGLE key.

Press the SRCH key, read the MKR level. The marker level measured here is subtracted from the reference value measure in the (6).

IF gain uncertainty measured in the (1) is subtracted from the value.

Records it in Table 1-29 as Actual MKR Reading.

$$\text{Actual MKR Reading} = \boxed{\begin{array}{l} \text{Reference value} \\ \text{measured in the} \\ \text{(6)} \end{array}} - \boxed{\begin{array}{l} \text{Marker level} \\ \text{measured in} \\ \text{the (9)} \end{array}} - \boxed{\begin{array}{l} \text{IF gain uncertainty} \\ \text{measured in the} \\ \text{(1)} \end{array}}$$

(10) Repeat steps (7) through (9) for the remaining R3465/3272/3263/3463 ATT setting listed in Table 1-29.

(11) Calculate the step-to-step accuracy as described in the following steps and record the results in Table 1-29. Step-to-step accuracy should be within the limits shown in Table 1-29.

[Step-to-Step Accuracy Calculation]

(12) For the 20 dB ATT setting, switching accuracy becomes step-to-step accuracy.

(13) For the 30, 40, 50, 60 and 70 dB ATT settings, subtract the 10dB down ATT switching accuracy from the current ATT switching accuracy.

(14) Center Frequency is changed to 15GHz and 18GHz and the operations in (2) to (13) are executed for R3272. Fill in the value measured in the (1) when Center Frequency is 4GHz (1.5 GHz for the R3263/3463) on the IF Gain Uncertainty Table 1-29.



Table 1-29 Input Attenuator Accuracy

[R3465] Center Frequency: 4 GHz, Reference value \_\_\_\_ dBm

R3465 Attenuator (dB)	IF Gain (dB)	IF Gain Uncertainty (dB)	Switching Accuracy			Step-to-Step Accuracy	
			Min. (dB)	Actual (dB)	Max. (dB)	Actual (dB)	Spec. (dB)
10	0	0	0 (Ref.)	0 (Ref.)	0 (Ref.)	0 (Ref.)	0 (Ref.)
20	10		-2		+2		±1.1
30	20		-2		+2		±1.1
40	30		-2		+2		±1.1
50	40		-2		+2		±1.1
60	50		-2		+2		±1.1
70	60		-2		+2		±1.1

[R3272] Center Frequency: 4 GHz, Reference value \_\_\_\_ dBm

R3272 Attenuator (dB)	IF Gain (dB)	IF Gain Uncertainty (dB)	Switching Accuracy			Step-to-Step Accuracy	
			Min. (dB)	Actual (dB)	Max. (dB)	Actual (dB)	Spec. (dB)
10	0	0	0 (Ref.)	0 (Ref.)	0 (Ref.)	0 (Ref.)	0 (Ref.)
20	10		-2		+2		±1.1
30	20		-2		+2		±1.1
40	30		-2		+2		±1.1
50	40		-2		+2		±1.1
60	50		-2		+2		±1.1
70	60		-2		+2		±1.1

[R3272] Center Frequency: 15 GHz, Reference value \_\_\_\_ dBm

R3272 Attenuator (dB)	IF Gain (dB)	IF Gain Uncertainty (dB)	Switching Accuracy			Step-to-Step Accuracy	
			Min. (dB)	Actual (dB)	Max. (dB)	Actual (dB)	Spec. (dB)
10	0	0	0 (Ref.)	0 (Ref.)	0 (Ref.)	0 (Ref.)	0 (Ref.)
20	10		-2.5		+2.5		±1.3
30	20		-2.5		+2.5		±1.3
40	30		-2.5		+2.5		±1.3
50	40		-2.5		+2.5		±1.3
60	50		-2.5		+2.5		±1.3
70	60		-2.5		+2.5		±1.3

**Spectrum Analyzer  
OPERATION MANUAL**

**1.4 Performance Test Process**

(cont'd)

[R3272] Center Frequency: 18 GHz, Reference value \_\_\_\_ dBm

R3272 Attenuator (dB)	IF Gain (dB)	IF Gain Uncertainty (dB)	Switching Accuracy			Step-to-Step Accuracy	
			Min. (dB)	Actual (dB)	Max. (dB)	Actual (dB)	Spec. (dB)
10	0	0	0 (Ref.)	0 (Ref.)	0 (Ref.)	0 (Ref.)	0 (Ref.)
20	10		-3.5		+3.5		± 1.8
30	20		-3.5		+3.5		± 1.8
40	30		-3.5		+3.5		± 1.8
50	40		-3.5		+3.5		± 1.8
60	50		-3.5		+3.5		± 1.8
70	60		-3.5		+3.5		± 1.8

[R3263/3463] Center Frequency: 1.5 GHz, Reference value \_\_\_\_ dBm

R3263/3463 Attenuator (dB)	IF Gain (dB)	IF Gain Uncertainty (dB)	Switching Accuracy			Step-to-Step Accuracy	
			Min. (dB)	Actual (dB)	Max. (dB)	Actual (dB)	Spec. (dB)
10	0	0	0 (Ref.)	0 (Ref.)	0 (Ref.)	0 (Ref.)	0 (Ref.)
20	10		-2		+2		± 1.1
30	20		-2		+2		± 1.1
40	30		-2		+2		± 1.1
50	40		-2		+2		± 1.1
60	50		-2		+2		± 1.1
70	60		-2		+2		± 1.1

### 1.4.17 Calibration Amplitude Accuracy

- SPECIFICATION

Amplitude:  $-10 \text{ dBm} \pm 0.3 \text{ dB}$

- RELATED ADJUSTMENT

Calibration amplitude adjustment.

- DESCRIPTION

The amplitude accuracy of the CALOUT signal are checked for  $-10 \text{ dBm} \pm 0.3 \text{ dB}$ .

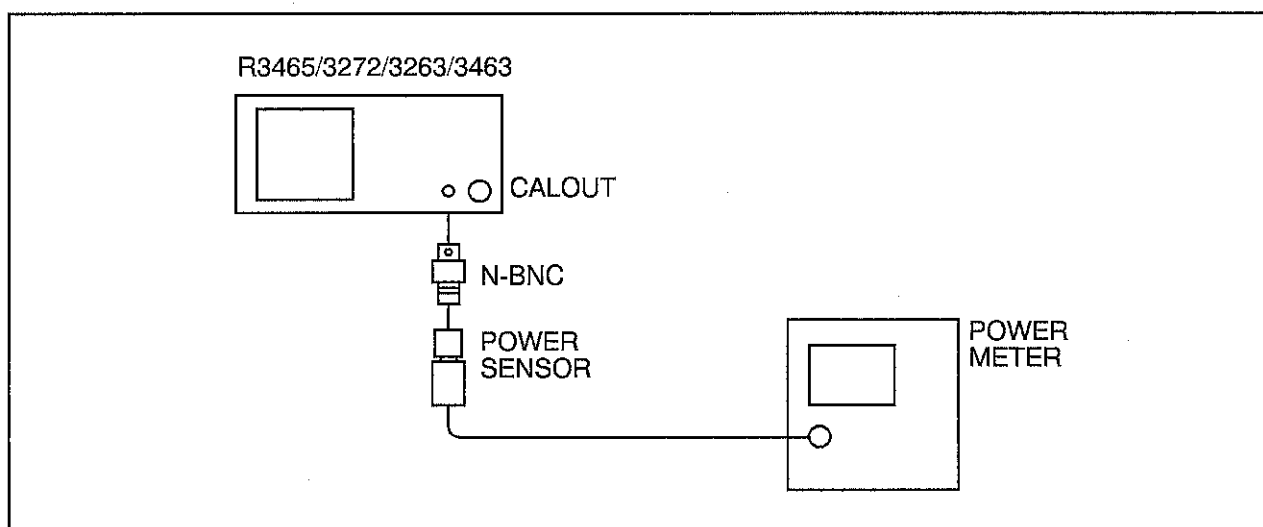

Figure 1-17 Calibration Amplitude Accuracy Test Setup

- EQUIPMENT

Power Meter  
Power Sensor (Sensor 2)

- PROCEDURE

- (1) Connect the equipment as shown in Figure 1-17.
- (2) Press the power sensor zero of the power meter and calibrate the power sensor. Enter the power sensor's 30 MHz calibration factor into the power meter.
- (3) Connect the power sensor via an N(f) – BNC(m) adapter directly to the CALOUT connector. Read the power meter display. The power level should be within the following limits ( $\pm 0.3 \text{ dB}$ ):

$$-10.3 \text{ dBm} \leq \text{Actual} \leq -9.7 \text{ dBm}$$

1.5 Checklist/Data Form

File No. : \_\_\_\_\_ Description : SPECTRUM ANALYZER  
 UUT MFR : ADVANTEST CO. ID No. : \_\_\_\_\_  
 Model : R3465/3272/3263/3463 Date : \_\_\_\_\_

Table 1-30 Performance Test Record (1 of 11)

Para. No.	Test Description	Results		
		Min.	Actual	Max.
1	Frequency Readout Accuracy and Frequency Counter Marker Accuracy			
	1.5 GHz CENTER FREQ			
	1 MHz SPAN	1.499988 GHz		1.500012 GHz
	10 MHz SPAN	1.49958 GHz		1.50042 GHz
	50 MHz SPAN	1.49784 GHz		1.50216 GHz
	100 MHz SPAN	1.4958 GHz		1.4042 GHz
	2 GHz SPAN	1.419 GHz		1.581 GHz
	5.0 GHz CENTER FREQ			
	1 MHz SPAN	4.999987 GHz		5.000013 GHz
	10 MHz SPAN	4.99958 GHz		5.00042 GHz
	50 MHz SPAN	4.99784 GHz		5.00216 GHz
	100 MHz SPAN	4.9958 GHz		5.0042 GHz
	2 GHz SPAN	4.919 GHz		5.081 GHz
	< R3272 ONLY >			
	11.0 GHz CENTER FREQ			
	1 MHz SPAN	10.999987 GHz		11.000013 GHz
	10 MHz SPAN	10.99958 GHz		11.00042 GHz
	50 MHz SPAN	10.99784 GHz		11.00216 GHz
	100 MHz SPAN	10.9958 GHz		11.0042 GHz
	2 GHz SPAN	10.919 GHz		11.081 GHz
18.0 GHz CENTER FREQ				
1 MHz SPAN	17.999986 GHz		18.000014 GHz	
10 MHz SPAN	17.99958 GHz		18.00042 GHz	
50 MHz SPAN	17.99784 GHz		18.00216 GHz	
100 MHz SPAN	17.9958 GHz		18.0042 GHz	
2 GHz SPAN	17.919 GHz		18.081 GHz	

Table 1-30 Performance Test Record (2 of 11)

Para. No.	Test Description	Results		
		Min.	Actual	Max.
1	Frequency Readout Accuracy and Marker Frequency Counter Accuracy (cont'd)			
	Marker Frequency Counter Accuracy			
	1.5 GHz CENTER FREQ	1.499999844 GHz		1.500000156 GHz
	5.0 GHz CENTER FREQ	4.999999494 GHz		5.000000506 GHz
	11.0 GHz CENTER FREQ	10.999998889 GHz		11.000001111 GHz
	18.0 GHz CENTER FREQ	17.999998184 GHz		18.000001816 GHz
2	Frequency Reference Output Accuracy			
	10 MHz Reference Frequency	29.9999970 MHz		30.0000030 MHz
3	Noise Sidebands			
	1.5 GHz Center Frequency			
	10 kHz Offset			- 100 dBc/Hz
	100 kHz Offset			- 110 dBc/Hz
	< R3465/3272 ONLY >			
	3.5 GHz Center Frequency			
10 kHz Offset			- 98 dBc/Hz	
100 kHz Offset			- 108 dBc/Hz	
4	Frequency Span Accuracy			
	1.5 GHz Center Frequency			
	5 MHz SPAN	3.96 MHz		4.04 MHz
	5.01 MHz SPAN	3.847 MHz		4.169 MHz
	40 MHz SPAN	30.72 MHz		33.28 MHz
	400 MHz SPAN	307.2 MHz		332.8 MHz
	< R3465/3272 ONLY >			
	4.0 GHz Center Frequency			
	4 GHz SPAN	3.072 GHz		3.328 GHz
	8 GHz SPAN	6.144 GHz		6.656 GHz
	< R3272 ONLY >			
10 GHz Center Frequency				
10 GHz SPAN	7.68 GHz		8.32 GHz	
19 GHz SPAN	15.36 GHz		16.64 GHz	

Table 1-30 Performance Test Record (3 of 11)

Para. No.	Test Description	Results		
		Min.	Actual	Max.
5	Resolution Bandwidth Accuracy and Selectivity			
	Resolution Bandwidth Accuracy			
	5 MHz	3.50 MHz		6.5 MHz
	3 MHz	2.1 MHz		3.9 MHz
	1 MHz	800 kHz		1.2 MHz
	300 kHz	240 kHz		360 kHz
	100 kHz	80 kHz		120 kHz
	30 kHz	24 kHz		36 kHz
	10 kHz	8.0 kHz		12.0 kHz
	3 kHz	2.4 kHz		3.6 kHz
	1 kHz	800 Hz		1200 Hz
	300 Hz	210 Hz		390 Hz
	Resolution Bandwidth Selectivity			
	5 MHz			15
	3 MHz			15
	1 MHz			15
	300 kHz			15
	100 kHz			15
	30 kHz			15
	10 kHz			15
3 kHz			15	
1 kHz			15	
300 Hz			15	

Table 1-30 Performance Test Record (4 of 11)

Para. No.	Test Description	Results		
		Min.	Actual	Max.
6	Resolution Bandwidth Switching Uncertainty			
	3 MHz	-0.3 dB	0 (Ref)	+0.3 dB
	1 MHz	-0.3 dB		+0.3 dB
	300 kHz			
	100 kHz	-0.3 dB		+0.3 dB
	30 kHz	-0.3 dB		+0.3 dB
	10 kHz	-0.3 dB		+0.3 dB
	3 kHz	-0.3 dB		+0.3 dB
	1 kHz	-0.3 dB		+0.3 dB
300 Hz	-0.3 dB	+0.3 dB		

Table 1-30 Performance Test Record (5 of 11)

Para. No.	Test Description	Results		
		Min.	Actual	Max.
7	Displayed Average Noise Level			
	<R3465 ONLY>			
	10 kHz			-70.0 dBm
	100 kHz			-80.0 dBm
	1.1MHz			-114.99 dBm
	101 MHz			-114.84 dBm
	501 MHz			-114.22 dBm
	1001 MHz			-113.45 dBm
	1501 MHz			-112.67 dBm
	2001 MHz			-111.90 dBm
	2501 MHz			-111.12 dBm
	2999 MHz			-110.35 dBm
	1.7 GHz to 7.0 GHz			-115 dBm
	6.9 GHz to 8.0 GHz			-115 dBm
	<R3272 ONLY>			
	10 kHz			-70.0 dBm
	100 kHz			-80.0 dBm
	1.1MHz			-114.99 dBm
	101 MHz			-114.84 dBm
	501 MHz			-114.22 dBm
	1001 MHz			-113.45 dBm
	1501 Hz			-112.67 dBm
	2001 MHz			-111.90 dBm
	2501 MHz			-111.12 dBm
	2999 MHz			-110.35 dBm
	3.0 GHz to 7.5 GHz			-110.0 dBm
	7.4 GHz to 15.4 GHz			-103.0 dBm
	15.2 GHz to 23.3 GHz			-96.0 dBm
	23 GHz to 26.5 GHz			-90.0 dBm
	<R3263/3463 ONLY>			
	10 kHz			-70.0 dBm
	100 kHz			-80.0 dBm
	1.1 MHz			-114.99 dBm
	101 MHz			-114.84 dBm
	501 MHz			-114.22 dBm
	1001 MHz			-113.45 dBm
	1501 MHz			-112.67 dBm
	2001 MHz			-111.90 dBm
	2501 MHz			-111.12 dBm
	2999 MHz			-110.35 dBm



Table 1-30 Performance Test Record (6 of 11)

Para. No.	Test Description	Results		
		Min.	Actual	Max.
8	Gain Compression 820.5 MHz	-5 dBm		
	<R3465/3272 ONLY> 3200.5 MHz	-5 dBm		
9	Residual Response 1 MHz to 3.0 GHz			-100 dBm
	<R3465 ONLY> 1.7 GHz to 8.0 GHz			-90 dBm
	<R3272 ONLY> 3.0 GHz to 26.5 GHz			-90 dBm
10	Second Harmonic Distortion INPUT FREQ: 1.4 GHz			-70 dBc
	INPUT FREQ: 1.9 GHz			-100 dBc
11	Third Order Intermodulation Distortion 820.005 MHz			( Mixer Input Level ) : -20dBm -55 dBc -55 dBc
	3200.005 MHz			
12	Image, Multiple, and Out-of-Band Response Maximum Response Amplitude			
	<R3465 ONLY> 10 MHz to 8 GHz			-70 dBc
	<R3272 ONLY> 10 MHz to 18 GHz			-70 dBc
	10 MHz to 23 GHz			-60 dBc
	10 MHz to 26.5 GHz			-50 dBc
	<R3263/3463 ONLY> 10 MHz to 3 GHz			-70 dBc

Table 1-30 Performance Test Record (7 of 11)

Para. No.	Test Description	Results		
		Min.	Actual	Max.
13	Frequency Response			
	<R3465 ONLY>			
	9 kHz to 3.0 GHz	-1.5 dB		+1.5 dB
	50 MHz to 3.0 GHz	-1.0 dB		+1.0 dB
	1.7 GHz to 7.5 GHz	-1.5 dB		+1.5 dB
	7.4 GHz to 8 GHz	-1.5 dB		+1.5 dB
	<R3272 ONLY>			
	9 kHz to 3.0 GHz	-1.5 dB		+1.5 dB
	50 MHz to 3.0 GHz	-1.0 dB		+1.0 dB
	3.0 GHz to 7.5 GHz	-1.5 dB		+1.5 dB
	7.4 GHz to 15.4 GHz	-3.5 dB		+3.5 dB
	15.4 GHz to 23.3 GHz	-4.0 dB		+4.0 dB
	23.0 GHz to 26.5 GHz	-4.0 dB		+4.0 dB
<R3263/3463 ONLY>				
9 kHz to 3.0 GHz	-1.5 dB		+1.5 dB	
50 MHz to 3.0 GHz	-1.0 dB		+1.0 dB	
14	IF Gain Uncertainty			
	RBW 10 kHz REF LEVEL			
	0 dBm			
	-1 dBm	-0.5 dB		+0.5 dB
	-2 dBm	-0.5 dB		+0.5 dB
	-3 dBm	-0.5 dB		+0.5 dB
	-4 dBm	-0.5 dB		+0.5 dB
	-5 dBm	-0.5 dB		+0.5 dB
	-6 dBm	-0.5 dB		+0.5 dB
	-7 dBm	-0.5 dB		+0.5 dB
	-8 dBm	-0.5 dB		+0.5 dB
	-9 dBm	-0.5 dB		+0.5 dB
	-10 dBm	-0.5 dB		+0.5 dB
	-20 dBm	-0.5 dB		+0.5 dB
-30 dBm	-0.5 dB		+0.5 dB	
-40 dBm	-0.5 dB		+0.5 dB	
-50 dBm	-0.5 dB		+0.5 dB	

Table 1-30 Performance Test Record (8 of 11)

Para. No.	Test Description	Results		
		Min.	Actual	Max.
14	IF Gain Uncertainty (cont'd)			
	RBW 3 kHz REF LEVEL			
	0 dBm			
	-1 dBm	-0.5 dB		+0.5 dB
	-2 dBm	-0.5 dB		+0.5 dB
	-3 dBm	-0.5 dB		+0.5 dB
	-4 dBm	-0.5 dB		+0.5 dB
	-5 dBm	-0.5 dB		+0.5 dB
	-6 dBm	-0.5 dB		+0.5 dB
	-7 dBm	-0.5 dB		+0.5 dB
	-8 dBm	-0.5 dB		+0.5 dB
	-9 dBm	-0.5 dB		+0.5 dB
	-10 dBm	-0.5 dB		+0.5 dB
	-20 dBm	-0.5 dB		+0.5 dB
-30 dBm	-0.5 dB		+0.5 dB	
-40 dBm	-0.5 dB		+0.5 dB	
-50 dBm	-0.5 dB		+0.5 dB	

Table 1-30 Performance Test Record (9 of 11)

Para. No.	Test Description	Results		
		Min.	Actual	Max.
15	Scale Fidelity			
	1 dB/div Log Scale Fidelity			
	-1 dB	-0.2 dB		+0.2 dB
	-2 dB	-0.4 dB		+0.4 dB
	-3 dB	-0.6 dB		+0.6 dB
	-4 dB	-0.8 dB		+0.8 dB
	-5 dB	-1.0 dB		+1.0 dB
	-6 dB	-1.2 dB		+1.2 dB
	-7 dB	-1.4 dB		+1.4 dB
	-8 dB	-1.5 dB		+1.5 dB
	-9 dB	-1.5 dB		+1.5 dB
	-10 dB	-1.5 dB		+1.5 dB
	10 dB/div Log Scale Fidelity			
	-10 dB	-1.0 dB		+1.0 dB
	-20 dB	-1.5 dB		+1.5 dB
	-30 dB	-1.5 dB		+1.5 dB
	-40 dB	-1.5 dB		+1.5 dB
	-50 dB	-1.5 dB		+1.5 dB
	-60 dB	-1.5 dB		+1.5 dB
	-70 dB	-1.5 dB		+1.5 dB
	-80 dB	-1.5 dB		+1.5 dB
	Linear Scale Fidelity			
	div from Ref Level			
	1	167.7 mV		234.8 mV
	2	145.3 mV		212.5 mV
	3	122.9 mV		190.1 mV
	4	100.6 mV		167.7 mV
	5	78.2 mV		145.4 mV
6	55.9 mV		122.0 mV	
7	33.5 mV		100.7 mV	
8	11.1 mV		78.3 mV	

Table 1-30 Performance Test Record (10 of 11)

Para. No.	Test Description	Results		
		Min.	Actual	Max.
16	Input Attenuator Accuracy			
	<R3465/3272 ONLY>			
	(4 GHz Center Freq)			
	Switching Accuracy			
	20 dB	-2 dB		+2 dB
	30 dB	-2 dB		+2 dB
	40 dB	-2 dB		+2 dB
	50 dB	-2 dB		+2 dB
	60 dB	-2 dB		+2 dB
	70 dB	-2 dB		+2 dB
	Step-to-Step Accuracy			
	20 dB	-1.1 dB		+1.1 dB
	30 dB	-1.1 dB		+1.1 dB
	40 dB	-1.1 dB		+1.1 dB
	50 dB	-1.1 dB		+1.1 dB
	60 dB	-1.1 dB		+1.1 dB
	70 dB	-1.1 dB		+1.1 dB
	<R3272 ONLY>			
	(15 GHz Center Freq)			
	Switching Accuracy			
	20 dB	-2.5 dB		+2.5 dB
	30 dB	-2.5 dB		+2.5 dB
	40 dB	-2.5 dB		+2.5 dB
	50 dB	-2.5 dB		+2.5 dB
	60 dB	-2.5 dB		+2.5 dB
	70 dB	-2.5 dB		+2.5 dB
	Step-to-Step Accuracy			
	20 dB	-1.3 dB		+1.3 dB
	30 dB	-1.3 dB		+1.3 dB
	40 dB	-1.3 dB		+1.3 dB
50 dB	-1.3 dB		+1.3 dB	
60 dB	-1.3 dB		+1.3 dB	
70 dB	-1.3 dB		+1.3 dB	
(18 GHz Center Freq)				
Switching Accuracy				
20 dB	-3.5 dB		+3.5 dB	
30 dB	-3.5 dB		+3.5 dB	
40 dB	-3.5 dB		+3.5 dB	
50 dB	-3.5 dB		+3.5 dB	
60 dB	-3.5 dB		+3.5 dB	
70 dB	-3.5 dB		+3.5 dB	

Table 1-30 Performance Test Record (11 of 11)

Para. No.	Test Description	Results		
		Min.	Actual	Max.
16	Input Attenuator Accuracy (cont'd)			
	< R3272 ONLY >			
	Step-to-Step Accuracy			
	20 dB	-1.8 dB		+1.8 dB
	30 dB	-1.8 dB		+1.8 dB
	40 dB	-1.8 dB		+1.8 dB
	50 dB	-1.8 dB		+1.8 dB
	60 dB	-1.8 dB		+1.8 dB
	70 dB	-1.8 dB		+1.8 dB
	< R3263/3463 ONLY >			
	(1.5 GHz Center Freq)			
	Switching Accuracy			
	20 dB	-2 dB		+2 dB
	30 dB	-2 dB		+2 dB
	40 dB	-2 dB		+2 dB
	50 dB	-2 dB		+2 dB
	60 dB	-2 dB		+2 dB
	70 dB	-2 dB		+2 dB
	Step-to-Step Accuracy			
	20 dB	-1.1 dB		+1.1 dB
30 dB	-1.1 dB		+1.1 dB	
40 dB	-1.1 dB		+1.1 dB	
50 dB	-1.1 dB		+1.1 dB	
60 dB	-1.1 dB		+1.1 dB	
70 dB	-1.1 dB		+1.1 dB	
17	Calibration Amplitude Accuracy	-10.3 dBm		-9.7 dBm

## **IMPORTANT INFORMATION FOR ADVANTEST SOFTWARE**

PLEASE READ CAREFULLY: This is an important notice for the software defined herein. Computer programs including any additions, modifications and updates thereof, operation manuals, and related materials provided by Advantest (hereafter referred to as "SOFTWARE"), included in or used with hardware produced by Advantest (hereafter referred to as "PRODUCTS").

### **SOFTWARE License**

All rights in and to the SOFTWARE (including, but not limited to, copyright) shall be and remain vested in Advantest. Advantest hereby grants you a license to use the SOFTWARE only on or with Advantest PRODUCTS.

### **Restrictions**

- (1) You may not use the SOFTWARE for any purpose other than for the use of the PRODUCTS.
- (2) You may not copy, modify, or change, all or any part of, the SOFTWARE without permission from Advantest.
- (3) You may not reverse engineer, de-compile, or disassemble, all or any part of, the SOFTWARE.

### **Liability**

Advantest shall have no liability (1) for any PRODUCT failures, which may arise out of any misuse (misuse is deemed to be use of the SOFTWARE for purposes other than its intended use) of the SOFTWARE. (2) For any dispute between you and any third party for any reason whatsoever including, but not limited to, infringement of intellectual property rights.

## LIMITED WARRANTY

1. Unless otherwise specifically agreed by Seller and Purchaser in writing, Advantest will warrant to the Purchaser that during the Warranty Period this Product (other than consumables included in the Product) will be free from defects in material and workmanship and shall conform to the specifications set forth in this Operation Manual.
2. The warranty period for the Product (the "Warranty Period") will be a period of one year commencing on the delivery date of the Product.
3. If the Product is found to be defective during the Warranty Period, Advantest will, at its option and in its sole and absolute discretion, either (a) repair the defective Product or part or component thereof or (b) replace the defective Product or part or component thereof, in either case at Advantest's sole cost and expense.
4. This limited warranty will not apply to defects or damage to the Product or any part or component thereof resulting from any of the following:
  - (a) any modifications, maintenance or repairs other than modifications, maintenance or repairs (i) performed by Advantest or (ii) specifically recommended or authorized by Advantest and performed in accordance with Advantest's instructions;
  - (b) any improper or inadequate handling, carriage or storage of the Product by the Purchaser or any third party (other than Advantest or its agents);
  - (c) use of the Product under operating conditions or environments different than those specified in the Operation Manual or recommended by Advantest, including, without limitation, (i) instances where the Product has been subjected to physical stress or electrical voltage exceeding the permissible range and (ii) instances where the corrosion of electrical circuits or other deterioration was accelerated by exposure to corrosive gases or dusty environments;
  - (d) use of the Product in connection with software, interfaces, products or parts other than software, interfaces, products or parts supplied or recommended by Advantest;
  - (e) incorporation in the Product of any parts or components (i) provided by Purchaser or (ii) provided by a third party at the request or direction of Purchaser or due to specifications or designs supplied by Purchaser (including, without limitation, any degradation in performance of such parts or components);
  - (f) Advantest's incorporation or use of any specifications or designs supplied by Purchaser;
  - (g) the occurrence of an event of force majeure, including, without limitation, fire, explosion, geological change, storm, flood, earthquake, tidal wave, lightning or act of war; or
  - (h) any negligent act or omission of the Purchaser or any third party other than Advantest.
5. **EXCEPT TO THE EXTENT EXPRESSLY PROVIDED HEREIN, ADVANTEST HEREBY EXPRESSLY DISCLAIMS, AND THE PURCHASER HEREBY WAIVES, ALL WARRANTIES, WHETHER EXPRESS OR IMPLIED, STATUTORY OR OTHERWISE, INCLUDING, WITHOUT LIMITATION, (A) ANY WARRANTY OF MERCHANTABILITY OR FITNESS FOR A PARTICULAR PURPOSE AND (B) ANY WARRANTY OR REPRESENTATION AS TO THE VALIDITY, SCOPE, EFFECTIVENESS OR USEFULNESS OF ANY TECHNOLOGY OR ANY INVENTION.**
6. **THE REMEDY SET FORTH HEREIN SHALL BE THE SOLE AND EXCLUSIVE REMEDY OF THE PURCHASER FOR BREACH OF WARRANTY WITH RESPECT TO THE PRODUCT.**
7. **ADVANTEST WILL NOT HAVE ANY LIABILITY TO THE PURCHASER FOR ANY INDIRECT, INCIDENTAL, SPECIAL, CONSEQUENTIAL OR PUNITIVE DAMAGES, INCLUDING, WITHOUT LIMITATION, LOSS OF ANTICIPATED PROFITS OR REVENUES, IN ANY AND ALL CIRCUMSTANCES, EVEN IF ADVANTEST HAS BEEN ADVISED OF THE POSSIBILITY OF SUCH DAMAGES AND WHETHER ARISING OUT OF BREACH OF CONTRACT, WARRANTY, TORT (INCLUDING, WITHOUT LIMITATION, NEGLIGENCE), STRICT LIABILITY, INDEMNITY, CONTRIBUTION OR OTHERWISE. TORT (INCLUDING, WITHOUT LIMITATION, NEGLIGENCE), STRICT LIABILITY, INDEMNITY, CONTRIBUTION OR OTHERWISE.**
8. **OTHER THAN THE REMEDY FOR THE BREACH OF WARRANTY SET FORTH HEREIN, ADVANTEST SHALL NOT BE LIABLE FOR, AND HEREBY DISCLAIMS TO THE FULLEST EXTENT PERMITTED BY LAW ANY LIABILITY FOR, DAMAGES FOR PRODUCT FAILURE OR DEFECT, WHETHER ARISING OUT OF BREACH OF CONTRACT, TORT (INCLUDING, WITHOUT LIMITATION, NEGLIGENCE), STRICT LIABILITY, INDEMNITY, CONTRIBUTION OR OTHERWISE.**



## **CUSTOMER SERVICE DESCRIPTION**

In order to maintain safe and trouble-free operation of the Product and to prevent the incurrence of unnecessary costs and expenses, Advantest recommends a regular preventive maintenance program under its maintenance agreement.

Advantest's maintenance agreement provides the Purchaser on-site and off-site maintenance, parts, maintenance machinery, regular inspections, and telephone support and will last a maximum of ten years from the date the delivery of the Product. For specific details of the services provided under the maintenance agreement, please contact the nearest Advantest office listed at the end of this Operation Manual or Advantest's sales representatives.

Some of the components and parts of this Product have a limited operating life (such as, electrical and mechanical parts, fan motors, unit power supply, etc.). Accordingly, these components and parts will have to be replaced on a periodic basis. If the operating life of a component or part has expired and such component or part has not been replaced, there is a possibility that the Product will not perform properly. Additionally, if the operating life of a component or part has expired and continued use of such component or part damages the Product, the Product may not be repairable. Please contact the nearest Advantest office listed at the end of this Operation Manual or Advantest's sales representatives to determine the operating life of a specific component or part, as the operating life may vary depending on various factors such as operating condition and usage environment.

## SALES & SUPPORT OFFICES

Advantest Korea Co., Ltd.

22BF, Kyobo KangNam Tower,  
1303-22, Seocho-Dong, Seocho-Ku, Seoul #137-070, Korea  
Phone: +82-2-532-7071  
Fax: +82-2-532-7132

Advantest (Suzhou) Co., Ltd.

Shanghai Branch Office:  
Bldg. 6D, NO.1188 Gumei Road, Shanghai, China 201102 P.R.C.  
Phone: +86-21-6485-2725  
Fax: +86-21-6485-2726

Shanghai Branch Office:  
406/F, Ying Building, Quantum Plaza, No. 23 Zhi Chun Road,  
Hai Dian District, Beijing,  
China 100083  
Phone: +86-10-8235-3377  
Fax: +86-10-8235-6717

Advantest (Singapore) Pte. Ltd.

438A Alexandra Road, #08-03/06  
Alexandra Technopark Singapore 119967  
Phone: +65-6274-3100  
Fax: +65-6274-4055

Advantest America, Inc.

3201 Scott Boulevard, Suite, Santa Clara, CA 95054, U.S.A  
Phone: +1-408-988-7700  
Fax: +1-408-987-0691

ROHDE & SCHWARZ Europe GmbH

Mühldorfstraße 15 D-81671 München, Germany  
(P.O.B. 80 14 60 D-81614 München, Germany)  
Phone: +49-89-4129-13711  
Fax: +49-89-4129-13723

**ADVANTEST®**

<http://www.advantest.co.jp>